



**T555.502 Bath/Shower Trim Shown with M962055 Decorative Screw Cover Plate**

**GENERAL DESCRIPTION:**

**TRIM KIT**

4-1/2" Rain showerhead at maximum 2.5gpm/9.5L/min. flow rate. Metal slip-on diverter spout. Available with metal lever handle. Metal wall escutcheon.

**ROUGH VALVE BODY**

Cast brass body, washerless ceramic disc valve cartridge with back to back capability, and hot limit safety stop. Cycles from "off" to "cold" to "hot". Pressure balancing cartridge maintains constant output temperature in response to changes in relative hot and cold supply pressure. 1/2" inlets and outlets (choice of direct sweat, threaded, or PEX). Available with screwdriver stops. Rough-in plaster guard designed for use as thin-wall mounting adaptor.

**Valve body will accept a variety of decorative Bath/Shower Trims**



**MODEL NUMBER:**

**TRIM KITS:**

- T555.502 Town Square BATH/SHOWER Trim Kit**  
Metal Lever Handle. LESS Valve Body.
- T555.501 Town Square SHOWER ONLY Trim Kit**  
Metal Lever Handle. LESS Valve Body.
- T555.500 Town Square VALVE ONLY Trim Kit**  
Metal Lever Handle. LESS Valve Body.

**ROUGH VALVES:**

- R110 Pressure Balance Rough Valve Body only**  
Direct sweat inlets/outlets. LESS trim.
- R110SS Pressure Balance Rough Valve Body only with Screwdriver stops**  
Direct sweat inlets/outlets. Screwdriver stops. LESS trim.
- R115 Pressure Balance Rough Valve Body only**  
Female thread inlets/outlets. LESS trim.
- R115SS Pressure Balance Rough Valve Body only with Screwdriver stops**  
Female thread inlets/outlets. Screwdriver stops. LESS trim.
- R117 Pressure Balance Rough Valve Body only**  
PEX inlets/Direct sweat outlets. LESS trim.
- R117SS Pressure Balance Rough Valve Body only with Screwdriver stops**  
PEX inlets/Direct sweat outlets. Screwdriver stops. LESS trim.

**ADDITIONAL ACCESSORY:**

- M962055 Decorative Screw Cover Plate**

**PRODUCT FEATURES:**

**Cast Brass Valve Body:** Durable - Quality that will last a lifetime. Ideal material for prolonged contact with water.

**Ceramic Disc Valve Cartridge:** Assures a lifetime of drip-free performance. Allows easy fine tuning of temperature (125° handle rotation from off to hot).

**Pressure Balancing Valve Cartridge:** Maintains constant output temperature in response to changes in hot and cold supply pressure. Diaphragm system engineered to eliminate cross flow. Avoids failure due to mineral deposits - ideal for use in hard water.

**Back-to-Back Capability:** Hot and cold can be reversed quickly and easily.

**Adjustable Hot Limit Safety Stop:** Limits the amount of hot water allowed to mix with cold. Reduces the risk of accidental scalding.

**Exclusive Plaster Guard:** Plaster guard is designed to protect valve during installation and serve as a mounting plate for thin-wall installations. 2 piece design allows valve to be tested prior to trim installation.

**Wide Rough-in Range:** From 1-5/8" to 3-1/4".

**SUGGESTED SPECIFICATION:**

Bath/shower fitting shall feature 4-1/2" rain showerhead with Max. 2.5gpm/9.5L/min. flow rate. Shall feature a cast brass valve body. Shall feature ceramic disc valve cartridge which is capable of back-to-back installation. Fitting shall be equipped with pressure balancing cartridge engineered to eliminate cross flow and avoid failure due to mineral deposits. Shall also feature a hot limit safety stop. Fitting shall be: Rough Valve Body - American Standard Model # R11\_\_\_\_, Trim Kit - American Standard Model # T555.50\_\_\_\_.

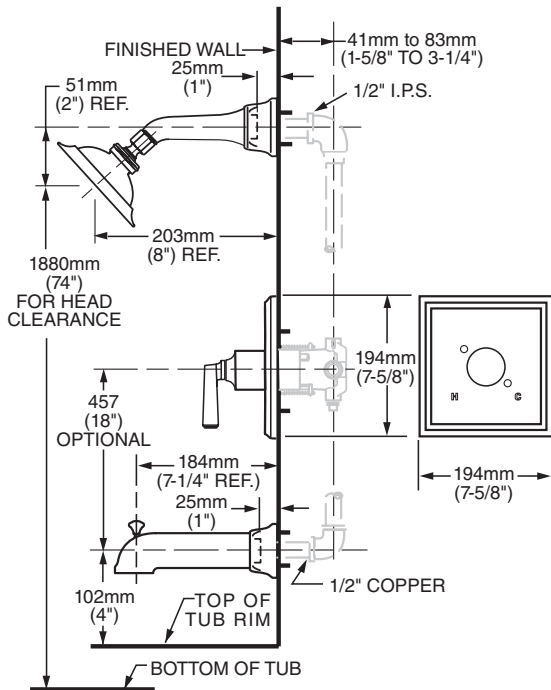

### VALVE BODY OPTIONS

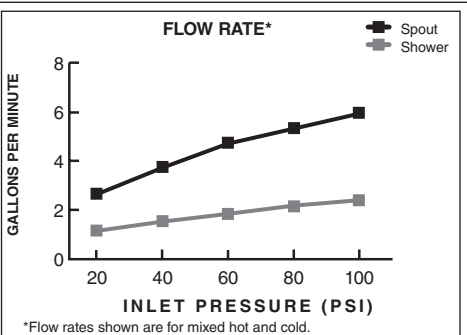
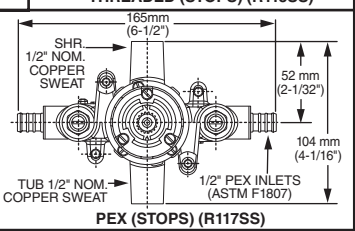
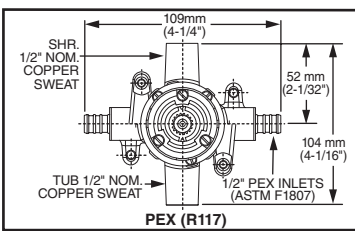
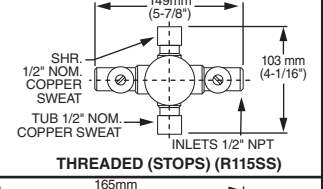
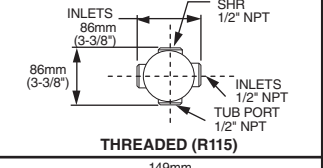
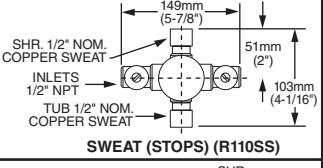
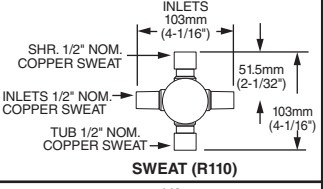

### CODES AND STANDARDS

These products meet or exceed the following codes and standards:

- ANSI A 117.1
- ASSE 1016
- ASME A112.18.1
- CSA B 125

Meets the American Disabilities Act Guidelines and **ANSI A117.1** Requirements for the physically challenged.

TRIM KITS *	Product Number	Description	Finish Options		
			Polished Chrome	Oil Rubbed Bronze	PVD Satin Nickel
			002	224	295
	T555.502	Bath/Shower Trim Kit. Metal Lever Handle. LESS Valve Body.			
	T555.501	Shower Only Trim Kit. Metal Lever Handle. LESS Valve Body.			
	T555.500	Valve Only Trim Kit. Metal Lever Handle. LESS Valve Body.			
	M962055	Decorative Screw Cover Plate			

ROUGH VALVE BODIES	Product Number	Description
	R110	Rough Valve Body less trim. Direct Sweat inlets/outlets.
	R110SS	Rough Valve Body less trim. Direct Sweat inlets/outlets with Screwdriver Stops.
	R115	Rough Valve Body less trim. Female Thread inlets/outlets.
	R115SS	Rough Valve Body less trim. Female Thread inlets/outlets with Screwdriver Stops.
	R117	Rough Valve Body less trim. PEX inlets/ Direct Sweat outlets.
	R117SS	Rough Valve Body less trim. PEX inlets/ Direct Sweat outlets with Screwdriver Stops.

\* TRIM & ROUGH MUST BE ORDERED SEPARATELY.