

## EZ Boost™ System

**USA** Installation and operating instructions



Please leave these instructions with the pump for future reference.

## 1. Pre-installation

- EZBoost System Guide ..... 1
- Function ..... 1
- Powerline Communication ..... 1

## 2. Built-in Protections

- Run Dry ..... 2
- Overload..... 2
- Over/under voltage ..... 2

## 3. Final Check

- Pumped Liquids..... 2
- Delivery and Transportation ..... 2
- Preparation ..... 2
- Sound Pressure Level..... 2

## 4. EZ Guide

- Quick Selection..... 3
- System Diagram ..... 3
- Installation ..... 4

## 5. Technical Data

- Operating Conditions ..... 6
- Storage ..... 6
- Frost Protection..... 6

## 6. Installation

- Electrical Connection..... 6
- Cable Sizing..... 7
- Positioning ..... 7
- Controller Connection..... 7
- Pressure Sensor..... 8
- Pressure Tank ..... 8
- Pressure Relief Valve ..... 8
- Liquid Fill and Pump Vent ..... 8
- Parallel Connection ..... 9
- Generator ..... 9

## 7. Operation

- Starting ..... 9
- Controller Functions ..... 9
- Alarms ..... 11
- Built-in Protection ..... 13

## 8. Service

- BMQE ..... 13
- Controller..... 13
- R100 ..... 14
- Fault Finding Chart ..... 14
- Instruments ..... 19
- Tests ..... 19

## 9. Factory Settings ..... 19

## 10. Pressure Sensor Voltage Chart ..... 20

## PRE-INSTALLATION



Before beginning installation procedures, these installation and operating instructions should be studied carefully. The installation and operation should also be in accordance with local regulations and accepted codes of good practice.

The sound pressure level of the BMQE is <74 db[A] at a distance of 3 feet (1 meter). **It is recommended by Grundfos that the pump be installed with sound and vibration dampening equipment such as; flexible piping adapters and anti-vibration mounting. The pump should not be mounted in or adjacent to living quarters. The pump can also be wrapped with sound proofing insulation to reduce noise. (See page 16, EZ Boost System Diagram.)**

### 1. A guide to the EZ Boost System

The EZ Boost Constant Pressure System automatically balances water surges and equalizes flow and pressure according to consumption. In other words, the system maintains a constant water pressure in spite of varying water consumption. The pressure is registered by means of the pressure sensor and transmitted to the controller. The controller adjusts the EZ Boost BMQE pump performance accordingly. The EZ Boost Constant Pressure System features:

- Quick and easy installation: ready-to-use system requiring minimum space
- High user convenience: constant pressure regardless of water consumption
- Easily adjustable pressure level: push button control
- Continuous control and monitoring of pump operation
- Integrated dry-running protection
- Integrated overload protection
- Integrated protection against over voltage and under voltage
- Soft start system

#### 1.1 Function

When a tap is opened, the pressure in the tank will start to drop. The system maintains a constant pressure within the maximum pump performance in spite of varying water consumption.

The pressure is registered by means of the pressure sensor, which transmits a signal to the controller. The controller adjusts the pump performance accordingly to maintain constant pressure by changing the pump speed.

At low flow the pressure will drop slowly. When the pressure in the tank is 7 PSI below the setpoint, the pump will

start. When the pressure is 7 PSI above the setpoint, the pump will stop.

Even though the EZ Boost controller is controlling the pressure within  $\pm 3$  PSI, larger pressure variations may occur in the system. If the consumption is suddenly changed, e.g. if a tap is opened, the water must start flowing before the pressure can be made constant again. Such dynamic variations depend on the pipe work, but, typically, they will lie between 7 and 14 PSI. If the desired consumption is higher than the quantity the pump is able to deliver at the desired pressure, the pressure follows the pump curve as illustrated in the far right of fig. 1.

Fig. 1

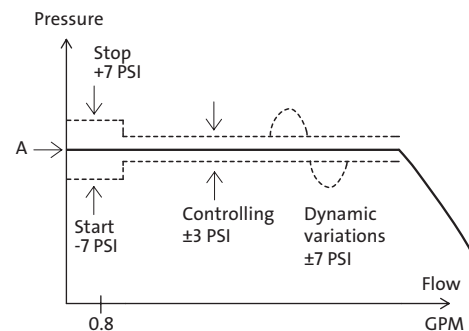

At large flow rates, the pressure will drop quickly and the pump will start immediately and maintain constant pressure. When the system is running, the EZ Boost controller makes small adjustments to the pressure to detect whether there is consumption. If there is none, the pump will simply refill the tank and stop after a few seconds.

#### 1.2 Power line communication

The communication between the EZ Boost controller and the EZ Boost BMQE pump is via the power supply cable. This communication principle is known as power line communication. Using this principle means that no additional cables to the pump are required. The communication of data is effected by means of a high-frequency signal transmitted to the power supply cable. **In situations where multiple EZ Boost BMQE pump power cables are run parallel in wiring trays or conduit and less than 12 inches apart, the possibility for undesired communication between units exists.** When this occurs, intermittent or continuous NO CONTACT is typically seen. Other unexpected errors may also be seen.

There are two ways to eliminate the possibility of cross communication:

1. Physical separation of the cables – maintain a minimum of 12 inches between pump power cables, and never place more than one cable in a conduit.
2. Use shielded cable – the use of shielded cable prevents cross communication between parallel cables and allows sharing of conduit and cable trays. Tie the cable shield to ground only at the EZ Boost controller panel.

Suitable cables:

Manufacturer	Part number	Gage
Anixter	2A-1403S	14
Anixter	2A-1203S	12
Anixter	2A-1003S	10
Anixter 800-321-1486		

## 2. Overview of built-in protection

### 2.1. Run-dry protection

The EZ Boost BMQE pumps are protected against dry-running. In case of dry-run, the BMQE will stop after an accumulated time of 5 seconds thus preventing a burnout of the motor. After a dry-running alarm, the pump restarts automatically after 5 min.

### 2.2. Overload protection

Exposure of the BMQE pump to heavy load causes the current consumption to rise. The motor will automatically compensate for this by reducing the speed. If the speed drops to 30% of the rated speed, the motor will be cut out. If the rotor is being prevented from rotating this will automatically be detected and the power supply cutout. Consequently, no extra motor protection is required.

### 2.3. Over voltage and under voltage protection

Over voltage and under voltage may occur if the voltage supply is unstable. The integrated protection of the BMQE motor protects the motor if the voltage falls outside the permissible voltage range. With a rated voltage of 200 - 240 V, 60 Hz, the pump will be cut out if voltage falls below 150 V or rises above 280 V. With a rated voltage of 110 - 115 V, 60 Hz, the pump will be cut out if voltage falls below 75 V or rises above 150 V. The motor is automatically cut in when the voltage is again within the permissible voltage range. Therefore, no extra voltage protection relay is required.

## 3. Final check

### 3.1. Pumped liquids



The EZ Boost BMQE must not be used for the transfer of flammable liquids such as diesel oil, petrol or similar liquids. The EZ Boost BMQE is designed for pumping thin, clean, non-aggressive, non-explosive liquids, not containing solid particles or fibers. The EZ Boost BMQE is suitable for pressure boosting clean, cool, potable water. The liquid must not attack the pump materials chemically or mechanically.

**Liquid temperature:** The temperature of the pumped liquid must not exceed +95°F (+35°C).

### Delivery and transportation

GRUNDFOS EZ Boost System components are supplied from the factory in proper packaging in which they should remain until they are to be installed. The components are ready for installation.

### 3.2. Preparation

Before installation, the following checks should be made:



- **Pump type:** Check that the pump type stated on the name-plate fitted to the module sleeve corresponds to order.
- **Electricity supply:** The motor voltage and frequency details stated on the nameplate should be compared with the actual electricity supply available.

### 3.3. Sound pressure level

The sound pressure level of the BMQE is <74 db[A] at a distance of 3 feet (1 meter). **It is recommended by Grundfos that the pump be installed with sound and vibration dampening equipment such as; flexible piping adapters and anti-vibration mounting. The pump should not be mounted in or adjacent to living quarters. The pump can also be wrapped with sound proofing insulation to reduce noise.**

## 4. EZ Boost Quick Guide

### 4.1. EZ Boost Quick Selection Guide

Example:

1. The maximum demand is 15 GPM (3.4 m<sup>3</sup>/h).
2. The pressure required is 70 PSI system pressure at the taps in the building.
3. The normal minimum inlet pressure (e.g. city pressure) is 20 PSI.
4. The additional boost required is 50 PSI at 15 GPM (3.4 m<sup>3</sup>/h).
5. Select a 15 BMQE 05A-110.

Additional (boost)  
pressure required  
in PSI

90	15 BMQE 07B-180	22 BMQE 10C-190						
80								
70								
60	15 BMQE 05A-110							
50		22 BMQE 05B-120						
40					30 BMQE 10C-130			
30		22 BMQE 05A-80				30 BMQE 10C-130		
20						30 BMQE 05B-90		
10								
	5	10	15	20	25	30	35	39
	Flow required in gallons per minute (GPM)							

### 4.2. EZ Boost System Diagram

The EZ Boost Constant Pressure System should consist of:

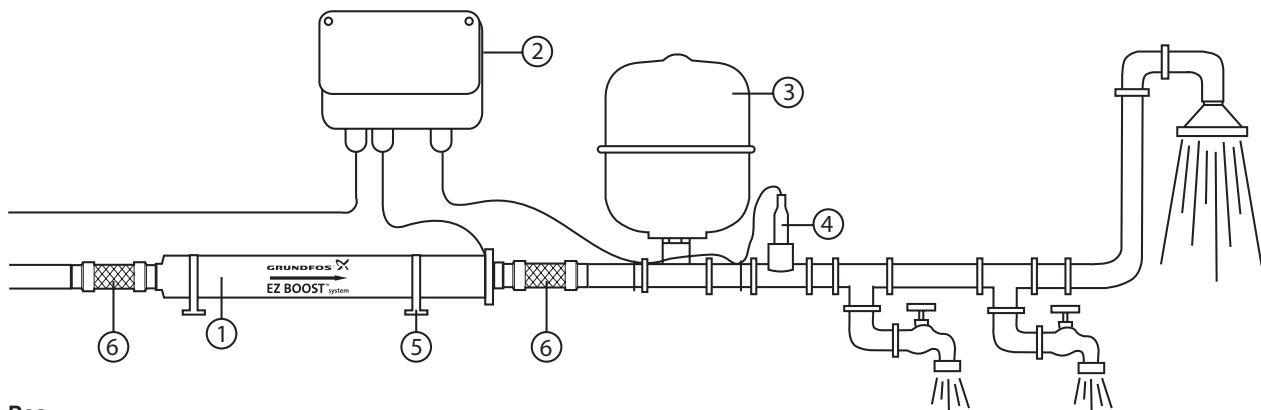

Pos.

- |  |                      |
|--|----------------------|
| 1. EZ Boost BMQE pump  | 4. Pressure sensor   |
| 2. EZ Boost controller   | 5. Mounting brackets |
| 3. Diaphragm tank<br>(recommended size 2 U.S. gallons (8 liter)/130 psi) | 6. Flex connector    |

## 4.3. EZ Boost Quick Installation Guide

FOR MORE DETAILED INSTALLATION INSTRUCTIONS, PLEASE GO TO SECTION 6.

**Note:** The BMQE pump must be installed with the air relief vent in the 12 o'clock position when installed horizontally, and when installed in the vertical position, the air vent must be at the top of the unit.

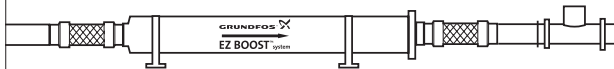

### 1. Install BMQE pump:

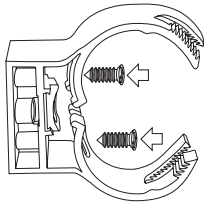

#### 1a. Secure mounting brackets

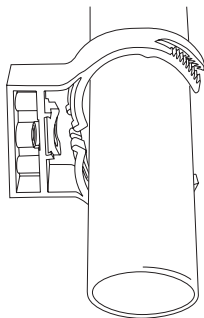

#### 1b. Insert BMQE pump into the open mounting bracket.

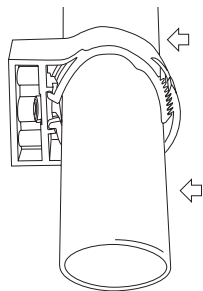

#### 1c. Apply pressure to the BMQE pump until the mounting bracket jaws close and lock.

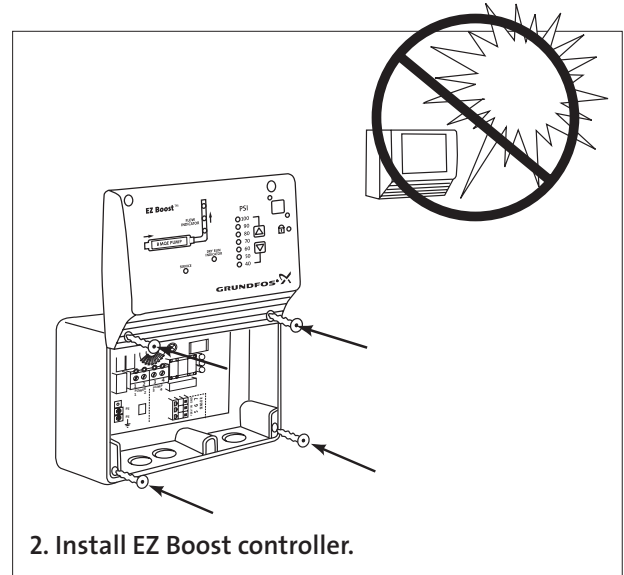

### 2. Install EZ Boost controller.

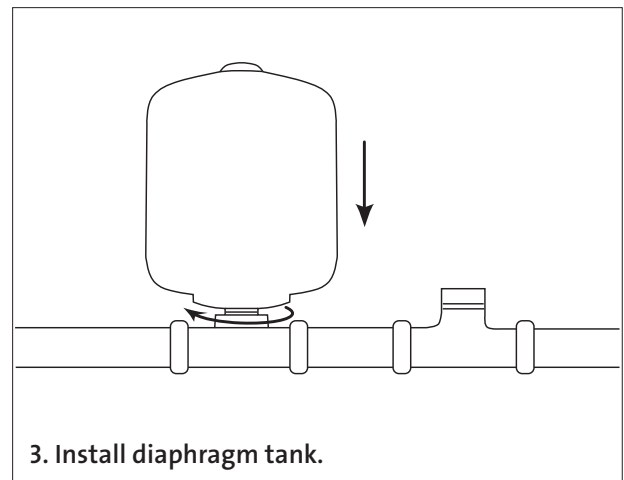

### 3. Install diaphragm tank.

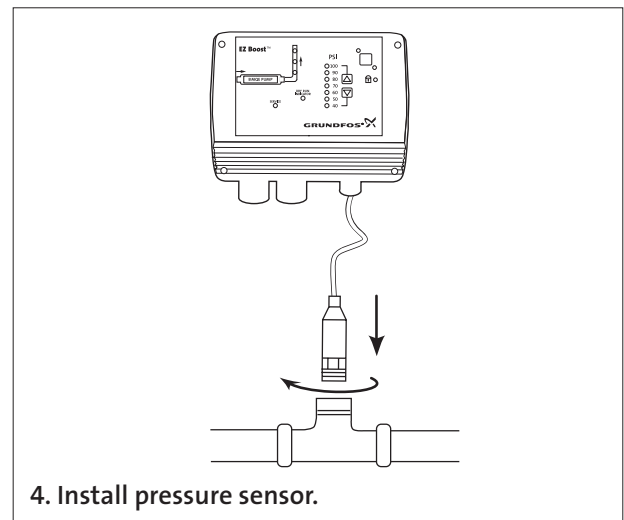

### 4. Install pressure sensor.

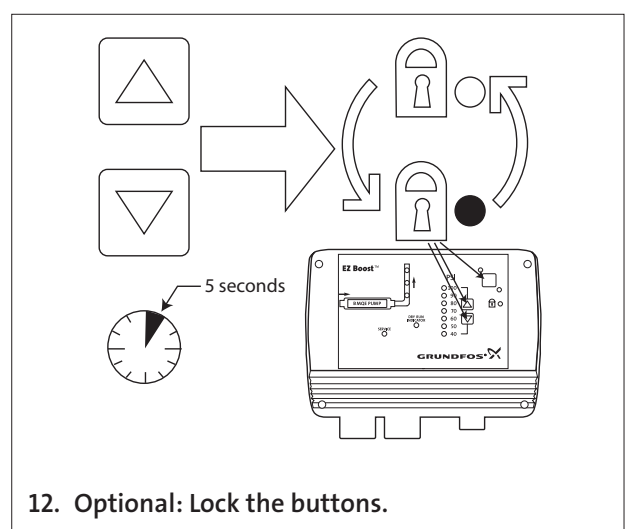
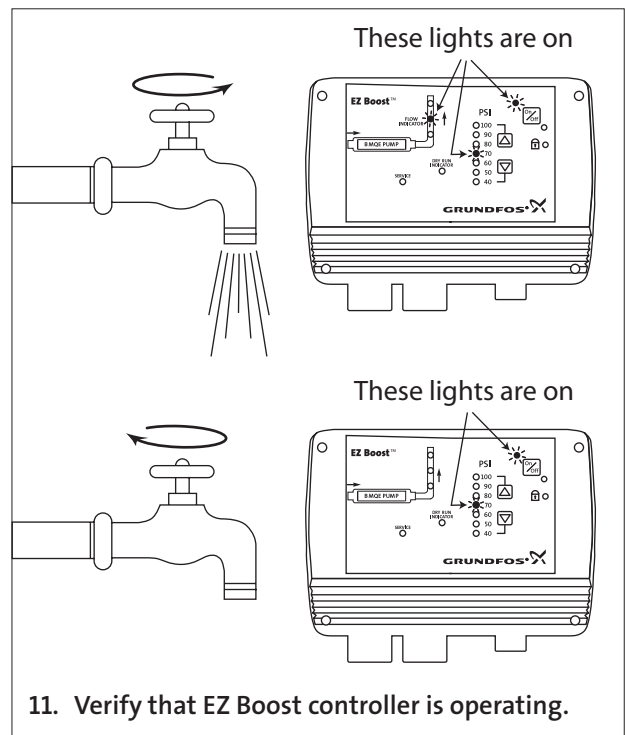
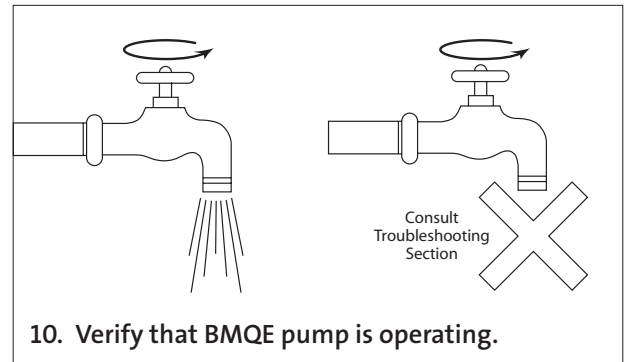
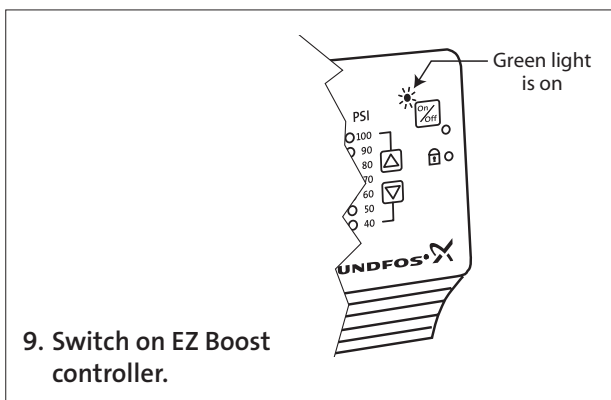
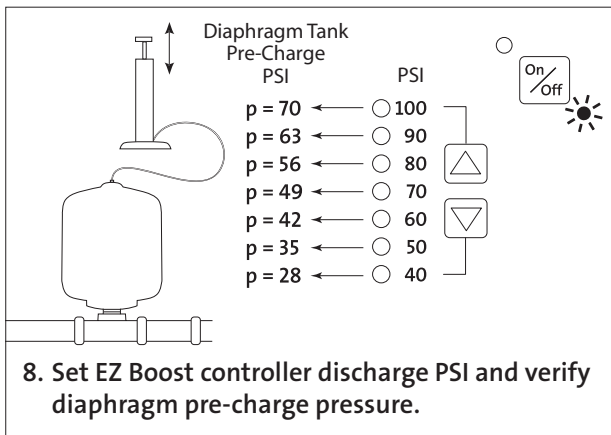
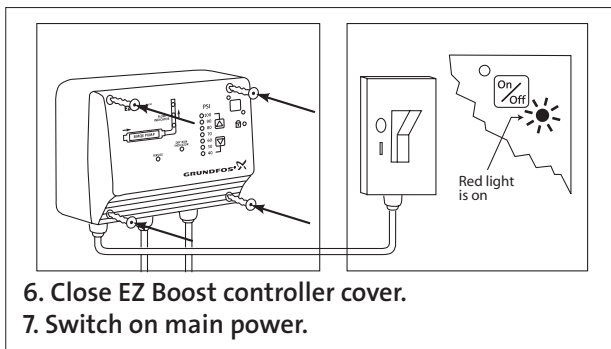
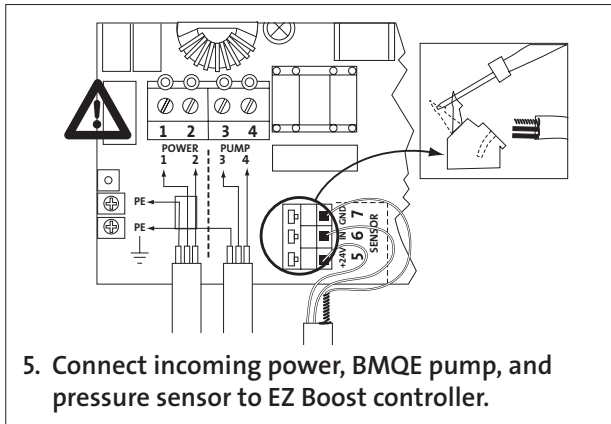

## 5. Technical data

### 5.1 Operating conditions

Supply voltage:	1 x 200-240 V -10%/+6%, 60 Hz 1 x 110-115 V -10%/+6%, 60 Hz
Fluid temperature:	Max. 95°F (35°C)
Starting current:	The motor starting current is equal to the highest value stated on the EZ Boost BMQE nameplate.
Power factor:	PF = 1.0
Motor cable:	<ul style="list-style-type: none"> <li>• 2-wire w/ground, 12 AWG Teflon</li> <li>• B: Black (Line, Neutral).</li> <li>• G: Green (Ground).</li> </ul>
EZ Boost BMQE inlet/discharge size:	1.25" NPT inlet / 1" NPT discharge.
EZ Boost BMQE maximum net weights:	31 lbs. (14.1 kg)

### 5.2. Storage

EZ Boost BMQE storage temperature:	+32°F to +140°F (0°C to +60°C).
EZ Boost controller storage temperature:	-22°F to +140°F (-30°C to +60°C).

### 5.3. Frost protection

If the BMQE has to be stored after use, it must be stored in a frost-free location or it must be ensured that the motor liquid is frost-proof. The BMQE is shipped from the factory with motor fluid that protects the motor down to -4°F (-20°C). The motor must not be stored without being filled with motor liquid.

## 6. Installation

### 6.1.1 Electrical connection



The electrical connection should be carried out by an authorized electrician in accordance with local regulations.

Before starting work on the EZ Boost controller or BMQE, make sure that the electricity supply has been switched off and that it cannot be accidentally switched on. The BMQE must be grounded. The EZ Boost controller must be connected in accordance with the local rules and regulations.

**IMPORTANT:** The on/off button on the EZ Boost controller must not be used as a safety switch when installing and servicing the pump.

Rain-tight or wet location hubs that comply with the requirements in the standard for Fittings for Conduit and Outlet Boxes, UL514B, are to be used. Suitable devices for EZ Boost controller are rated with enclosure type 3, 3R, 3S, 4, 4X, 6 or 6P.

The supply voltage and frequency are marked on the nameplate. Make sure that the EZ Boost controller and BMQE pump are suitable for the electricity supply on which they will be used.

The current consumption can only be measured by means of a true RMS instrument. If other instruments are used, the value measured will differ from the actual value.

All EZ Boost BMQE pumps can be connected to EZ Boost controllers. Each BMQE pump must be connected to its own EZ Boost controller.



### CAUTION!

The EZ Boost BMQE must never be connected to a capacitor or to another type of control box than EZ Boost controller.

The EZ Boost BMQE must never be connected to an external frequency converter.

**Motor protection:** The EZ Boost BMQE incorporates thermal overload protection and requires no additional motor protection.

**Connection of motor:** The EZ Boost BMQE incorporates a starter device and can therefore be connected directly to the main power supply.



### WARNING!

Reduced risk of electric shock during operation of this EZ Boost system requires the provision of acceptable grounding. If the means of connection to the supply connected box is other than grounded metal conduit, ground the pump back to the service by connecting a copper conductor, at least the size of the circuit supplying the pump.



## 6.1.2. Cable sizing

\* Single-phase 60 HZ maximum cable length motor service to entrance

Motor rating		Copper wire size (AWG)		
Volts	HP	14	12	10
Maximum cable length [ft/m]				
115	0.50	100/30.5	160/48.8	250/76.2
230	0.50	400/121.9	650/198.1	650/198.1
	0.75	300/91.4	480/146.3	650/198.1
	1.0	250/76.2	400/121.9	630/192

\* The maximum cable length with one EZ Boost Controller is 650' and the maximum wire size is 10 AWG.

In situations where multiple EZ Boost power cables are run parallel in wiring trays or conduit and less than 12 inches apart, the possibility for undesired communication between units exists. When this occurs, intermittent or continuous NO CONTACT is typically seen. Other unexpected errors may also be seen. Refer to section 1.2 and 8.4, #5 for further instructions.

## 6.2. Positioning the BMQE pump

The GRUNDFOS EZ Boost BMQE pump is supplied with a built-in non-return valve. An arrow on the BMQE sleeve shows the direction of liquid flow through the pump, fig. 3.

The BMQE is suitable for both vertical and horizontal installation, however, the discharge port should never fall below the horizontal plane, see fig. 4.

The BMQE must be installed with the air relief vent in the 12 o'clock position when installed horizontally and when installed in the vertical position, the air vent must be at the top of the unit.

Fig. 3

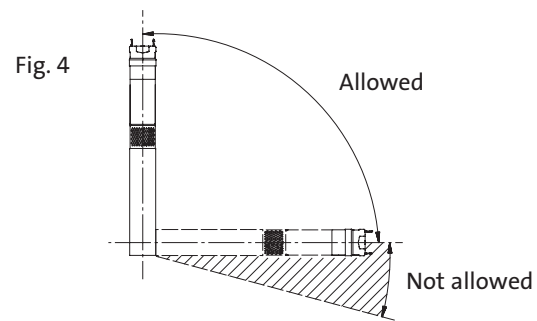
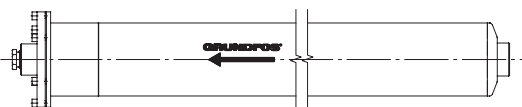

## 6.3. EZ Boost controller connection

The EZ Boost controller has two terminal blocks:

- Terminals 1 to 4.
- Terminals 5 to 7.

Furthermore, the EZ Boost controller is equipped with two screw terminals for the ground leads.

### 6.3.1. Main power supply, POWER, terminals 1, 2 and PE (ground):

Connect terminals 1 and 2 to the line and neutral leads of the main supply. Each terminal can be connected to any of the two leads.

**NOTE:** Circuit breaker: Maximum 16 A.

**IMPORTANT:** The main power supply cables must not be connected to terminals 3 and 4 (PUMP).

### 6.3.2. Motor leads, PUMP, terminals 3, 4 and PE (ground):

Connect terminals 3 and 4 to the line and neutral leads of the pump. Each terminal can be connected to any of the two leads.

### 6.3.3. NOTES:

Connect one PE terminal to the green ground lead from the pump and one to the ground lead from the main power supply. Each PE terminal must be connected to its own ground lead.

Maximum wire size of the cables to be connected to EZ Boost controller is 10 AWG.

### 6.4. Positioning the pressure sensor

Pressure losses often cause inconvenience to the user. The EZ Boost controller keeps the pressure constant in the place where the pressure sensor is positioned (see EZ Boost System Diagram on page 16). In the diagram tap 1 is placed close to the pressure sensor. Therefore, the pressure will be kept nearly constant at tap 1, as the friction loss is small. At the shower and tap 2, the friction loss is greater. This, of course, depends on the piping. Therefore, it is recommended that the pressure sensor be positioned as close to the places of consumption as possible. The maximum shielded cable length for the sensor must not exceed 1600 feet.

#### 6.4.1 Connection of the pressure sensor

##### SENSOR, terminals 5, 6 and 7:

Terminals 5, 6 and 7 (SENSOR) are used for the pressure sensor.

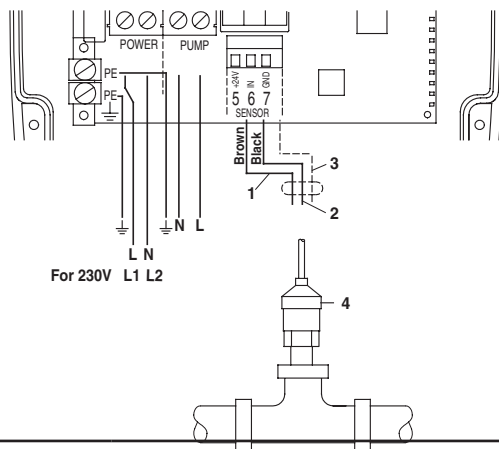

Pos.	Description
1	Standard pressure sensor.+ 24 VDC, brown lead, terminal 5.
2	Standard pressure sensor. Input signal, black lead, terminal 6.
3	Standard pressure sensor. Braid, terminal 7.

#### Sensor signals:

The pressure sensor to be connected provides a 4-20 mA signal (factory setting).

### 6.5. Diaphragm Pressure Tank

The EZ Boost controller is designed to work with a 2 gal. diaphragm tank. Install a diaphragm tank to insure that the BMQE will shut off at zero flow. The diaphragm tank must be installed at some point between the BMQE pump and the pressure sensor.

#### 6.5.1 Pre-charge Pressure Setting

The pre-charge pressure of the diaphragm tank must be set to 70% of the pressure setting in order to use the tank to the limit of its capacity.

Use the values in the following table. Pre-charge pressure is measured with 0 PSI in the pipeline:

Setting (PSI)	Pre-charge pressure (PSI)
40	28
50	35
60	42
70	49
80	56
90	63
100	70

**Note:** If the pre-charge pressure is higher than the pressure setting, the system will have difficulty controlling the pressure.

If the user wants to adjust the pressure without changing the pre-charge pressure of the diaphragm tank, the pre-charge pressure must be equal to the lowest pressure setting used. Failure to follow this instruction will increase pressure fluctuations.

#### 6.6. Pressure Relief Valve

In order to provide protection against the possibility of over pressurization, a pressure relieve valve may be installed down stream of the BMQE. If a relief valve is installed, it is recommended that its discharge be plumbed into an appropriate drainage point.

#### 6.7. Liquid filling and BMQE pump venting

The BMQE is filled with water through the suction port by the water in the piping system.

1. The BMQE should be installed with the air relief vent in the 12 o'clock position when installed horizontally and when installed in the vertical position the air vent must be at the top of the unit.
2. Loosen the air vent screw in the BMQE pump.
3. Fill the BMQE with water until it starts running out of the vent hole.
4. Tighten the air vent screw.

## 6.8. BMQE pumps connected in parallel

**6.8.1.** When connecting BMQE pumps in parallel as shown in fig. 5, **a separate EZ Boost controller must be used on each BMQE.** Set the pressure on one BMQE 10 PSI lower than the other.

**6.8.2.** For BMQE pumps connected in parallel, mounted above each other, it is recommended to connect the pipes as shown in fig. 5. This layout ensures that the BMQE pumps are filled with water before starting.

Fig. 5 Booster unit with two BMQE pumps connected in parallel, mounted above each other.

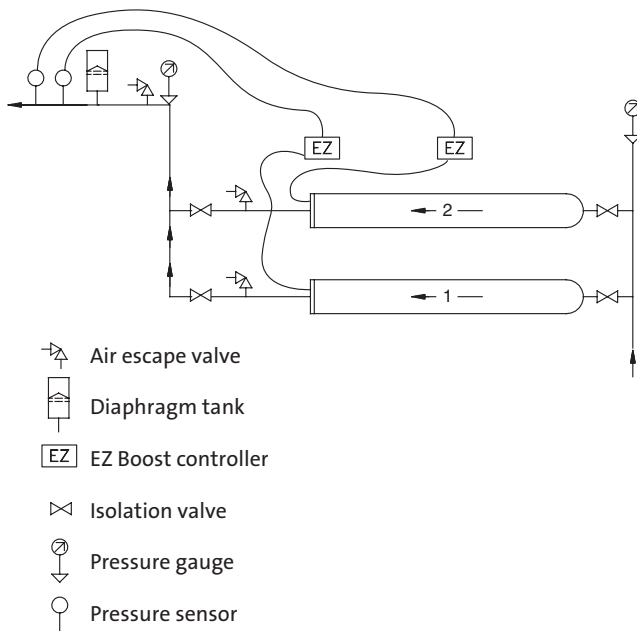

### 6.8.3. Notes:

- All BMQE modules are supplied with a non-return valve.
- BMQE modules connected in parallel may also be installed vertically.
- As venting problems may arise in such installations, it is advisable to install suitable air vent devices.
- The BMQE should be positioned with the discharge and air vent at the top when installed vertically.
- When the maximum flow for BMQE pumps in parallel will exceed 35 GPM, a 4-gallon or two 2-gallon diaphragm tank(s) should be used.

## 6.9. Generator Operation

Power may be supplied to BMQE pumps by an adequately sized generator. The generator must be sized 50% above the pumps P1 (input power) values. See following chart.

Motor HP	Minimum generator size	Recommended generator output (watts)
0.33 to 0.50 A	1100	1500
0.50 to 0.75 B	1700	2300
1.0 to 1.5 B	2000	3500

## 7. Operation

### 7.1. Starting the BMQE Pump for the First Time

When the BMQE has been connected correctly, it should be started with the discharge valve closed approximately one-third. Due to the soft start feature, the pump takes approximately 2 seconds to develop full pressure.

Check that the actual inlet pressure is equal to or greater than the previously estimated inlet pressure.

When not being used, all modules should be filled with water as all internal bearings are water lubricated.

If the BMQE is taken out of operation for a long period, the BMQE should be flushed through with clean water. The modules are then left with clean water until they are to be used again.

### 7.2. EZ Boost Controller Operating Functions

#### 7.2.1 On/off button

Fig.6 shows the on/off button of the EZ Boost controller.

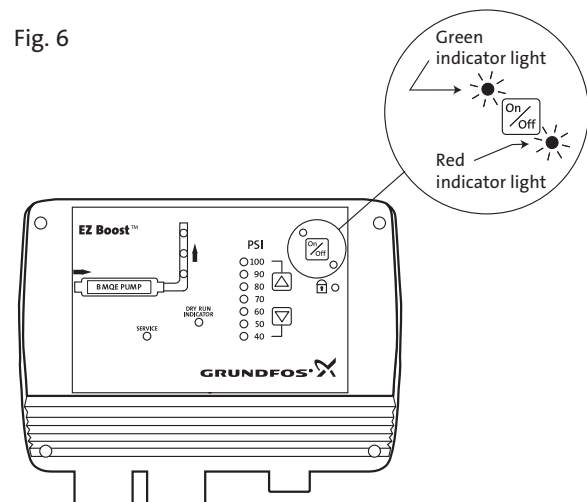

The green and red indicator lights in the on/off button indicate pump operating condition as follows:

Indication	Description
Green indicator light permanently on.	The system is operational.
Green indicator light off.	The system is not operational.
Red indicator light permanently on.	Pump has been stopped by means of the On/Off button.*

\*If the on/off button has been used to stop the pump, this button must also be used for restarting.

Any alarm indication can be reset by pressing the on/off button.

If the on/off button is pressed for more than 5 seconds, the pump is started, irrespective of any active fault/alarm indications and sensor signals.

When the on/off button is released, the pump will stop, if the alarm still exists.

### IMPORTANT:

Setting this button to the OFF position DOES NOT remove power from the pump. Before servicing the pump, remove power at the service breaker.

### 7.2.2. Indication of pump operation

On the graphical illustration on the EZ Boost controller face, the pipe shows run lights when the pump is operating. When the pump is not operating, none of the flow indicator lights are on, see fig. 7.

Fig. 7

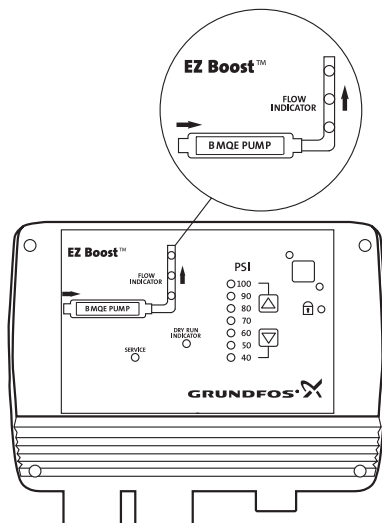

### 7.2.3 Pressure setting

The two arrow buttons on the EZ Boost controller front are used for the pressure setting, see fig. 8.

Fig. 8

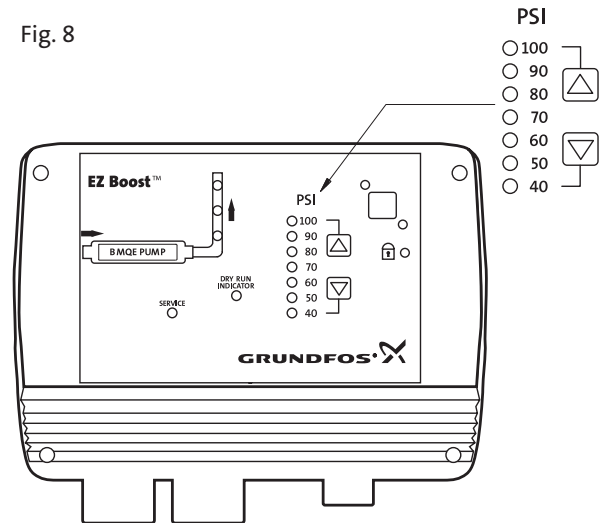

#### 7.2.3.1 Indication of pressure setting:

The system pressure set is indicated by a yellow indicator light, which is permanently on. Setting range: 40-100 PSI.

#### 7.2.3.2 Arrow-up button:

When this button is pressed, the system pressure setting is increased in steps of 10 PSI.

#### 7.2.3.3 Arrow-down button:

When this button is pressed, the system pressure setting is decreased in steps of 10 PSI.

#### 7.2.3.4. Button locking

The buttons on the EZ Boost controller can be locked/unlocked by pressing the two arrow buttons simultaneously for 5 seconds.

**NOTE:** When the arrow buttons are used for locking, take care not to inadvertently change the pressure setting. When the buttons are locked, the indicator light is permanently on, see fig. 9.

You can use the following procedure:

1. Set the pressure one step up.
2. Press the arrow-down button as the first one when pressing the two buttons.

Fig. 9

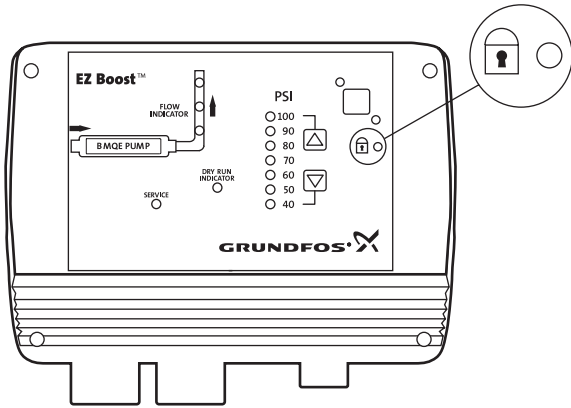

## 7.3. Alarm Functions

The EZ Boost controller continuously receives operating data from the pump. The alarm functions indicated on the EZ Boost controller front are described in the following sections.

### 7.3.1. Service alarm

If one or more factory-set alarm values are exceeded, the indicator light for service alarm is permanently on, see fig. 10.

Fig. 10

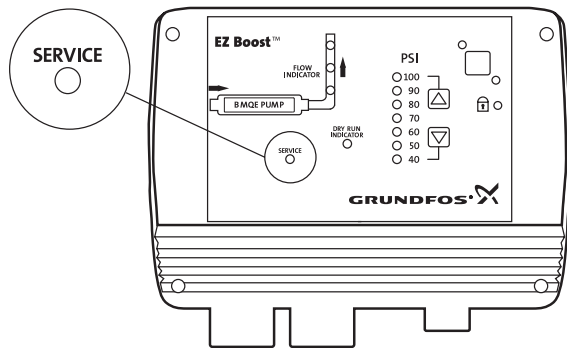

Possible alarms:

- Sensor defective.
- Overload.
- Over temperature.
- Speed reduction.
- Voltage alarm.
- No contact to pump.

The possible alarms and how to identify them and make the relevant corrections are described in section 8.2 and 8.4, Service.

### 7.3.2. Dry-running protection

The purpose of the dry-running protection is to protect the pump in case of insufficient water flow.

The dry-running protection makes the conventional dry-running protection unnecessary.

No additional cables to the motor are required. The dry run settings shown in section 9, Factory Settings, are built into the pump and automatically transmitted to the EZ Boost controller.

When air enters the pump together with water, the pump power decreases, and pressure drops, causing the motor to increase speed. If the power consumption falls below the dry run setting for an accumulated time of 5 seconds, and the motor speed is within 1000 rpm of the max speed the EZ Boost controller stops the pump and declares a dry run alarm.

When the motor is stopped, the dry-running indicator light is permanently on, see fig. 11.

Fig. 11

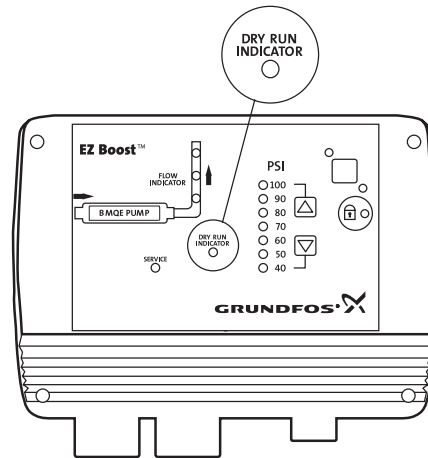

Possible cause	Remedy
The pump performance is too high compared to the inlet yield.	Replace the pump with a smaller one.
In line filter or BMQE screen is blocked.	Filter or BMQE service is required.

### Restarting:

After 5 minutes (factory setting), the motor will restart automatically.

### 7.3.3. Position of LED's

Fig. 12

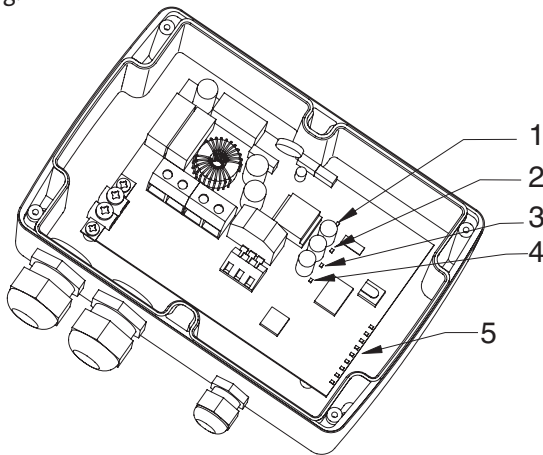

Pos.	Indication	Description
1	+24 V overload	Permanent red light when the internal 24 VDC supply is overloaded.
2	+24 V	Permanent green light when the internal 24 VDC supply is OK.
3	+10 V	Permanent green light when the internal 10 VDC supply is OK.
4	+5 V	Permanent green light when the internal 5 VDC supply is OK.
5	9 indicator lights:	(see Fig. 14)
	• Control indicator	• Flashing green light when the pump control is working correctly.
	• Min. speed	• Permanent yellow light when the pump is running at minimum speed, 3,000 rpm
	• Max. speed	• Permanent yellow light when the pump is running at maximum speed, 10,700 rpm.
	• Sensor defective	• Permanent red light when the sensor signal is out of signal range.
	• Overload*	• Permanent red light when the motor load exceeds the stop limit, see section 9, Factory Settings.
	• Over temperature*	• Permanent red light when the motor temperature exceeds the stop limit, see section 9, Factory Settings.
	• Speed reduction*	• Permanent red light when the pump speed is reduced, see section 9, Factory Settings.
	• Voltage alarm*	• Permanent red light when the supply voltage is out of range, see section 9, Factory Settings.
	• No contact to pump *	• Permanent red light when communication between the EZ Boost controller and the pump is impossible.

\* Press the on/off button to reset the alarm indication.

## 7.4. EZ Boost BMQE Built-in Protection

The EZ Boost BMQE incorporates an electronic unit which protects the motor in various situations.

- In case of overload, the built-in overload protection will stop the BMQE for 5 minutes. After that period, the booster module will attempt to restart.
- If started without water (dry running), the BMQE will stop after 30 seconds.
- If stopped as a result of dry running, the BMQE will start automatically after 5 minutes.

The motor is protected against the following conditions:

- Dry running
- Voltage surges (up to 4000 V)
- Under voltage
- Over voltage
- Overload
- Over temperature

### 7.4.1. Restarting the BMQE pump

To reset the EZ Boost BMQE, switch off the electricity supply for 1 minute.

## 8. EZ Boost System Service

### 8.1. EZ Boost BMQE Service

For the replacement and repair of parts of the EZ Boost BMQE, please refer to:

1. Service instructions for SQE pumps describing replacement of motor cable and motor.
2. Parts list for SQE with instructions for dismantling and assembly of pump and motor.

### 8.2. EZ Boost Controller Service



Before starting any work on the EZ Boost controller, make sure that the electricity supply has been switched off and that it cannot be accidentally switched on.

The EZ Boost controller continuously receives operating data from the pump. In case of an alarm, the service indicator light is permanently on, see fig. 13.

Fig. 13

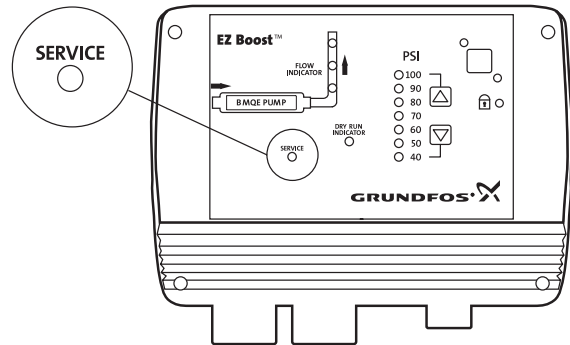

The service indicator light will be permanently on if one of the following alarm situations occurs:

- Sensor defective.
- Overload.
- Over temperature.
- Speed reduction.
- Voltage alarm.
- No contact to pump.

To identify the cause of the service alarm, it is necessary to remove the front cover from the EZ Boost controller. Fit the front cover as shown in fig. 14 to avoid disconnecting the multi-core cable.

A number of LED's are mounted on the supply board inside the EZ Boost controller, see section 7.3.3. Position of LED's.

Fig. 14 shows the LED's and the alarm texts on the supply board.

Fig. 14

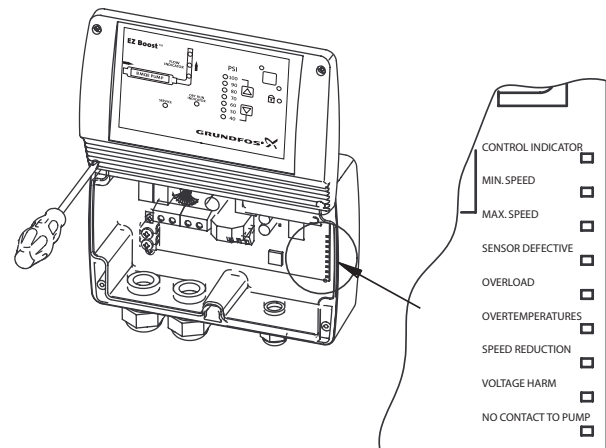

### 8.2.1 EZ Boost Optional R100 Interface

The R100 remote control can be used as a supplement for the installer and as an excellent troubleshooting tool. Grundfos highly recommends the use of one for diagnosing problems and accessing system information unavailable through other means. The R100 provides wireless communication with the Controller.

Note: It is not necessary to use the R100 to operate the system. The R100 offers additional features.

The R100 communicates via infrared light. During communication, there must be visual contact between the Controller and the R100. The best visual contact between the two units is obtained by pointing the R100 at the lower arrow button or by removing the front cover and pointing the R100 at the right side of the Controller.

The R100 offers possibilities of altering factory settings and reviewing operating status of the pump. When the communication between the R100 and Controller has been established, the red indicator light in the On/Off button will flash.

For general use of the R100, see the operating instructions included with it.

### 8.3. EZ Boost BMQE fault finding chart

Fault	Possible Cause	Remedy
1. The BMQE does not run.	a) The GFI or the voltage-operated GFI has tripped out.	Cut in the circuit breaker.
	b) No electricity supply.	Contact the electricity supply company.
	c) The motor protection has cut off the electricity supply due to over-load.	Check whether the motor/pump is blocked.
	d) The pump/cable is defective.	Repair/replace the pump/cable.
	e) Over voltage has occurred.	Check the electricity supply.
2. The BMQE runs but gives no water.	a) The discharge valve is closed.	Open the valve.
	b) The suction strainer is choked up.	Pull the pump out of the sleeve and clean the strainer.
	c) The pump is defective.	Pull the pump out of the sleeve and repair/replace the pump.
3. The BMQE runs at reduced capacity.	a) The valves in the discharge pipe are partly closed/blocked.	Check and clean/replace the valves, if necessary.
	b) The discharge pipe is partly choked by impurities.	Clean/replace the discharge pipe.
	c) The pump is partly choked by impurities.	Pull the pump out of the sleeve. Check and clean or replace the pump, if necessary. Clean the pipes.
	d) The pump is defective.	Pull the pump out of the sleeve and repair/replace the pump.
	e) Leakage in the pipe work.	Check and repair the pipe work.
	f) Under voltage has occurred.	Check the electricity supply.
4. Frequent starts and stops.	a) The supply voltage is unstable.	Check the electricity supply.
	b) The motor temperature becomes too high.	Check the water temperature.



## 8.4. EZ Boost controller fault finding chart

Fault	Possible Cause	Remedy
1. No light in the front cover.	a) The ribbon cable connection is loose or defective.	<ul style="list-style-type: none"> <li>Is the control indicator LED flashing? If not, the EZ Boost controller is defective.</li> <li>Check that the ribbon cable connection is secure.</li> </ul>
2. The pump does not start. The green indicator light in the on/off button is on. No alarm is indicated.	a) The EZ Boost controller, the pressure sensor or the pump is defective.	<p>Check :</p> <ul style="list-style-type: none"> <li>That the control indicator LED is flashing. If not, the EZ Boost controller is defective.</li> <li>That the system pressure is 7 PSI below the pressure setting. If so, the pump is supposed to start. Open a tap to be sure. If the pump starts, the system is probably OK. The system pressure can be read on the pressure gauge.</li> <li>Refer to fault 13 to troubleshoot the pressure sensor. If the pump has not started yet, proceed as follows: Press the on/off button for 5 seconds. If the pump starts, the EZ Boost controller or the sensor may be defective. <b>Note:</b> The pressure is not controlled and may rise to a high level.</li> </ul>
3. The pressure is not constant.	<p>a) The pump is not of the correct type or the pre-charge pressure of the diaphragm tank is incorrect.</p> <p>b) No contact between BMQE pump and EZ Boost controller.</p>	<p>Check</p> <ul style="list-style-type: none"> <li>That the LED for Max. speed or Min. speed is on. If so, this indicates that the pump has reached a limit. See section 3, EZ Boost Quick Select Guide. Replace the pump, if necessary.</li> <li>The pre-charge pressure of the diaphragm tank. <b>Note: Remember to stop and drain the system pressure before the pressure is checked.</b></li> <li>Make sure the diaphragm tank is the 2 gal. size.</li> <li>Whether the sensor is positioned far away from the tap. If so, the pressure variations may be caused by friction losses, see section 6.4, Positioning the Pressure Sensor.</li> <li>Check that the LED for “No contact to pump” is on. If so, go to fault no. 14.</li> </ul>

(continued next page)

## 8.4. EZ Boost controller fault finding chart (continued)

Fault	Possible Cause	Remedy
4. The pump is running continuously.	a) The pump cannot deliver the set pressure. The EZ Boost controller or the sensor is defective.	<ul style="list-style-type: none"> <li>• Try to lower the pressure setting, see section 7.2.3. Note that the pump may run for about 15 to 20 seconds before it stops.</li> <li>• Check that the control indicator LED is flashing.</li> <li>• Check that the pipe end of the sensor is not blocked. If so, remove the blockage.</li> <li>• Try to stop the pump by means of the on/off button. If this is not possible, the EZ Boost controller is defective. Replace the EZ Boost controller.</li> <li>• Refer to fault 13 to troubleshoot the pressure sensor.</li> </ul>
5. The EZ Boost controller indicates “No contact to pump”.	a) The pump cable is longer than 650 feet. b) Cable breakage	<ul style="list-style-type: none"> <li>• Reduce the length of the pump cable.</li> <li>• Switch off the main power supply to the EZ Boost controller. Switch on the main power supply again. The pump is now connected direct to the main power supply without interference from the EZ Boost controller.</li> </ul>
	c) Cross communication with adjacent EZ Boost controller.	<p>Does the motor start?  <b>Yes:</b> The cable is OK. Go to point d).  <b>No:</b> Switch off the mains supply again. Remove cable and cable plug from the motor and ohm out cable including plug.                      Is the cable OK?  <b>Yes:</b> The motor is defective. Replace the motor.  <b>No:</b> Replace the cable.</p> <p>If another EZ Boost controller is installed:</p> <ul style="list-style-type: none"> <li>• If pump cables run parallel to each other physically separate them by 12 - 14 inches (305-355 mm) or rewire using shielded cable.</li> </ul>
	d) The EZ Boost controller communication part is defective.	<p>Are the three EZ Boost controller supply board LED's in pos. 2, 3 and 4 on and is the control indicator LED flashing? See section 7.3.3.</p> <p><b>Yes:</b> The mains supply is OK.                      Is the LED “No contact to pump” of the new EZ Boost controller also on?  <b>Yes:</b> The EZ Boost controller is OK. Go to point e).  <b>No:</b> The EZ Boost controller which was removed is defective.</p>
	e) The BMQE motor communication part is defective.	<ul style="list-style-type: none"> <li>• As a consequence of the above mentioned checks, replace the BMQE motor.</li> </ul>

(continued next page)

## 8.4. EZ Boost controller fault finding chart (continued)

Fault	Possible Cause	Remedy
6. Even AFTER replacement, the EZ Boost controller indicates “No contact to pump”.	a) Numbering of BMQE pump and EZ Boost controller is different.	<ul style="list-style-type: none"> <li>If an BMQE/ EZ Boost controller system has been given a number, this number is stored in both the BMQE and EZ Boost controller. A new EZ Boost controller or BMQE may not have a number corresponding to the number stored in the previous unit. Therefore, “No contact to pump” is indicated even if there is no fault. Give the new system the number used in the previous unit in order to obtain correspondence between the numbering of the BMQE pump and the EZ Boost controller. This requires an R100.</li> </ul> <p><b>Note:</b> Two systems on the same main power supply must not have the same number!</p>
7. The EZ Boost controller indicates “Over voltage” or “Under voltage”.	a) The supply voltage is unstable or outside the voltage range specified for the installed motor type.	<ul style="list-style-type: none"> <li>Check: Possibly over a period of time - that the supply voltage is according to the values in Section 5.</li> </ul> <p><b>Note:</b> As the voltage is detected at the motor, allow for the voltage drop in the pump cable.</p>
8. The EZ Boost controller indicates “Dry running”.	<p>If the power consumption is lower than the dry-running stop setting and the motor speed is within 1000 rpm of programmed maximum speed, for an accumulated period of 5 seconds, the pump will be stopped.</p> <p>a) The pump performance is too high for the inlet yield.</p> <p>b) The well screen is blocked.</p>	<ul style="list-style-type: none"> <li>Replace the pump with a smaller pump or reduce the pump performance, by lowering maximum speed, or reducing set pressure.</li> <li>Check the well capacity and restore water supply to the well.</li> </ul>
9. The EZ Boost controller indicates “Speed reduction” and “Under voltage”.	<p>Speed reduction is activated so as to maintain a reduced performance. When the supply voltage falls so low that it can no longer supply the necessary current to maintain 3,000 rpm, the pump will be stopped.</p> <p>a) The supply voltage is unstable or lower than the voltage range specified for the installed motor type.</p> <p>b) The pump is not of the correct type.</p> <p>c) The voltage drop in the pump cable is too great.</p>	<ul style="list-style-type: none"> <li>Restore correct supply voltage.</li> <li>Install correct pump type.</li> <li>Replace the pump cable with lower gauge wires or reduce cable length.</li> </ul>

(continued next page)

## 8.4. EZ Boost controller fault finding chart (continued)

Fault	Possible Cause	Remedy
10. The EZ Boost controller indicates “Speed reduction” and “Overload”.	Speed reduction is activated so as to maintain a reduced performance a) The pump is worn or blocked. b) The pump is too large for the installed motor.	<ul style="list-style-type: none"> <li>The pump must be serviced.</li> <li>Replace pump or motor.</li> </ul>
11. The EZ Boost controller indicates “Over temperature”.	The temperature sensor in the motor is sensing a temperature above the values stated in Section 9, Factory settings: a) Insufficient cooling of the motor.	<ul style="list-style-type: none"> <li>Restore correct cooling of the motor. The flow velocity past the motor should be at least 0.5 ft/s (0.15 m/s).</li> </ul>
12. The EZ Boost controller indicates “Overload”.	a) The pump is worn or blocked. b) The pump is too large for the installed motor.	<ul style="list-style-type: none"> <li>The pump must be serviced.</li> <li>Replace pump or motor.</li> </ul>
13. The EZ Boost controller indicates “Sensor defective”.	a) The pressure sensor is defective.	<ul style="list-style-type: none"> <li>Check that the sensor is wired correctly. If the sensor type is 4-20 mA, measure the DC voltage across the sensor input terminals. If the DC voltage measured at the sensor input terminals is not between 2 and 10 volts the sensor, or wiring is defective. Refer to Section 10, Pressure Sensor Voltage Chart. Replace defective parts. Are the LED “Sensor defective” and the LED, pos. 1, on? See section 7.3.3., Position of LED’s.</li> </ul> <p><b>Yes:</b> The total load of 24 VDC from terminal 5 is above 100 mA. Disconnect the sensor in order to determine if it is defective. Replace defective sensor.</p> <p><b>No:</b> The load is OK, but the EZ Boost controller sensor input may be defective.</p>
14. The pump is operating on/off.	a) No communication.	<ul style="list-style-type: none"> <li>Check that the LED “No contact to pump” is on.</li> </ul> <p>If so, the control unit EZ Boost controller starts and stops the pump, based on the sensor signal only. The EZ Boost controller has to be reset after each 250 stop.- see fault no. 5 for remedy</p>

## 8.5. Instruments not allowed

**Note:** The use of the following instruments is not allowed during fault finding:



**Note:** When measuring, use RMS-instruments.

## 8.6. Checking of motor and cable

### 1. Supply voltage

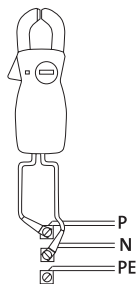

Measure the voltage (RMS) between line and neutral. Connect the voltmeter to the terminals at the connection.

When the motor is loaded, the voltage should be within the range specified in section 5, Technical Data.

Large variations in supply voltage indicate poor electricity supply, and the BMQE should be stopped until the defect has been remedied.

### 2. Current consumption

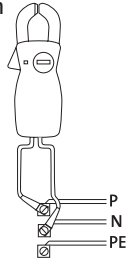

Measure the current (RMS) while the pump is operating at a constant discharge head (if possible, at the capacity where the motor is most heavily loaded).

For maximum current, see nameplate.

If the current exceeds the full load current, there are the following possible faults:

- Poor connection in leads, possibly in the cable joint.
- Too low supply voltage, see item 1.

## 9. Factory settings

Alarm	200-240 V motors			100-115 V motors
	SQ/SQE/SQE-NE 03A and 05A models	SQ/SQE/SQE-NE05B and 07B models	SQ/SQE/SQE-NE1.0C and 1.5C models	All models
Sensor defective	4-20 mA (the value is stored in the EZ Boost controller)			
Overload	5.2 A	8.4 A	12.0 A	12.0 A
Over temperature	Stop limit: 163°F (73°C)	Stop limit: 162°F (72°C)	Stop limit: 203°F (95°C)	Stop limit: 185°F (85°C)
	Restart: 145°F (63°C)	Restart: 144°F (62°C)	Restart: 185°F (85°C)	Restart: 167°F (75°C)
Speed reduction	In connection with under voltage or overload			
Over voltage *)	315 VAC	315 VAC	315 VAC	180 VAC
Under voltage	Speed reduction: 198 V Stop limit: 150 V	Speed reduction: 198 V Stop limit: 150 V	Speed reduction: 198 V Stop limit: 150 V	Speed reduction: 90 V Stop limit: 75 V
Dry-running	300 W	680 W	800 W	300 W

\*) 200-240 V motors: Operation is guaranteed up to 280 VAC, 100-115 V motors: Operation is guaranteed up to 150 VAC. In order to avoid unnecessary stops, the over voltage stop limit is as stated.

## 10. Pressure sensor voltage chart

Voltage to pressure chart for EZ Boost pressure sensors. Measure DC voltage between Sensor IN and Sensor Ground. Voltages less than 2 or greater than 10 indicate an incorrectly wired or a faulty sensor.

DC voltage	psi	DC voltage	psi	DC voltage	psi
1.9	0.0	4.5	40.5	7.1	81.0
2.0	0.7	4.6	41.2	7.2	81.7
2.0	1.5	4.6	42.0	7.2	82.5
2.1	2.2	4.7	42.7	7.2	83.2
2.1	3.0	4.7	43.5	7.3	84.0
2.2	3.7	4.8	44.2	7.3	84.7
2.2	4.5	4.8	45.0	7.4	85.5
2.3	5.2	4.8	45.7	7.4	86.2
2.3	6.0	4.9	46.5	7.5	87.0
2.4	6.7	4.9	47.2	7.5	87.7
2.4	7.5	5.0	48.0	7.6	88.5
2.4	8.2	5.0	48.7	7.6	89.2
2.5	9.0	5.1	49.5	7.7	90.0
2.5	9.7	5.1	50.2	7.7	90.7
2.6	10.5	5.2	51.0	7.8	91.5
2.6	11.3	5.2	51.7	7.8	92.2
2.7	12.0	5.3	52.5	7.9	93.0
2.7	12.8	5.3	53.2	7.9	93.7
2.8	13.5	5.4	54.0	8.0	94.5
2.8	14.3	5.4	54.7	8.0	95.2
2.9	15.0	5.5	55.5	8.1	96.0
2.9	15.7	5.5	56.2	8.1	96.7
3.0	16.5	5.6	57.0	8.2	97.5
3.0	17.2	5.6	57.7	8.2	98.2
3.1	18.0	5.7	58.5	8.3	99.0
3.1	18.7	5.7	59.2	8.3	99.7
3.2	19.5	5.8	60.0	8.4	100.5
3.2	20.2	5.8	60.7	8.4	101.3
3.3	21.0	5.9	61.5	8.4	102.0
3.3	21.7	5.9	62.2	8.5	102.8
3.4	22.5	6.0	63.0	8.5	103.5
3.4	23.2	6.0	63.7	8.6	104.3
3.5	24.0	6.0	64.5	8.6	105.0
3.5	24.7	6.1	65.2	8.7	105.8
3.6	25.5	6.1	66.0	8.7	106.5
3.6	26.2	6.2	66.7	8.8	107.3
3.6	27.0	6.2	67.5	8.8	108.0
3.7	27.7	6.3	68.2	8.9	108.8
3.7	28.5	6.3	69.0	8.9	109.5
3.8	29.2	6.4	69.7	9.0	110.3
3.8	30.0	6.4	70.5	9.0	111.0
3.9	30.7	6.5	71.2	9.1	111.8
3.9	31.5	6.5	72.0	9.1	112.5
4.0	32.2	6.6	72.7	9.2	113.3
4.0	33.0	6.6	73.5	9.2	114.0
4.1	33.7	6.7	74.2	9.3	114.8
4.1	34.5	6.7	75.0	9.3	115.5
4.2	35.2	6.8	75.7	9.4	116.3
4.2	36.0	6.8	76.5	9.4	117.0
4.3	36.7	6.9	77.2	9.5	117.8
4.3	37.5	6.9	78.0	9.5	118.5
4.4	38.2	7.0	78.7	9.6	119.3
4.4	39.0	7.0	79.5	9.6	120.0
4.5	39.7	7.1	80.2		

## LIMITED WARRANTY

Products manufactured by GRUNDFOS PUMPS CORPORATION (GRUNDFOS) are warranted to the original user only to be free of defects in material and workmanship for a period of 24 months from date of installation, but not more than 30 months from date of manufacture. GRUNDFOS' liability under this warranty shall be limited to repairing or replacing at GRUNDFOS' option, without charge, F.O.B. GRUNDFOS' factory or authorized service station, any product of GRUNDFOS' manufacture. GRUNDFOS will not be liable for any costs of removal, installation, transportation, or any other charges which may arise in connection with a warranty claim. Products which are sold but not manufactured by GRUNDFOS are subject to the warranty provided by the manufacturer of said products and not by GRUNDFOS' warranty. GRUNDFOS will not be liable for damage or wear to products caused by abnormal operating conditions, accident, abuse, misuse, unauthorized alteration or repair, or if the product was not installed in accordance with GRUNDFOS' printed installation and operating instructions.

To obtain service under this warranty, the defective product must be returned to the distributor or dealer of GRUNDFOS' products from which it was purchased together with proof of purchase and installation date, failure date, and supporting installation data. Unless otherwise provided, the distributor or dealer will contact GRUNDFOS or an authorized service station for instructions. Any defective product to be returned to GRUNDFOS or a service station must be sent freight prepaid; documentation supporting the warranty claim and/or a Return Material Authorization must be included if so instructed.

GRUNDFOS WILL NOT BE LIABLE FOR ANY INCIDENTAL OR CONSEQUENTIAL DAMAGES, LOSSES, OR EXPENSES ARISING FROM INSTALLATION, USE, OR ANY OTHER CAUSES. THERE ARE NO EXPRESS OR IMPLIED WARRANTIES, INCLUDING MERCHANTABILITY OR FITNESS FOR A PARTICULAR PURPOSE, WHICH EXTEND BEYOND THOSE WARRANTIES DESCRIBED OR REFERRED TO ABOVE.

Some jurisdictions do not allow the exclusion or limitation of incidental or consequential damages and some jurisdictions do not allow limitations on how long implied warranties may last. Therefore, the above limitations or exclusions may not apply to you. This warranty gives you specific legal rights and you may also have other rights which vary from jurisdiction to jurisdiction.



L-EZ-TL-001 3/08 (US)  
Subject to alterations