

SPECIFICATION SUBMITTAL SHEET

jones stephens corporation

ADJUSTABLE URINAL FLANGE KIT



features and benefits:

- Socket fits over 2" Schedule 40 DWV pipe
- Spigot fits inside hub of fitting
- 3 1/2" - 7" flange mounting centers

This product and others like it can be found in the Jones Stephens catalog. Call today to order your catalog or download it from our website: www.plumbest.com

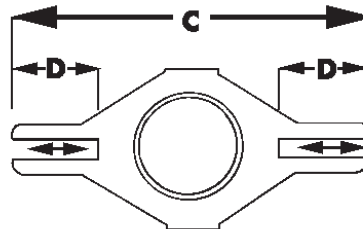
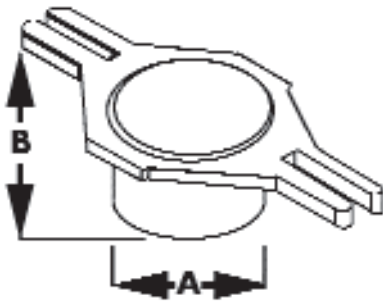

TOP VIEW OF FLANGE

PVC	ABS	DESCRIPTION	A	B	C	D
<input type="checkbox"/> F10-001	<input type="checkbox"/> F10-002	Spigot	2 3/8"	1 13/16"	7"	1 11/16"
<input type="checkbox"/> F11-001	<input type="checkbox"/> F11-002	Socket/Hub	2 11/16"	1 1/2"	7"	1 11/16"

jones stephens corporation
 3249 moody parkway • moody, alabama 35004
 toll free phone: 1-800-355-6637 • toll free fax: 1-800-462-6991
www.plumbest.com