

216NS/217 Maple

Vitreous China, Under Counter Lavatories





Features

- Model 216NS: 17-1/8" x 14-1/4" Petite oval, under counter lavatory
Basin: 15-1/8" x 12-1/4"
Model 217: 19-3/4" x 16" oval, under counter lavatory
Basin: 17-5/16" x 14-1/8"
- Complies with ADA requirements for accessibility
- Concealed Front Overflow
- Mansfield® Limited Lifetime Warranty
- Available in White and Standard Colors: Biscuit and Bone



Model 217 shown
Less mounting clips, drain
assembly and supply

Components

Model #	Description	Codes/Standards
216NS	Petite oval, under counter lavatory. Less mounting clips, drain assembly and supply. Specify color.	 
217	Oval, under counter lavatory. Less mounting clips, drain assembly and supply. Specify color.	



216NS/217

Maple

Vitreous China, Under Counter Lavatories



Specifications

Model #	Description	Codes/Standards
216NS	Petite oval, under counter lavatory (17-1/8" x 14-1/4")	 
217	Oval, under counter lavatory (19-3/4" x 16")	

Specification	Description	Specification	Description
Material	Vitreous China	Shipping Weight	Model 216NS - 15 lbs. (6 kg)
Warranty	Vitreous China - Limited Lifetime		Model 217 - 18 lbs. (8 kg)

Technical Information

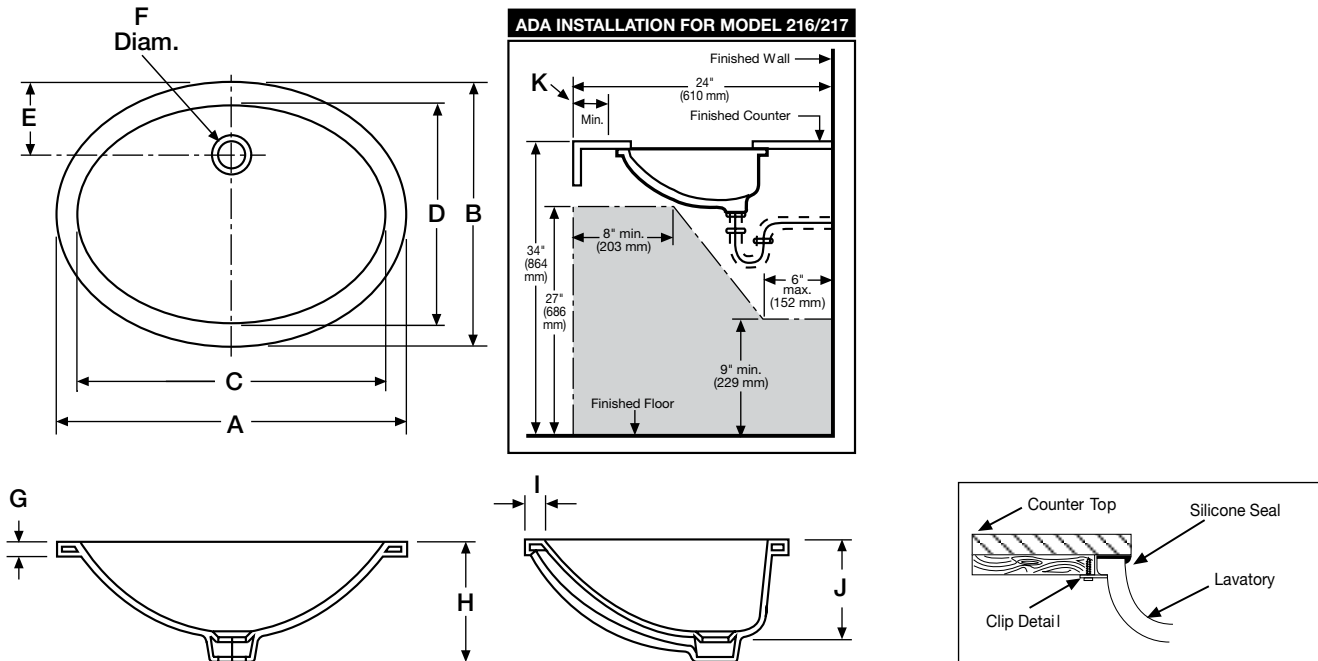

Model	A	B	C	D	E	F	G	H	I	J	K
216NS	17-1/8"	14-1/4"	15-1/8"	12-1/4"	3-5/8"	1-1/2"	1/2"	7-1/2"	1-3/8"	6-1/8"	1/2"
217	19-3/4"	16"	17-3/16"	14-1/8"	3-1/4"	1-3/4"	1/2"	7-1/8"	1-1/8"	5-1/2"	1/2"

Model	A	B	C	D	E	F	G	H	I	J	K
216NS	435 mm	362 mm	387 mm	311 mm	92 mm	38 mm	13 mm	191 mm	35 mm	156 mm	13 mm
217	502 mm	406 mm	440 mm	359 mm	83 mm	44 mm	13 mm	181 mm	29 mm	140 mm	13 mm

See our complete line of acrylic and vitreous china bathroom fixtures, plastic tank trim and plumbing products.

These dimensions are nominal and subject to change without notice.

Fixture performance and specifications meet or exceed ASME A112.19.2-2008/CSA B45.1-08 standards, and other state and local codes.