

# Models 9028/9128/9228 Baywood 5.5™

Ariance® Rectangular Air Massage Bath







## Features

- 66" x 36" x 19-3/4" Rectangular air massage bath
- Three advanced therapy air bath systems
- Multifunctional digital controller
- Chromatherapy system — Seven healing light settings with a full spectrum sequencing mode
- PerfectBack™ — Multiple soothing recessed back jets with heated neck/back rest
- Heated SilentAir™ system
- QuickDrain™ channel system and automatic purge system
- Color-Match trim for air jets — Optional finishes available
- Cable drain with matching trim (optional)
- Decorative handles
- One pillow
- Removable apron (optional)
- Mansfield® Limited Ten Year Warranty
- Available in standard colors (white, almond, biscuit and bone) and premium colors (British khaki, sterling silver, black and ice gray)

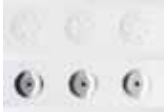

Model 9228

## Options

Cable Drain			Metal Trim		
Model #	Description		Model #	Description	
SW1319	Standard Colors		AR1335	Chrome	
SW1320	Polished Chrome		AR1336	Everbrass (PVD)	
SW1321	Everbrass (PVD)		AR1337	Brushed Nickel	
SW1322	Brushed Nickel		AR1338	Oil Rubbed Bronze	
SW1323	Oil Rubbed Bronze				
SWP150	Factory installed nailing flange		SWA100	Rainbow Pillow	
SWAP00	Nailing Flange Kit		SW1327	5-1/2-foot Removable Apron	
AR1200	Blower Relocation Kit				





**MADE IN USA**

# Models 9028/9128/9228 Baywood 5.5™

Ariance® Rectangular Air Massage Bath



## Specifications

Model #	Description	Codes/Standards
9028	66" x 36" x 19-3/4" Rectangular HealthTouch™ Air Massage Bath	  
9128	66" x 36" x 19-3/4" Rectangular GentleTouch™ Air Massage Bath	
9228	66" x 36" x 19-3/4" Rectangular DualTherapy™ Air Massage Bath	

Specification	Description	Specification	Description
Material	Acrylic, fiberglass reinforced	Number of Jets	HealthTouch - 52 perimeter, side/back air jets GentleTouch - 48 body/foot micro air jets (8 injectors with 12 side/back jets) DualTherapy - 52 perimeter, side/back air jets and 48 body/foot micro air jets (8 injectors with 12 side/back jets)
Construction	Self-contained, pre-plumbed air massage bath, mounted on a pre-leveled base	Blower	HealthTouch & GentleTouch one variable speed, 120v, 60 Hz, 9.5 Amp, pre-mounted DualTherapy two variable speed, 120v, 60 Hz, 9.5 Amp, pre-mounted
Electrical Requirements	Health and GentleTouch – One 120v, 20 Amp, GFCI dedicated circuit; DualTherapy – Two 120v, 20 Amp, GFCI dedicated circuits	Floor Loading Weight	47 lbs. / sq. ft. (229 kg/m <sup>2</sup> )
Water Capacity	48 gal. (min.) / 58 gal. (max.)	Shipping Weight	165 lbs. - HealthTouch/GentleTouch 180 lbs. - DualTherapy
On/Off Control	Health and GentleTouch – 5-button electronic control pad DualTherapy – 10-button electronic control pad	Warranty	Limited Ten Year

## Technical Information

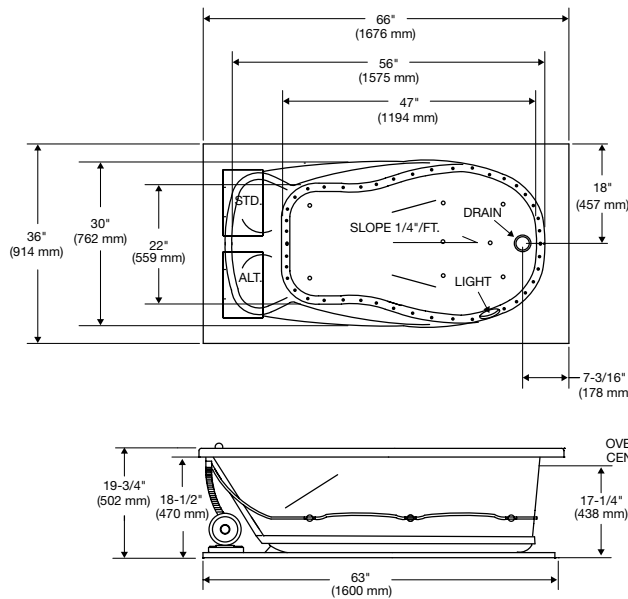

Blower locations are shown for clarity.  
STD - standard blower location  
ALT - alternative blower location.  
Note: Install this product according to the installation guide.

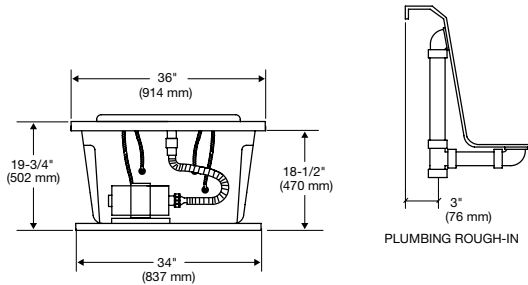

These dimensions are nominal and subject to change without notice.

When tested for compliance to the requirements of ASME A112.19.7M for "Whirlpool Bath Appliances" and ANSI Z124.1.2M "American National Standard for Plastic Bathtub and Shower Units", the tested units are found to comply and are acceptable for listing under IAPMO R & T.

Certified for permanent electrical connection only.



**MADE IN USA**