

# Swash Ecoseat 100

OWNER'S MANUAL



 brondell™  
a better bathroom experience  
S100-EW

## FEATURES

### **Hygienic Dual Wash Wands**

The Swash Ecoseat uses two hygienic wash wands: one for posterior cleansing and the other for feminine cleansing.

### **Sterilizing Water Filter**

The MF filter uses Nano Silver Ceramic technology to sterilize the water to ensure proper product operation and purified wash functions.

### **Non-Electric Operation**

No electricity is required to use the Swash Ecoseat. All Swash functions are operated by the convenient jog dial control and household water pressure.

### **Easy Installation**

No special tools, professional plumber, or electrical outlet required for installation.

### **Ergonomic Design**

The slow-close ergonomic lid and seat are designed to ensure the most comfortable experience.







### **Self-cleaning Hygienic Wands**

Before and after each use, the wash wands self-clean to help stay free of build-up or debris.

### **Air<sup>+</sup> function**

Micro-bubbles introduced into the wash function increase cleansing effectiveness and comfort.

## SAFETY INFORMATION

-  Use this product only for its intended use as directed in this manual.
-  Do not disassemble, repair or modify the product - service should only be performed by a certified Brondell representative.
-  Do not submerge or spray water directly on or into the product.
-  Do not stand or drop heavy objects on this product and do not insert any object into openings or hose.
-  Do not pull or stress the water supply hose.
-  Do not use harsh brushes or abrasive detergents to clean the product, use only mild soap and a soft cloth for cleaning.

## SPECIFICATIONS

Model:	S100-EW
Tap Water Pressure:	14 psi – 98 psi
Seat & Lid:	Slow closing
Product Dimensions:	19" (w) x 19.6" (l) x 6.1" (h)
Product Weight:	5.1 pounds

## PRODUCT DIMENSIONS

### Swash Ecoseat 100 Toilet Fit Diagram

Measurements in millimeters

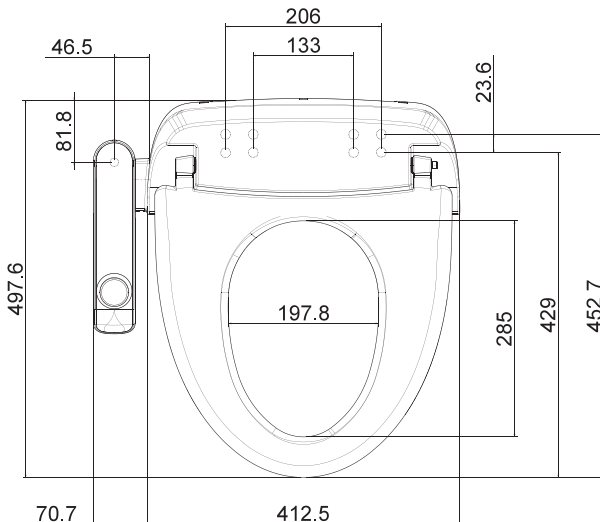

## CONFIGURATION

- |                                  |                                       |
|----------------------------------|---------------------------------------|
| <b>1.</b> Lid                    | <b>4.</b> Pressure regulator          |
| <b>2.</b> Seat                   | <b>5.</b> Bidet hose                  |
| <b>3.</b> Wash wands             | <b>6.</b> MF filter                   |
| <b>a.</b> Front wand (yellow)    | <b>7.</b> T-valve connector           |
| <b>b.</b> Posterior wand (green) | <b>8.</b> Control panel with jog dial |

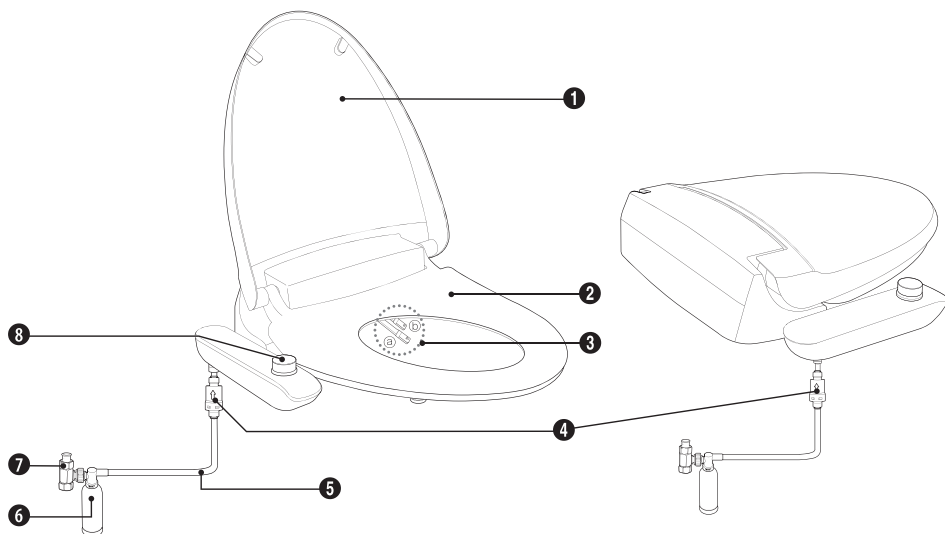

## PARTS

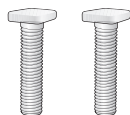

2 ea  
Mounting  
Bolt



Bidet Hose



T-Valve  
Connector  
w/rubber  
washer



Pressure  
Regulator

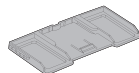

Mounting Plate



2 ea Rubber  
Cone Washer



MF Filter



Filter  
Holder



Filter  
Clip



2 ea  
Metal Bracket



2 ea  
Flat Washer



2 ea  
Barrel Nut

## INSTALLATION

### Before Installation:

#### Check water supply line:

Check the line that connects the toilet tank to the water shut off valve. If it is a rigid pipe, you may need to purchase a flexible hose to replace it before installing the Swash Ecoseat. The length of the hose and the size of the connectors will vary.

#### Tools:

A Phillips head or standard screwdriver may be needed to remove the existing toilet seat and a standard wrench may be needed for tight water supply connections.

### Installation:

*\*Please read these instructions carefully before installing the Swash. Failure to do so could result in flooding, leaking or damage to the product.*

#### 1. Existing Toilet Seat Removal

- a. Lift hinge covers and use a screwdriver to remove the mounting bolts.
- b. Remove the toilet seat.

**Note:** Steps may vary by type of seat.

#### 2. Turn Off Water Supply Valve and Flush Toilet

- a. Turn water valve off completely to stop the flow of water.
- b. Flush toilet and hold down handle to completely empty tank.
- c. Disconnect water supply hose from toilet tank.

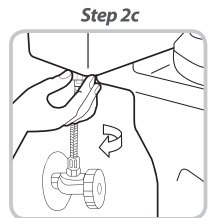

#### Important Notes:

- You may wish to place a container under the tank to catch any excess water.
- Do not continue without completing the above steps. Failure to do so could result in flooding, leaking or damage to the Swash Ecoseat.

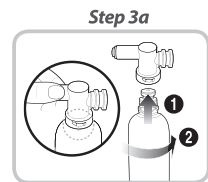

#### 3. Assemble T-Valve, Filter, and Hose Water Connections

- a. Insert MF filter in filter holder by turning counter clockwise to lock into place.
- b. Connect filter holder and MF filter to T-Valve and secure using the provided filter clip.
- c. Connect bidet hose to the filter holder making sure to push all the way in until secure.

**Step 3, Fully Assembled**

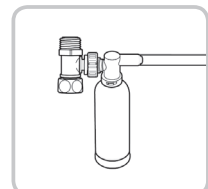

## INSTALLATION

### 4. Connect T-Valve to Water Supply Line & Toilet Tank

**Note:** The T-Valve connects to the fill valve directly under your toilet tank - it does not connect at the wall.

**a.** Install the T-Valve with rubber washer (washer flat side down with lip facing up towards tank connection) to the incoming water connection on the bottom of your toilet tank.

**b.** Connect the water supply line coming from the wall to the T-Valve.

**Important:** Make sure all connections are secured properly. Failure to do so could result in flooding, leaking, or damage to the Swash Ecosat.

### 5. Install Mounting Plate & Attach Swash

**a.** Place mounting plate over mounting holes on toilet, flat side down, black rubber side of mounting plate should be closest to the toilet tank and rubber should be against the ceramic.

**b.** Place metal brackets flat side down in the center of the square opening in the mounting plate and insert mounting bolts through metal brackets and mounting holes. Be sure that the square mounting bolt head is even with sides of metal bracket.

**c.** Slide rubber cone washer, flat washer, and then barrel nut onto mounting bolts under the toilet bowl and tighten to keep mounting plate in place.

**d.** Set the Swash Ecosat flat on the toilet bowl in front of the mounting plate, and slide seat onto plate until it is secure and "clicks" into place.

**e.** If the seat appears too short or too long for the toilet, adjust the mounting plate accordingly. To adjust the mounting plate, loosen barrel nut and slide seat forward or backwards as needed. Once the seat is lined up properly, tighten barrel nuts to hold in place.

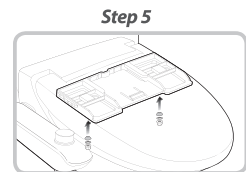

### 6. Connect Pressure Regulator and Bidet Hose to Swash

**a.** Insert pressure regulator into pressure regulator hook-up on bottom side of the control panel and push into place securely.

**b.** Connect the bidet hose to bottom side of pressure regulator and push into place securely.

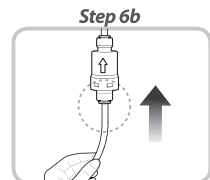
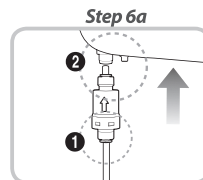

### 7. Turn on Water

**a.** Turn the water valve back on slowly. Ensure connections are not leaking before continuing.

**b.** After 5 minutes, check again and if there are no leaks, the Swash Ecosat is ready to operate.

## UNINSTALLING

### Uninstalling the Swash Ecoseat:

#### 1. To Remove the Swash Ecoseat

- a. Turn off water at supply valve and flush toilet.
- b. Remove pressure regulator from pressure regulator hook-up on underside of control panel.
- c. Disconnect T-Valve and reconnect water supply hose to toilet tank.
- d. Unscrew barrel nuts and remove washers from mounting bolts.
- e. Pull straight up on seat to remove it from toilet.

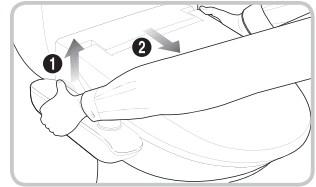

## OPERATION & MAINTENANCE

### How to Use:

#### 1. Front Cleansing

For front, or feminine wash, turn the dial clockwise while seated. The further the dial is turned, the stronger the water pressure.

#### 2. Rear Cleansing

For rear, or posterior wash, simply turn the dial counter-clockwise while seated. The further the dial is turned, the stronger the water pressure.

#### 3. Water Pressure

To change the water pressure, turn the dial more or less in the direction of the wash, either front or rear (posterior). The further the dial is turned, the stronger the water. The less the dial is turned, the lower the pressure will be.

#### 4. Self-Cleaning Nozzles

The nozzles will automatically go through a brief self-clean cycle with each use of the jog dial.

### Maintenance:

**Important! Do not use abrasive chemicals or solvents on the Swash.**

#### 1. Nozzle Cleaning

To clean the nozzles, gently pull them out from inside of the seat manually, and use a soft cloth or toothbrush to clean off any build up. Clean front and rear nozzles in the same manner.

#### 2. Seat Cleaning

Use a soft cloth and mild detergent to clean the Swash seat. For better cleaning, the seat can be removed (see instructions for uninstalling the Swash Ecoseat in previous section).



For questions, contact  
Brondell Customer Service:  
**1-888-542-3355**

## CONTACT INFORMATION

**Brondell, Inc.**

PO Box 470085  
San Francisco, CA 94147-0085

**Phone:** 1-888-542-3355

**Email:** [support@brondell.com](mailto:support@brondell.com)

**Web:** [www.brondell.com](http://www.brondell.com)

## WARRANTY

For detailed warranty information and product registration,  
please go on-line at [www.brondell.com](http://www.brondell.com)

Please retain receipt records for any warranty claims.

Swash<sup>®</sup>  
ecoseat 



MEMO

MEMO

MEMO

