



Submittal Sheet

Part Description:
 4" on 8" PVC WHITE Sewer Saddle Wye
 Solvent Skirt X H

Part Number:
 414848BC

Approvals and Listings maintained by:
Canplas Industries Ltd
 Canada: 1-800-461-5300 USA: 1-888-461-5307

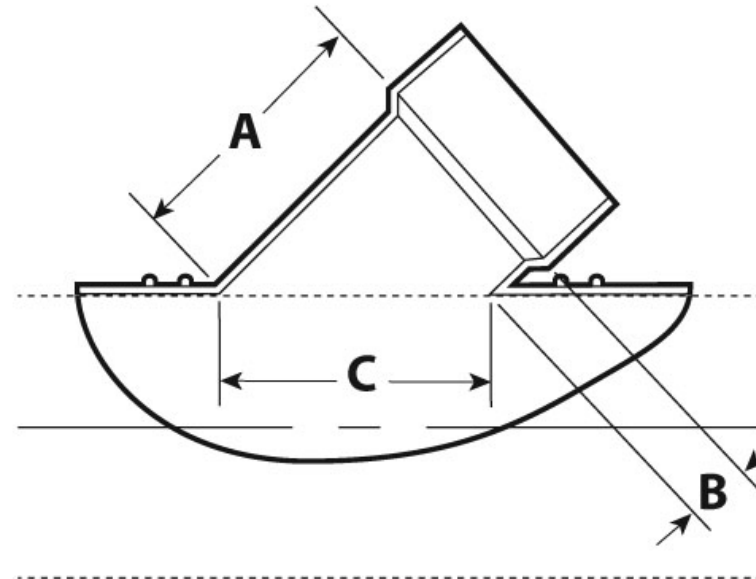

Part #	Part UPC	Colour	Size (inches)	Ctn Qty	Ctn Bar Code	Ctn. Wt (Kgs)	Ctn. Wt (lbs)	Skid Cubic (m)	Skid Cubic (ft)	Ctns/Skid
414848BC	662671412409	WHITE	4X8	5	20662671412403	4.47	9.83	1.79	63.37	24

Dimensions (inches)

A	B	C
4.89	5.60	5.60