

Pro Max

FM Remote Control System

User Manual

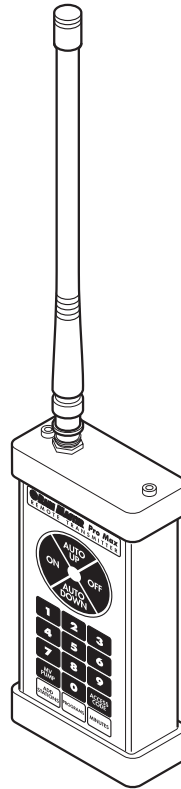

Models:
PROMAX
PROMAX-UA



Document No. 500055 Rev. E

Table of Contents

1.0 Introduction.....	1
1.1 Pro Max Features.....	2
1.2 Ranges and Method of Transmission	3
1.3 Licensing Information	4
2.0 Model Pro Max Remote Control System (Rain Master Only).....	6
2.1 Using the Receiver with a Rain Master Controller	7
2.1.1 Connecting the Receiver to a Rain Master Controller	7
2.1.2 Disconnecting the Receiver from a Rain Master Controller	8
2.2 Permanent Mount Pro Max Receiver	8
2.3 Keystroke Operation.....	11
2.3.1 Evolution DX2 Keystroke Operations	14
3.0 Model Pro Max-UA Remote Control System (Universal)	15
3.1 Using the Pro Max-UA Universal Adapter with a Non Rain Master Controller	16
3.2 Installing the Pro Max-UA System	16
3.3 Temporary Connector Installation.....	19
3.4 Disconnecting the Pro Max-UA from a Non-Rain Master Controller	19
3.5 Non-Rain Master Controllers Lacking 24 Volts AC.....	19
3.6 Disconnecting the Pro Max-UA from a Non-Rain Master Controller	20
3.7 Non-Rain Master Controllers Lacking 24 Volts AC.....	20
3.8 Permanent Wire Connections	20
3.9 Keystroke Operation.....	21
4.0 Detailed Operation.....	22
4.1 Remote Operation.....	22
4.2 Stations On and Off	22
4.3 Auto Up and Auto down Keys	23
4.4 On and Off Keys.....	23
4.5 Master Valve/Pump Key	23
4.6 Controller Access Code.....	24
4.7 Add Stations	25
4.7.1 Add Stations – On Key	25
4.7.2 Add Stations – Auto Up and Auto down Keys	25
4.7.3 Add Stations - Off Key	25
4.8 Program Function	26
4.8.1 Program – Off Key	26
4.8.2 Program – Auto up Key	26
4.8.3 Program - Sensor Switches	26
4.9 Minutes Function.....	27
4.10 Beeper Operation.....	27
4.10.1 Power on Beeper Operation	27
4.10.2 Universal Adapter Over-Current Detection Beeper	28
4.11 Transmitter Battery Replacement.....	28

5.0 Checking Out Electrical Problems.....30

5.1 Field Wiring Shorts, the Receiver, and Rain Master Controllers..... 30

5.2 Field Wiring Shorts, the Receiver, and Non Rain Master Controllers..... 30

5.3 A Note about Solenoids..... 30

6.0 Troubleshooting31

7.0 Pro Max Specifications.....33

7.1 Pro Max Transmitter 33

7.2 Pro Max Receiver..... 33

7.3 Pro Max Universal Adapter..... 33

7.4 Pro Max Carrying Case 33

8.0 Pro Max Series Parts List34

Rain Master Limited Warranty35

Table of Figures

Figure 1: Pro Max FM Remote Control System..... 1
Figure 2: Complete Pro Max System..... 6
Figure 3: Pro Max Receiver to Rain Master Controller..... 8
Figure 4: Permanent Mount Pro Max Receiver 9
Figure 5: Pro Max Transmitter (PM-XMTR) 10
Figure 6: Complete Pro Max-UA System..... 15
Figure 7: Relay (such as Rain Master RLY1)..... 17
Figure 8: Pro Max-UA Installation to a Non-Rain Master Controller..... 19
Figure 9: Non-Rain Master Controller 24 Volts AC 20
Figure 10: Pro Max-UA Permanent Connection 21
Figure 11: Battery Replacement 28

Notice:

Information furnished by Rain Master Irrigation Systems Inc. is believed to be accurate and reliable. However, Rain Master shall not be liable for errors contained herein or for incidental or consequential damages in connection with the furnishing, performance or use of this material.

The information contained in this document is subject to change without notice.

Pro Max

Congratulations... you have chosen one of the ultimate weapons to use in keeping maintenance costs down and satisfaction high – the Rain Master **Pro Max** Remote Control System. Rain Master engineer's take great pride in all their work, but they are especially proud of **Pro Max**. You'll find it packed with features you've been looking for and it's extremely easy for everyone to use. **Pro Max** has been designed to give you years of dependable service.

To take full advantage of all the ways **Pro Max** can help you do your job more efficiently and economically, please take a few minutes and read your User Manual. It won't be long before your best friend in the field is **Pro Max**.



Figure 1: Pro Max FM Remote Control System

1.0 Introduction

The Pro Max Remote Control System is designed to save valuable time and energy, which would have been spent walking back and forth between the controller and the irrigation field zone

location. It makes light work of system checkouts and service work, providing field personnel with complete control over the irrigation controller.

Controllers may be operated remotely from watering zone sites allowing immediate evaluation of the irrigation configuration and performance. Using the hand-held battery operated Pro Max Transmitter from a remote zone location; the operator may turn ON a single station or any number of stations with the push of a few simple keys.

An access code feature allows independent control of multiple Pro Max receivers permanently installed in up to 999 controllers. In addition to the maintenance features, the Pro Max system provides specialized irrigation functions, which are described in Section 1.1.

The Pro Max remote control system is composed of two model numbers:

Model No.	Description
Pro Max	Used with Rain Master only controllers. (See Section 2.0)
Pro Max-UA	Used with any manufacturers' 24-volt AC controller. (See Section 3.0)

1.1 Pro Max Features

Simplicity

- The industries easiest remote to use.
- Fits in shirt or pants pocket or can be attached using the convenient belt clip.
- Large dedicated feature keys allow most functions to be performed with a single key operation.
- Auto-up and auto-down station operation.

Flexibility

- Can be used with any manufacturers' 24-volt AC controller (Model Pro Max-UA).
- Independent control of the master valve and/or pump.
- Single or multi-station capabilities for testing system hydraulics.
- Timed station operation selectable from 1 to 60 minutes.
- Control up to 999 individual Pro Max receivers from a single Pro Max transmitter.
- Ability to turn a program ON or OFF (when used with RME Sentar, RME Hawk, RME Eagle, or Evolution DX2 controllers).
- Small and compact Pro Max receiver design facilitates permanent internal controller mount.
- Compatibility with Rain Master RT5/RRAD remote.

Intelligence

- Detects and provides an audible alert against field wiring short circuits (Model Pro Max-UA).
- No more tripped circuit breakers or blown fuses during installation checkout.
- Receiver has built-in safety default to automatically turn station OFF after 60 minutes.
- Audible Pro Max transmitter and Pro Max receiver tones verify proper Pro Max remote control operations at all times.
- High tech power saver circuitry means no more battery recharging required (no down time).
- Transmitter has a single replacement lithium battery that can be purchased locally and field replaced. The battery will last an entire season, under normal conditions.
- Audible low battery alert.
- No fuses required.

Durability

- Tough, rugged all metal construction with shock absorbing rubber bumpers.
- Hard cover case for carefree transportation.

Reliability

- Utilizes three mechanisms to insure reliable, interference-free communications.
 - Digital filters
 - Factory set coding
 - VHF FM communications

1.2 Ranges and Method of Transmission

It is not possible to exactly predict the distance over which the Pro Max system will perform. Several factors may affect the distance and reliability of any radio transmission:

- Frequency used
- Terrain
- Building Structures
- On channel interference
- Antenna types
- Transmission Power
- Antenna placement
- Weather conditions
- Atmospheric disturbances
- Mode of operation (AM, FM, etc.)

Your Pro Max system has been designed to operate at distances up to one mile. Under ideal open field conditions, it can readily operate up to 5 miles.

When attempting to use Pro Max over extended distances, it is important to ensure that the receiving antenna is properly located. If possible, avoid Pro Max receiver antenna locations,

which are indoors, especially basements, or structures, which are concrete and steel. It may be possible to remotely locate an external antenna whenever poor Pro Max receiver locations exist. Call Rain Master Technical support for assistance, telephone (805) 527-4498. Moving the Pro Max transmitter to a more favorable location or usage of optional high gain antennas on both the Pro Max transmitter and Pro Max receiver may improve operations.

The Pro Max system utilizes VHF/FM communications and the Pro Max receiver/Pro Max transmitter pair is factory encoded to insure that other services including other Rain Master remotes do not interfere or false trigger the Pro Max receiver. Digital filtering further enhances operation in interference prone environments. FM transmission is employed for its inherent quality and immunity to atmospheric, static, and electrical interference which are commonly found in AM types of equipment such as citizen's band radio, garage door openers, etc. Usage of FM transmissions also insures that the stronger signal prevails (capture ratio), meaning that all received signals, which are weaker than the Pro Max transmission, are completely overridden.

Note: Antennas are not just a piece of wire; they are cut for a precise frequency of operation in order to ensure optimal performance. When using antennas with the Pro Max system, only utilize Rain Master specified parts, which are available through your authorized Rain Master distributor.

1.3 Licensing Information

Your Rain Master Pro Max radio operates on FM radio communication frequencies and is subject to the rules and regulations of the local communications governing agencies. These agencies may require that all operators using private land mobile or general mobile radio frequencies obtain a radio license before operating their equipment. The operator receives a license for use of the radio equipment under a specific eligibility and ON a particular frequency or set of frequencies. To determine eligibility for use of private land mobile service frequencies, contact your local communications governing agency. This agency can supply information required to properly obtain and complete the license application form.

For U.S. License Applications, contact:

FCC Forms Distribution Center

1 (800) 418-3676

Request form 600 and all schedules and instructions.

For license questions call the FCC at 1 (888) 225-5322.

The following are addresses of communications agencies in North America:

United States

Federal Communications Commission
1270 Fairfield Road
Gettysburg, PA 17325-7245
1-800-322-1117

Canada

Department of Communications
1241 Clyde Avenue
Ottawa, Ontario
K2C 143

Mexico

Secretaria De Comunicaciones
Y Transportes
Direccion General de Politicas Y Normas de Comunicaciones
Av. Eugenia No. 197-5o. Piso
Mexico, D.F. 06700

2.0 Model Pro Max Remote Control System (Rain Master Only)

The Pro Max receiver is designed to connect directly to any Rain Master controller by plugging the 9-pin connector from the Pro Max receiver into the front panel remote control jack found ON Rain Master controllers.

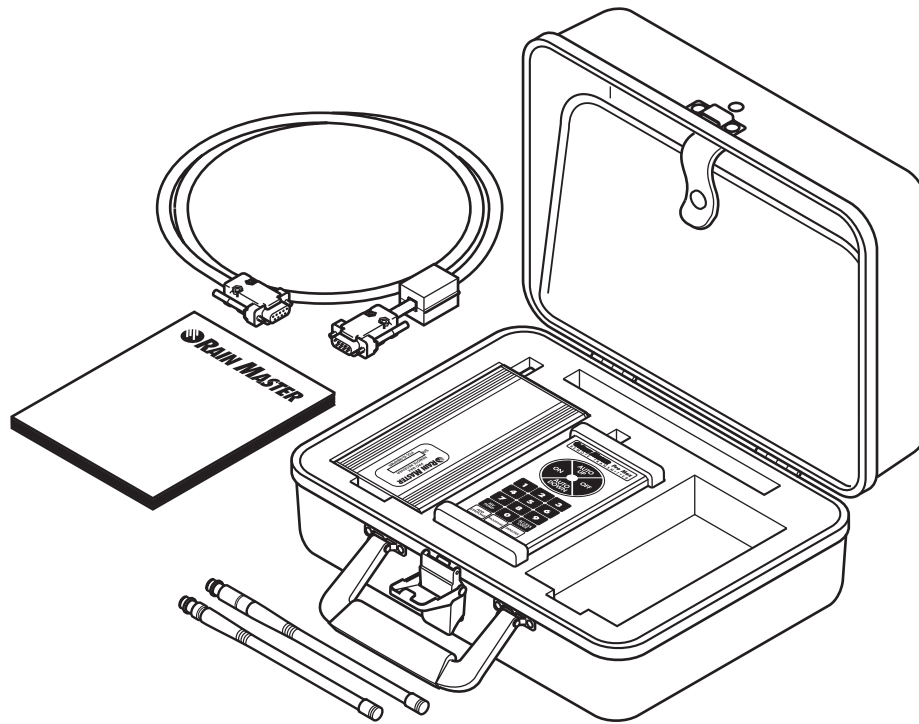

Figure 2: Complete Pro Max System

Pro Max Parts List

Part No.	Ref.	Description
PM-XMTR	1	Pro Max Remote radio transmitter
PM-RCVR	2	Pro Max Remote receiver
PM-SER99	3	36" remote cable
500055	4	Pro Max User's manual
PM-CASE	5	Pro Max carrying case
PM-ANT-XMTR	6	Antenna, BNC
PM-ANT-RCVR	7	Antenna, hinged, BNC

2.1 Using the Receiver with a Rain Master Controller

One of the unique and patented features of Rain Master Controllers is the built-in capability for remote control. Making the connections between the hand held remote transmitter and the Pro Max receiver, which is attached to the controller, takes just a few seconds.

2.1.1 Connecting the Receiver to a Rain Master Controller

Connecting the Pro Max receiver to the controller is a very simple operation. The following procedure steps are all that is required. Please refer to Figure 3: Pro Max Receiver to Rain Master Controller.

- Step 1** Make sure the controller is in the Automatic mode press the controllers' QUIT key.
- Step 2** Make sure the controller's Rain Switch, if so equipped, is in the automatic watering position.
- Step 3** Place the Pro Max receiver on top of the controller with the antenna pointing straight up. Do not allow the antenna to touch any metal objects or wire.
- Step 4** Connect the female end of the PM-SER99 cable to the Pro Max receiver and secure with lock screws. Hands tighten only. Connect the other end of the cable to the remote control receptacle on the front panel of the controller (it is keyed to fit only in one way).

The controller's display will either go blank or indicate that the remote is active. The Pro Max receiver will beep to indicate that it is ready for use.

Note: NEVER operate the Pro Max transmitter without the CORRECT antenna properly installed.

Upon Receiver Connection	
Beep Response	Description
1 Beep (1/2 sec)	Ready
2 Beeps	Multi-Pro Max receiver mode: <ul style="list-style-type: none"> Requires corresponding access code to enable Pro Max receiver operation.
3 Beeps	Failed internal diagnostic tests. Contact Rain Master.

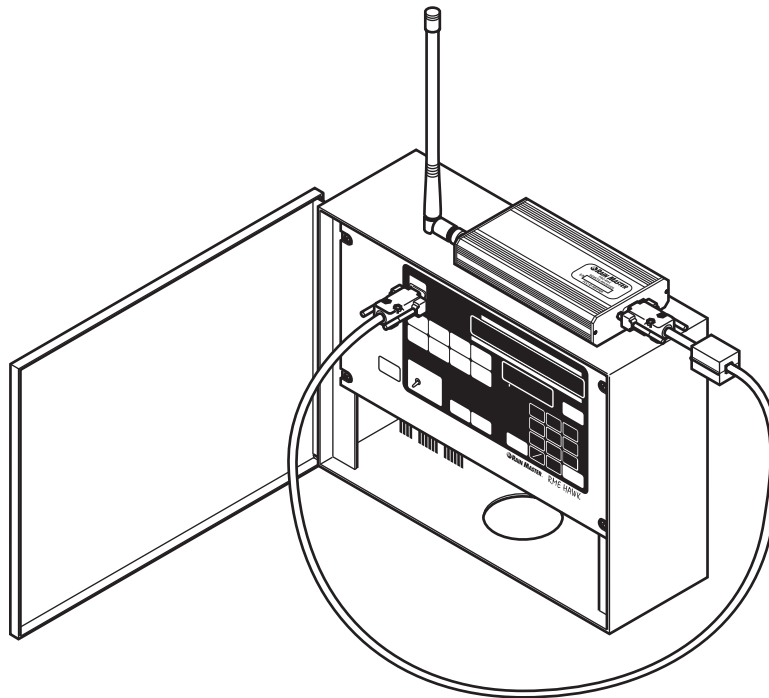

Figure 3: Pro Max Receiver to Rain Master Controller

2.1.2 Disconnecting the Receiver from a Rain Master Controller

To disconnect the Pro Max receiver, follow the procedure below.

- Step 1** Disconnect the Pro Max receiver's plug from the controller's front panel by grasping the plug housing, not the cable, and pulling straight out. The controller display should now return to the automatic screen display.

2.2 Permanent Mount Pro Max Receiver

Pro Max Receivers may be permanently installed into any Rain Master controller.

Two items are required for permanent controller installation:

1. Part No. JACK-IRC

- Factory installed permanent interface.
- Factory programmed Pro Max receiver with a programmed access code (1-999). Access codes are required whenever one Pro Max transmitter controls multiple Pro Max Pro Max receivers.

2. Part No. PMRKIT

- Permanently mounted Pro Max receiver
- Antenna Pro Max-ANT
- All interconnecting cables and hardware

Note: Operation of a permanent mount Pro Max receiver requires usage of the ACCESS CODE feature key. Refer to section 4.6.

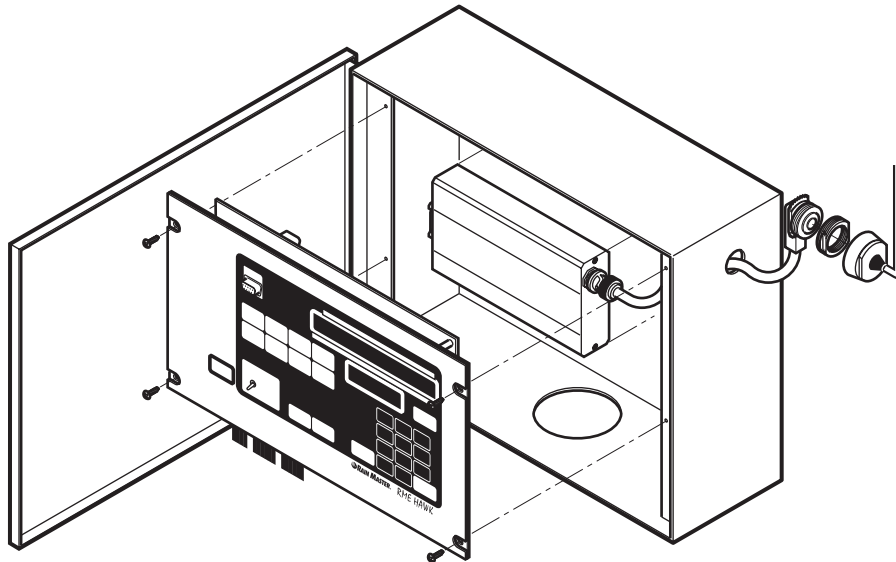

Figure 4: Permanent Mount Pro Max Receiver

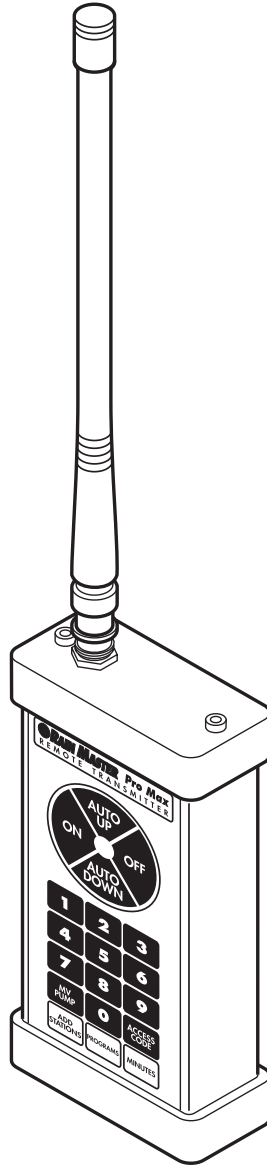

















Figure 5: Pro Max Transmitter (PM-XMTR)

2.3 Keystroke Operation

The Pro Max keyboard layout is shown in Figure 5.

Basic Operation	
Function	Keystrokes
Increment to next Station	
Decrement to next Station	
Turn On Station 12	  
Turn Off Station 12	
Turn On Master Valve/Pump	 
Turn Off Master Valve/Pump	 











Note: Any prior operating station will turn OFF when an Auto-Up, Auto-Down, Station On, Station Off key is pressed.

Timed Station Operation (Minutes) *	
Function	Keystrokes
Turn On Station 1 for 5 minutes	   
Increments To Next Station and Re-start Timer	
Decrement To Next Station and Re-start Timer	

Multiple Stations On (Add Stations)	
Function	Keystrokes
Turn On Multiple Stations 1, 2, 6,	
Turn Station 6 OFF (Station 1, 2 remain)	
Turn All Stations OFF	
Turn All Stations OFF and Increment the stations selected From Last Station	

* When this function is used with the Rain Master RME Sentar, RME Hawk, or Evolution DX2 controllers, the controller will automatically turn ON the appropriate Master Valve or Pump.















Program Operation (Program) **	
Function	Keystrokes
Turn Program 5 On	
Increment to Next Station in Program	
Turn Program 5 Off	

Using Multiple Receivers (Access Code)	
Function	Keystrokes
Enable Pro Max Receiver #15. Controller now accepts all remote keys.	   
Disable Pro Max Receiver #15	   
Disable All Pro Max Receivers	 

** This function only works with the following Rain Master controllers: RME Sentar, Hawk, Eagle, Evolution DX2 controllers. Only one program can be operated at a time.

2.3.1 Evolution DX2 Keystroke Operations

The following operations are only available when using the Pro Max Remote Control System with the Rain Master Evolution DX2 Controller:

Evolution DX2 Master Valve			
Function	Keystrokes		
Turn On Master Valve One			
Turn ON Master Valve Two			
Turn On Normally Open Master Valve (Closes the normally open valve)			
Turn Off Normally Open Master Valve (Valve returns to normally open state)			
Turn On Pump			

3.0 Model Pro Max-UA Remote Control System (Universal)

The Pro Max-UA Universal Adapter Model offers the capability to connect to virtually any controller, regardless of manufacturer. This system consists of:

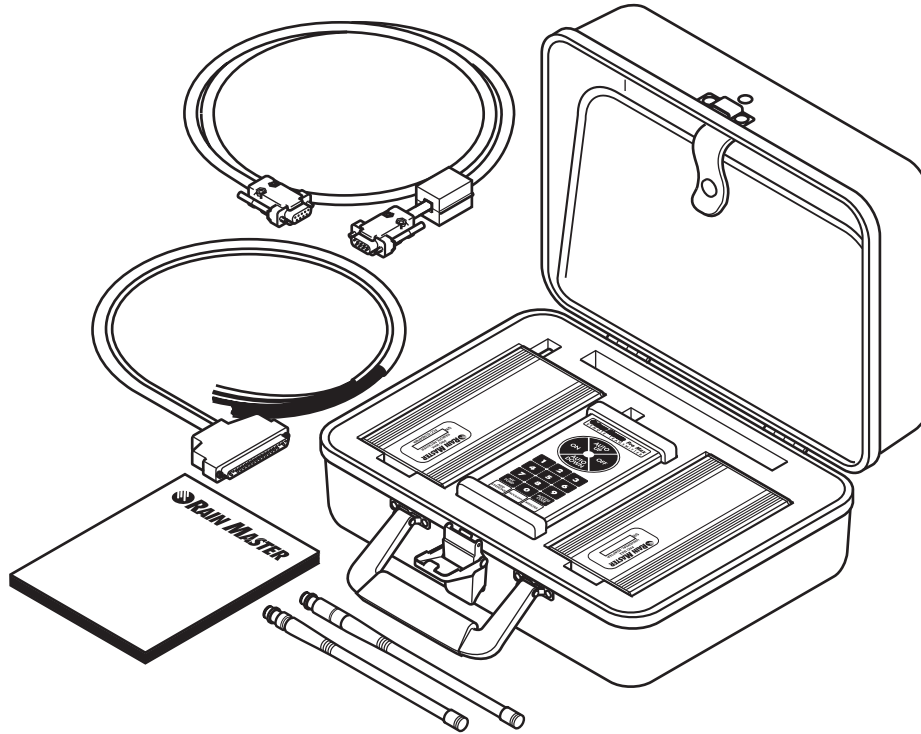

Figure 6: Complete Pro Max-UA System

Pro Max-UA Parts List

Part No.	Ref.	Description
PM-XMTR	1	Pro Max Remote radio transmitter
PM-RCVR	2	Pro Max Remote receiver
PM-SER99	3	36" remote cable
PM-UADAPT	4	Universal adapter
32 PC	5	30" permanent connector
500055	6	Pro Max User Manual
PM-CASE	7	Pro Max carrying case
PM-ANT-XMTR	8	Antenna, BNC
PM-ANT-RCVR	9	Antenna, hinged, BNC

The Universal Adapter is equipped with a 35-conductor connection cable RMIS Part Number 32PC, which must be physically wired to each station of the generic controller.

Note: If you have purchased model Pro Max-UA and you need to connect to a Rain Master controller, the Universal Adapter box (PM-UDAPT) is not required. Refer to section 2.0 for installation and operation.

In cases where the controller does not provide the required 24 Volts AC, a step-down transformer is employed to convert standard 117 Volts AC or 220 Volts AC to 24 Volts AC.

3.1 Using the Pro Max-UA Universal Adapter with a Non Rain Master Controller

The controller serves only two purposes when using the Universal Adapter.

First, it provides 24 Volts AC for the Pro Max receiver. Never allow more than the “normal” 24 Volts AC (up to 28 Volts AC maximum) to enter the Pro Max receiver through the wires designated for 24 Volts AC. If the controller runs ON a voltage other than 24 Volts AC, use a step-down transformer to convert the voltage to 24 Volts AC for input to the Pro Max receiver. Transformers that convert higher voltages to 24 Volts AC are available from Rain Master.

Secondly, the controller serves as a point of connection for the field wires and the Pro Max receiver's output. Usually the point of connection is the terminal strip or a quick disconnect within the controller or pedestal. Rain Master offers several types of connector cables for wiring to the controller. The RMIS Part Number 32PC or RMIS Part Number 24PC Permanent Connector Cable, which is intended to be permanently connected to the controller. The other is the RMIS Part Number 32TC Temporary Connector using alligator clips.

3.2 Installing the Pro Max-UA System

To install a Permanent Connector, follow the instructions below. Prior to installation, please observe the following precautions:

CAREFUL	CAUTION	DANGER
WARNING:	STOP – PLEASE READ ALL INSTRUCTIONS AND THE FOLLOWING WARNING MESSAGES BEFORE OPERATING THIS EQUIPMENT.	

Always use with the approved Rain Master cable connector assemblies (RMIS Part Number 24PC, RMIS Part Number 32PC, RMIS Part Number 32TC, RMIS Part Number 32EX) Use of any other connector will void the warranty and may damage the Pro Max remote control system.

NEVER allow more than the “normal” 24 Volts AC to enter the Universal Adapter on any of its wires. If there is any question about a connection voltage, check the voltages with a voltmeter.

NEVER operate the Pro Max transmitter without the CORRECT antenna properly installed.

NEVER connect the Universal Adapter to more than one controller at a time.

Procedure (Refer to Figure 7)

- Step 1** Remove power from the controller.
- Step 2** Connect a single wire to each station (up to 32) of the RMIS Part Number 32PC wiring harness at the controller's terminal strip. The field wiring should remain connected and in place. Simply add the RMIS Part Number 32PC wiring to it. Make sure to follow the station color code-wiring list illustrated ON the back cover of this manual.

Note: The chart defines the connections for the following cables: RMIS Part Number 32PC (supplied with Pro Max-UA), RMIS Part Number 24PC, 12PC, and RMIS Part Number 32TC.

Make sure that any unused station wires on the PC cables are insulated and will not short to any metal object.

If there is a Master Valve and/or Pump in the system, make sure you understand how they are controlled before hooking up the Master Valve and/or Pump wire of the Permanent Connector. If there is any doubt - find out before connecting it to a voltage above the "normal" 24Volts AC will damage the Pro Max Pro Max receiver unit.

If the Controller Supplies 24 Volts AC to activate the Master Valve/Pump, then connect the Master Valve/Pump wire of the Permanent Connector to the controller's Master Valve/Pump terminal.

If the Controller acts as a switch to activate the Master Valve/Pump Finding two terminals in the controller associated with the Master Valve/Pump usually, but not always, indicates that a relay will be required. The relay is wired such that its coil terminals are activated by the Master Valve/Pump and COMMON of the PC and its switch contacts are in parallel with the controller's two terminals, see Figure 4 below.

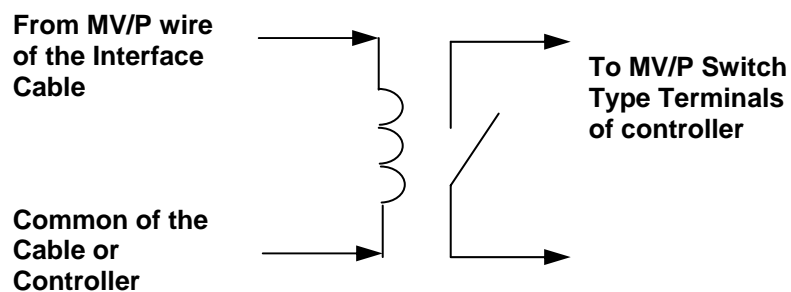

Figure 7: Relay (such as Rain Master RLY1)

Step 3 Connect the wire for the PC Cable COMMON to the COMMON terminal of the controller.

Step 4 Important! If 24 Volts AC is not available from the controller's terminal strip, see Section 3.5 and skip to Step 6 below.

Step 5 Connect the wire from the PC cables 24 Volts AC to the 24 Volts AC terminal of the controller. Note that the PC cable has only one wire for 24 Volts AC despite the controller having two 24 Volts AC terminals. This is because the controller takes one of its 24 Volts AC terminals and connects it to the COMMON terminal and you have already attached the PC cables COMMON wire to the controller's COMMON terminal.

You must find which 24 Volts AC terminal on the controller is NOT electrically the same as the controller's COMMON terminal and connect the PC's 24 Volt AC wire to it.

Using a voltmeter, power up the controller and set the voltmeter on a 30 Volts or higher AC scale. Place one of the voltmeter leads ON the controller's COMMON terminal and use the other lead of the meter to read each of the 24 Volt AC terminals. Connect the PC cables 24 Volt AC wire to whichever terminal gives a reading of 24 Volt AC on the meter.

If the controller does not have any terminals marked 24 Volts AC then leave one of the voltmeter leads ON the controller's COMMON and try the other lead of the meter to measure the low voltage wires ON the secondary of the controller's transformer. Connect the PC cables 24 Volts AC wire to whichever terminal provides a reading of 24 Volts AC ON the meter.

Step 6 Place the Rain switch in the OFF or Rain position.

Step 7 Connect the 9-pin female end of the PM-SER99 cable to the Pro Max receiver and the male end to the universal adapter. Hands tighten the screw locks.

Step 8 Align the large connector of the RMIS Part Number 32PC cable with the connector ON the universal adapter and plug them together.

Step 9 Reconnect power to the controller. Refer to the following table:

Upon Receiver Connection	
Beep Response	Description
1 Beep (1/2 sec)	Ready for use.
2 Beeps	Multi-Pro Max receiver mode: <ul style="list-style-type: none"> • Requires corresponding access code to enable Pro Max receiver operation.
3 Beeps	Failed internal diagnostic tests. Contact Rain Master.
No Beeps	Check the 24 Volts AC and COMMON connections.

3.3 Temporary Connector Installation

The RMIS Part Number 32TC Temporary Cable is wired in the exact same fashion as the Permanent Cable Connector described above except that it uses alligator clips for connection to the terminal strip within the controller so that it may be easily installed and removed. Follow the connection instructions for the permanent connector; be very careful that the alligator clips are secure and not “shorting” to any metal or each other.

3.4 Disconnecting the Pro Max-UA from a Non-Rain Master Controller

To disconnect the universal adaptor, use the following procedure:

- Step 1** Disconnect the large 37 pin connector plug from the universal adaptor by grasping the plug's body, not by the cable, and pull straight out.

3.5 Non-Rain Master Controllers Lacking 24 Volts AC

24 Volts AC is required to power the Universal Adapter. If 24 Volts AC is not available from the controller, use a step-down transformer to convert from the line voltage (usually 117 or 240 Volts AC) to 24 Volts AC and run the 24 Volts AC wire into the PC cable to the two wires designated for 24 Volts AC and COMMON. There is no need to worry about the polarity of these two connections. Additionally, connect the PC cables COMMON wire to the controller's COMMON terminal. Do not connect the PC cables 24 Volts AC wire to the controller.

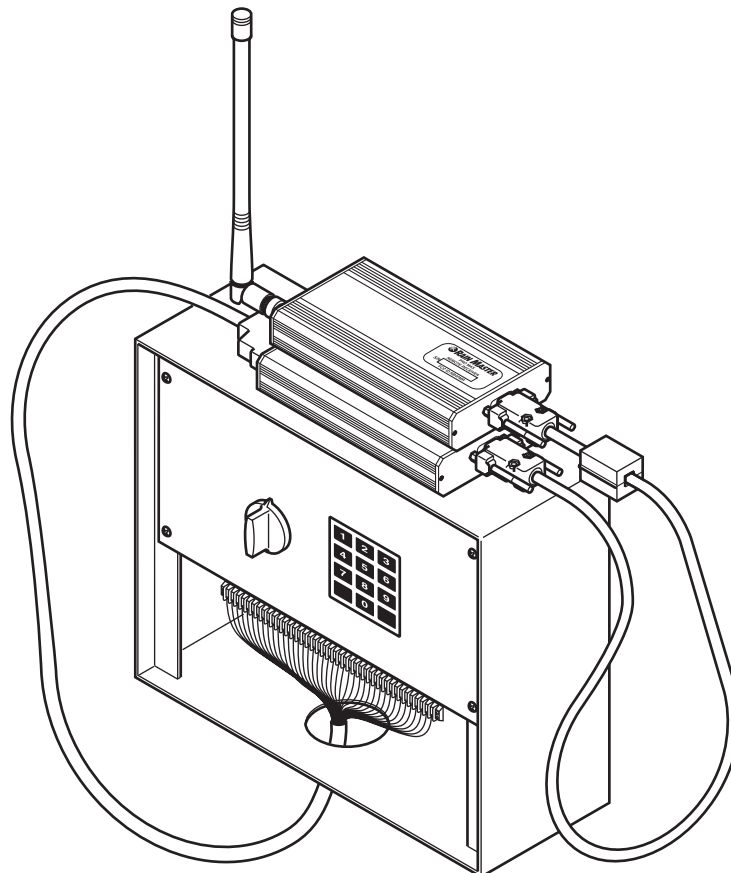

Figure 8: Pro Max-UA Installation to a Non-Rain Master Controller

3.6 Disconnecting the Pro Max-UA from a Non-Rain Master Controller

To disconnect the universal adaptor, use the following procedure:

- Step 1** Disconnect the large 37 pin connector plug from the universal adaptor by grasping the plug's body, not by the cable, and pull straight out.

3.7 Non-Rain Master Controllers Lacking 24 Volts AC

24 Volts AC is required to power the Universal Adapter. If 24 Volts AC is not available from the controller, use a step-down transformer to convert from the line voltage (usually 117 or 240 Volts AC) to 24 Volts AC and run the 24 Volts AC wire into the PC cable to the two wires designated for 24 Volts AC and COMMON. There is no need to worry about the polarity of these two connections. Additionally, connect the PC cables COMMON wire to the controller's COMMON terminal. Do not connect the PC cables 24 Volts AC wire to the controller.

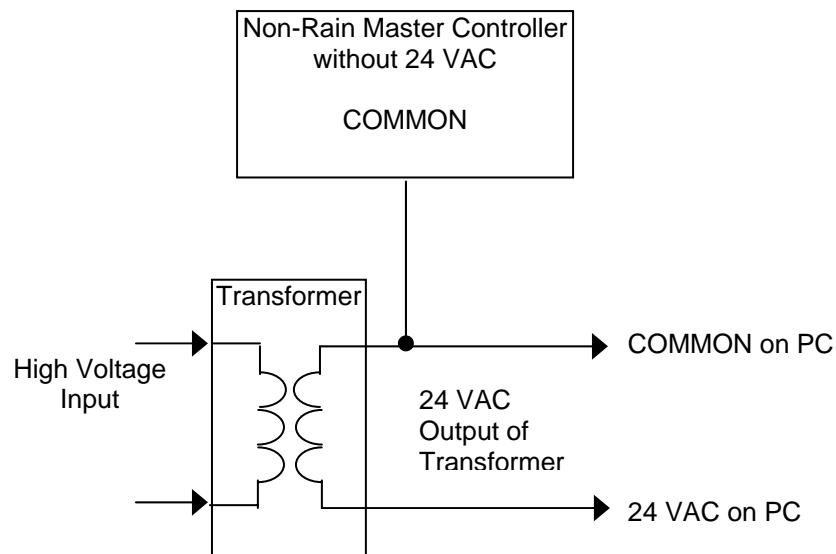

Figure 9: Non-Rain Master Controller 24 Volts AC

3.8 Permanent Wire Connections

A permanent mount connector can be installed on any controller so that the Pro Max-UA can be easily installed and disconnected without having to deal with wiring connections. Three parts are required (see Figure 9).

1. RMIS Part Number 32PC (or appropriate size cable)
2. RMIS Part Number CMAD (chassis mount adaptor)
3. RMIS Part Number 32EX (48" extension cable)

3.9 Keystroke Operation

Refer to section 2.3.

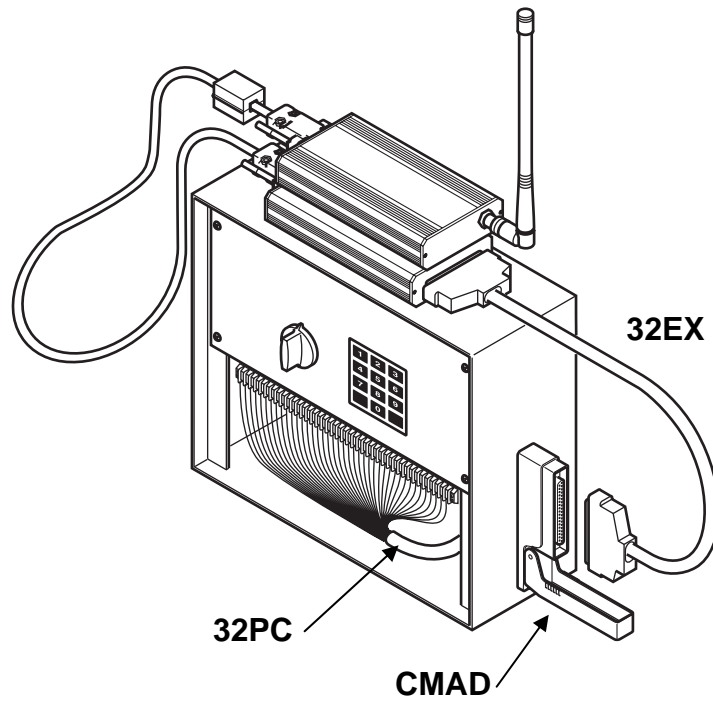

Figure 10: Pro Max-UA Permanent Connection

4.0 Detailed Operation

4.1 Remote Operation

When the remote Pro Max receiver is connected to a Rain Master controller, all running programs are aborted, any stations and/or any master valves or pumps that are ON will be turned OFF. During the time the remote is connected, the controller will display the “Remote” message. Some controllers will blank the display or display additional information.

When the remote is disconnected, all stations and any Master Valve or Pumps, which are ON, will be turned OFF. The only exception are programs, their operation remains unaffected upon disconnection of the Pro Max receiver. (See section 4.8)

The Pro Max Series remote commands are an extended set of the older Rain Master RT5/RR/RRAD remote control. The user interface for Pro Max remains identical when performing like functions. The Pro Max remote control system however has several newer capabilities and features, which will be delimited in subsequent sections.

In general, turning a station ON or OFF is independent of the master valve operation. That is, turning a station ON will not affect the state of the master valve and vice versa. The exception to this is timed station operation. Turning a station ON for a certain period of time will automatically select the proper master valve and/or pump as required in order to perform irrigation.

With the older Rain Master RT5 series remote system, only one station was allowed to be on at a time. All remote key operations resulted in the previous station being turned off, prior to the next station turning on. This is also true with Pro Max with one exception. The ADD STATIONS feature has been incorporated so that multiple stations may be turned on simultaneously.

Each time a key is depressed at the Pro Max transmitter, a confirmation audio beep is generated. Upon receipt of the command, the Pro Max receiver also generates a confirmation beep. Consequently, basic Pro Max system performance can be verified by hitting a key at the Pro Max transmitter while listening for the corresponding beep at the Pro Max receiver.

4.2 Stations On and Off

When one of the Pro Max transmitter's keys is pressed, a signal is transmitted and an audible tone is generated to acknowledge that the signal has been transmitted.

All stations, except the Master Valve/Pump, are turned on by pressing the number of the station followed by the ON key. To turn off a station, simply press the OFF key. To turn the station on again, press the ON key. There is no need to press the station's number until a new station is desired.

Example: To turn Station 12 on, then off, and then on again.



Example: To go to Station 3, there is no need to turn 12 off.



The controller automatically turned Station 12 off prior to turning Station 3 on.

4.3 Auto Up and Auto down Keys

For convenience and the rapid checkout of a system, pressing Auto Up will turn off the current station and turn on the next sequential station number. There is no need to enter the station number.

Note: If the last station in a Rain Master controller is reached and Auto-Up is pressed, wrap-around occurs (station 1 turns on). In a Pro Max-UA model, wrap-around occurs after station 32 is reached.

Similarly, pressing Auto Down will turn off the current station and turn on the next lower station number.

Once you find the station you want, you may turn it on and off simply by pressing the ON and OFF keys. There is no need to know the station number.

Example: You come to a job site and you know it has a problem but you don't know which station has the problem. Simply hook up the Pro Max receiver, go out to the field and press Auto Up until you find the problem, then use the ON and OFF keys.

4.4 On and Off Keys

When the ON key is pressed, the station previously entered will be turned on, any other station that was on will be turned off.

The previous station may have been entered explicitly by the digit keys or implicitly by using the AUTO UP or AUTO DOWN keys. When the remote is first connected and the ON key is pressed, nothing happens because the previous station is undefined.

When OFF is pressed, any station that was on will be turned off.

4.5 Master Valve/Pump Key

The Master Valve/Pump may be turned on or off at anytime. Its on/off state is unaffected, as other valves are turned on or off. Therefore, checkout of an electrical problem on any valve may be accomplished without actually watering, simply by turning the Master Valve/Pump off. This assumes the system has a Master Valve and/or Pump.

Example: To turn the Master Valve/Pump on,



To turn it off,



Refer to section 2.3 for additional Master Valve and Pump operations, which are applicable to the Evolution DX2 controller.

4.6 Controller Access Code

The Access Code key is used to enable/disable the remote control Pro Max receiver. This allows the user to have numerous Pro Max receivers permanently attached to Rain Master Controllers or (any manufacturer's controllers) at different geographic sites each with their own Controller Access Code. One transmitter can be used to address them individually.

Access codes are factory-defined numbers ranging from 1 - 999. These codes are factory programmable and should be requested at the time the unit is ordered. You must know the Controller Access Code of the individual Pro Max receivers. The access code number of any Pro Max receiver is listed within the Pro Max receiver serial number on the Pro Max receiver label.

Example: S/N RX031001-007-001

The access code appears as the third set of 3 digits (last digits) following the second dash; in this case, the access code is 001.

Example: To enable Pro Max receiver number 1,



Receiver number 1 is now enabled and responds to all commands.

Example: To disable Pro Max receiver number 1,



Pro Max receiver number 1 is now disabled and will not respond to any commands. The attached Rain Master controller returns to its automatic mode and operates as if the remote has been disconnected.

Note 1: It is possible to have more than one Pro Max receiver enabled simultaneously (broadcast mode). In this mode, all enabled Pro Max receivers would respond to commands from the Pro Max transmitter.

Note 2: It is also possible to disable all enabled Pro Max receivers without using their Controller Access Code by pressing:



Note 3: the Pro Max receivers will automatically time-out (after 8 hours) if a Pro Max receiver is left enabled and no remote activity has occurred. The controller shall then resume its normal operation (return to automatic mode).

4.7 Add Stations

The Add Stations feature allows additional stations to be added to the current operating station group. Simultaneous station operation is important for testing system hydraulics and operation of multi-station irrigation systems.

Example: To add a station,



Station number 1 will operate in addition to any current station, which may be in operation. If no station is currently in operation, then station 1 will be the only station on.

Example: To turn the added stations off,



Additional stations may be added in the same manner.

Warning:  **The use of the Add Stations feature is limited to the maximum amperage supplied by the controller. Even though the Pro Max universal adapter is protected against over-current, it is possible that non-Rain Master controllers may blow a fuse and/or damage the controller if excessive current is drawn. Caution should be exercised when using this feature.**

Note: **The Add Stations only allows up to 5 stations and 1 master valve to be turned ON at the same time. Attempting to turn on a sixth station will turn the previous 5 stations off. The master valve will remain unaffected.**

4.7.1 Add Stations – On Key

Pressing the ON key during multiple station operation will turn off all stations except the one corresponding to the current number. The remote will resume standard remote operation executing only one station at a time.

4.7.2 Add Stations – Auto Up and Auto down Keys

Pressing AUTO UP or AUTO DOWN during multiple station operation will advance the previously entered number station accordingly and turn off all other stations. The remote will resume standard remote operations executing only one station at a time.

4.7.3 Add Stations - Off Key

If the OFF key is pressed during multiple station operations, all stations will be turned off.

If the OFF key is preceded by digits, then only the entered station number will be turned off.

4.8 Program Function

The Program feature is designed to be used only with the following Rain Master products:

- RME Sentar
- RME Hawk
- RME Eagle
- Evolution DX2 Controllers

The Program feature allows any program currently in the controller to be turned either on or off. This allows special programs to be executed for testing, evaluation, and supplemental irrigation cycles.

Example: To start Program 4,



To turn Program 4 off,



Once started, the program will run to completion whether or not the Pro Max receiver remains connected, whether the Access Code is turned off, or whether 60 minutes have elapsed.

4.8.1 Program – Off Key

Pressing the OFF key while the program is running will turn the program off and the controller returns to the Automatic Mode of the operation.

Similarly, when the program is completed, the controller returns to the Automatic Mode of operation.

4.8.2 Program – Auto up Key

Pressing the AUTO UP key while the program is running will advance the program to the next station. If the last station in the program is running, the program will terminate.

4.8.3 Program - Sensor Switches

The position of the Rain Switch will not affect the running of the program. The program will still run if the Rain Switch is in the “NO WATERING” position.

Programs configured under the control of sensors will continue to operate as configured. When a sensor detects sufficient watering, the program will shut off watering.

4.9 Minutes Function

The Minutes feature allows a station to be operated for a specified amount of time up to 60 minutes maximum. A station must first be selected and turned on prior to using the Minutes key.

Example: To turn on station 15 for 47 minutes,



The station will turn on immediately after pressing the ON key and all other stations will go off. The time count will start when the Minutes key has been pressed.

Note: If a station number is not entered, the currently selected station will be turned on for the specified time of 47 minutes.

The maximum allowable remote control operations time is 60 minutes.

When the selected station is on, the only 3 keys that are recognized are:

1. OFF Key – The OFF key will turn the station, the master valve or the pump off. The controller will return to the Automatic Mode.
2. AUTO UP - The current station turns off and the next sequential station turns on. The minute counter automatically re-starts.
3. AUTO DOWN - The current station turns off and the previous sequential station turns on. The minute counter automatically re-starts.

When the station run time is complete, either by the operator pressing the OFF key or the run time as elapsed, the controller will return to the status of a newly connected remote.

- AUTO UP will turn on station 1
- AUTO DOWN will turn on the next sequential station
- ADD STATIONS feature will do nothing, as there is no current number defined.

4.10 Beeper Operation

Beep tones are used to indicate the operational status of the Pro Max transmitter or Pro Max receiver. A valid beep occurs when a key is pressed and the Pro Max transmitter unit acknowledges the key entry by producing a single short tone burst. An invalid response occurs when a invalid key is pressed, resulting in a series of short tones going on and off continuously.

The Pro Max receiver will emit a valid beep whenever a valid command is received from the Pro Max transmitter. An invalid beep will occur whenever an illegal command sequence is received.

4.10.1 Power on Beeper Operation

When a Pro Max receiver is first powered on, a single beep is emitted for a duration of approximately 1/2 second. The single beep indicates that the Pro Max receiver is operational.

If the Pro Max receiver emits two beeps on power up this indicates that the Pro Max receiver is programmed for access code operation. Refer to section 4.6 for details on access code operation.

If the Pro Max receiver emits three beeps upon power up or at any other time, this indicates an invalid condition. Remove power and try again. If the invalid operational condition continues, contact your local Rain Master distributor.

4.10.2 Universal Adapter Over-Current Detection Beeper

If an over-current condition in the Universal Adapter has been detected, a beep sequence of once every six seconds will occur. This sequence will repeat until the power is cycled or the Controller Access Code times out.

4.11 Transmitter Battery Replacement

When the battery is low, the normal “beep” sound, which is emitted when a key is pressed, will instead be an intermittent fast beep. The battery should be replaced immediately.

The Pro Max transmitter battery is a 6-volt dual lithium battery pack, GE/Sanyo (CR-P2), Duracell (DL223A), Energizer (EL223AP) or equivalent. This battery is available at most retailers, including Radio Shack, Home Depot, or from your local Rain Master distributor.

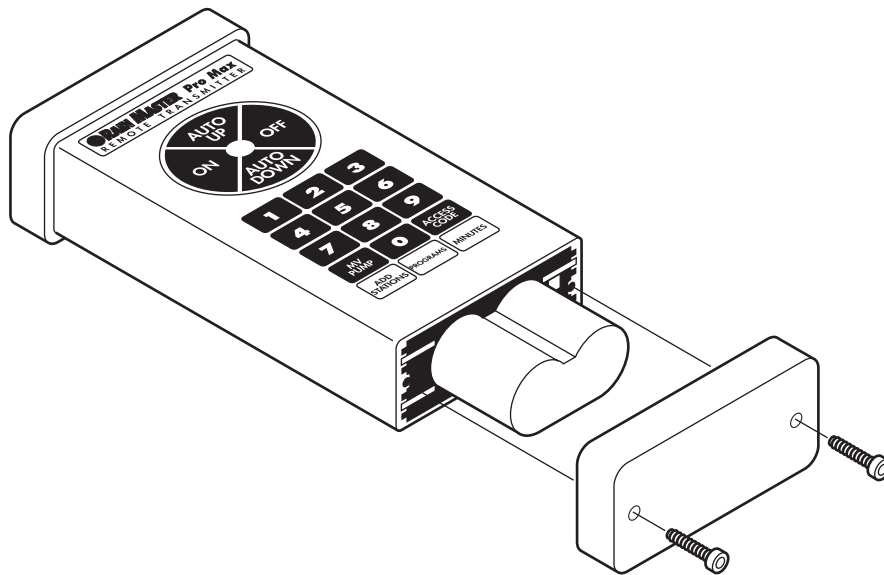

Figure 11: Battery Replacement

To replace the battery refer to Figure 11 and do the following steps:

- Step 1** Remove the two screws from the Pro Max transmitter bottom end cap. Pull the end cap off to expose the battery.
- Step 2** Remove the battery from the battery compartment.
- Step 3** The battery holder is designed with an extruded tab(s) in the center to prevent the battery from being installed backwards.

Position the new battery as shown and insert with the battery terminals facing into the Pro Max transmitter.

Note: Be sure to push battery all the way in.

Step 4 With the battery contacts properly mated; press the reset button located at the end of the circuit board, to reset the electronics.

Step 5 Replace the bottom rubber end-cap plate and secure it with the two screws. This ends the battery replacement procedure.

The Pro Max transmitter has been designed to minimize power consumption, to prolong battery life. Power is only consumed for a very short duration whenever a key is depressed.

Due to the various use of the Pro Max transmitter, it is impossible to predict exactly how long the battery will last. In general, you may expect a battery life of 6 to 12 months.

5.0 Checking Out Electrical Problems

5.1 Field Wiring Shorts, the Receiver, and Rain Master Controllers

If you suspect there is a short circuit in either the wiring or the solenoid of a station, then it is important to understand what will occur when you transmit a signal, to the controller, to turn on that station.

Example: If there is a short circuit on station 3 and you send a command to turn on Station 3, the controller will attempt to turn it on. If the controller has a built-in over-current detector (standard on the Rain Master RME Sentar, RME Hawk, RME Eagle, and Evolution DX2 controllers), the station will not be allowed to turn on. The user should isolate/repair the short-circuit and try again. The Pro Max system will remain fully operational.

5.2 Field Wiring Shorts, the Receiver, and Non Rain Master Controllers

The built-in over-current sensing capability of the Pro Max Universal Adapter protects the unit and controller transformer against damage due to short circuits in solenoids or field wiring. If you attempt to turn on a valve, which has a wiring problem, the Pro Max will sense the over-current and turn that station OFF immediately. The Pro Max receiver will beep every six seconds to indicate that you have attempted to operate a faulty station. Other stations will operate normally.

Once the problem is fixed, the station can be retried without having to walk back to the controller.

When you finish your testing and return to the controller, the beeping indicates that you have a problem with one or more stations. Power down and then up the Pro Max receiver, this will eliminate the beeping.

5.3 A Note about Solenoids

A solenoid should never be turned ON without a plunger in place. If this is done, the solenoid may draw from 2 to 5 times its normal electrical current. This will cause a rapid and dangerous heating cycle and may destroy the solenoid very quickly. Depending upon the solenoid, this electrical current may be enough to activate the attached controller's circuit breaker, pop the fuse, or damage the controller.

6.0 Troubleshooting

Pro Max System Troubleshooting	
Symptom	Action
No beep tone when Pro Max transmitter key is pressed.	Replace Battery.
No beep tone when Pro Max transmitter is pressed after changing the battery.	Remove end cap and press the Pro Max transmitter-reset button. Ref. Figure 10 Page 33.
“Rapid beeps” when Pro Max transmitter key is pressed.	Replace battery. Rapid beeps indicate low battery condition.
Key presses beep at the Pro Max transmitter but no valves turn ON at Rain Master controller.	<ul style="list-style-type: none"> • Check installation and antenna connections. • Remove PM-SER99 cable from the controller and then re-insert. • Upon re-insertion of the cable listen for a Pro Max receiver tone(s). <ul style="list-style-type: none"> - One tone OK (approximately 1/2 second) - Two tones OK (see Section 4.6 Access Codes) - Any other tones (contact factory) • Press the AUTO UP key and listen for a confirmation beep at the Pro Max receiver. If no beep heard contact factory. <ul style="list-style-type: none"> - The controller display should show remote station activity as AUTO UP is pressed. If nothing displayed contact factory. • Verify water is ON at selected stations. If no water is available, is a Master Valve/Pump required? Verify field station wiring is correct. • Confirm that the remote continues to work at maximum distance. If not, contact factory.
Receiver beeps once every six seconds continuously. For non-Rain Master controller. (Model Pro	<ul style="list-style-type: none"> • The universal adapter has detected an electrical short circuit when attempting to turn ON a station.

Pro Max System Troubleshooting	
Symptom	Action
Max-UA)	<ul style="list-style-type: none"> - Check the valve solenoid and replace if necessary. - Check the station wiring for short circuit to common, check for insulation nicks and exposed wiring in standing water. - When field problem is fixed, turn station back ON. - Cycle Pro Max receiver power to reset the unit. <p>Note: The Pro Max system will continue to operate normally for non-shortened stations.</p>
Keys beep at Pro Max transmitter but no valves turn on at a non Rain Master controller. (Model Pro Max-UA)	<ul style="list-style-type: none"> • Check installation, and antenna connections (see Section 3.2, Figure 8 and Figure 9) • Remove the large 37-pin connector from the universal adapter assembly and then re-insert. • Upon re-insertion of the cable listen for the Pro Max receiver tone(s). <ul style="list-style-type: none"> - No tone – check the 24 Volts AC and common connections. - One tone, OK (approximately 1/2 second) - Two tones, OK (see Section 4.6 Access Code) - Any other tones (contact factory) • Press the AUTO UP key and listen for a confirmation beep at the Pro Max receiver. If no beep contact factory. • Verify water is ON at the selected stations. If no water is available, is a Master Valve/Pump required? Verify field station wiring is correct. • Confirm that the remote continues to work at maximum distance. If not, contact factory.

7.0 Pro Max Specifications

7.1 Pro Max Transmitter

Operating Frequency.....	154.600 MHz
Modulation type	Frequency Modulation
Frequency Stability.....	.005%
Power Output.....	1 Watt nominal
Power Source.....	One 6 volt type CR-P2 lithium battery
Operating Temperature Range...	0 to 60 degrees Celsius (32 to 140 ° Fahrenheit)
Storage Temperature Range.....	-20 to 70 degrees Celsius (-4 to 158 ° Fahrenheit)
Humidity Range.....	0 to 90% non-condensing
Battery.....	CR-P2 Lithium 6V (user replaceable)
Battery Life Expectancy.....	1 season (typical)
Dimensions.....	3"L x 1 3/8"W x 5 1/2"H (less antenna)
Weight.....	12 oz.

7.2 Pro Max Receiver

Operating Frequency.....	154.600 MHz
Sensitivity.....	0.4 micro-volt typical
Power Source.....	22 – 32 Volts AC 50/60 Hz.
Operating Temperature Range...	0 to 60 degrees Celsius (32 to 140 ° Fahrenheit)
Storage Temperature Range...	-20 to 70 degrees Celsius (-4 to 158 ° Fahrenheit)
Humidity Range.....	0 to 90% non-condensing
Dimensions.....	6 1/4"L x 3 1/4"W x 1 1/16"H *
Weight.....	11 oz.

7.3 Pro Max Universal Adapter

Power Source.....	22 – 32 Volts AC 50/60 Hz.
Operating Temperature Range...	0 to 60 degrees Celsius (32 to 140 ° Fahrenheit)
Storage Temperature Range...	-20 to 70 degrees Celsius (-4 to 158 ° Fahrenheit)
Humidity Range.....	0 to 90% non-condensing
Output Capability.....	1 amp/station, 1.5 amp total
Dimensions.....	6 1/4"L x 3 1/4"W x 1 1/16"H *
Weight.....	13 oz.

*Connectors not included

7.4 Pro Max Carrying Case

Dimensions.....	12 1/2"L x 7 1/2"W x 10"H
-----------------	---------------------------

8.0 Pro Max Series Parts List

<u>Model</u>	<u>Description</u>
Pro Max	The complete remote set for Rain Master Controllers
Pro Max-UA	The complete remote set for Non-Rain Master Controllers, include universal adaptor.
<u>Accessories</u>	<u>Description</u>
PMRKIT	Permanent mount remote Pro Max receiver, includes antenna (PM-PM-ANT) cables & hardware.
CMAD	Chassis mount access door, gives access to the permanent connectors through the wall of other manufacturers controllers.
12PC	30" permanent connector cable for 12 stations and Master Valve/Pump on non-Rain Master controllers.
RMIS Part Number 24PC	30" permanent connector cable for 24 stations and Master Valve/Pump on non-Rain Master controllers.
RMIS Part Number 32PC	30" permanent connector for cable 32 stations and Master Valve/Pump on non-Rain Master controllers.
RMIS Part Number 32TC	60" temporary connector with alligator clips, for up to 32 stations and Master Valve/Pump on non-Rain Master controllers
RMIS Part Number 32EX	48" extension cable to connect to Pro Max receiver and PC or TC cables (Typical use with CMAD)
<u>Pro Max Replacement Parts</u>	<u>Description</u>
PM-XMTR	Pro Max remote Pro Max transmitter, includes battery and antenna (PM-XMTR-ANT)
PM-RCVR	Pro Max remote Pro Max receiver and antenna (PM-RCVR-ANT)
PM-UADAPT	Universal adapter (32 station and Master Valve/Pump output control)
PM-PM-ANT	Pro Max permanent mount 16" chassis antenna
PM-PM-ANT2	Pro Max permanent mount Low-Profile, encapsulated chassis mounted antenna
PM-RCVR-ANT*	Replacement antenna for Pro Max receiver (right angle)
PM-XMTR-ANT*	Replacement antenna for Pro Max transmitter
PM-SER99	36" remote cable with a DB9 (9-pin) connector
<u>Option</u>	<u>Description</u>
417-2013	Receiver connection cable for Rain Master controllers with rear permanent mount interface.
PM-CASE	Pro Max Remote Case
JACK-IRC	Factory installed rear permanent interface RME Hawk, RME Sentar & Evolution DX2 only. Includes access code

- (Add – T to these parts for telescope high gain version.)

Rain Master Limited Warranty

Rain Master Irrigation Systems Inc. warrants to the first customer purchaser that this Rain Master brand product (the “product”), when shipped in its original container, will be free from defective workmanship, and materials and agrees that it will, at its option, either repair the defect or replace the defective product or part thereof at no charge to the purchaser for parts or labor for the time period set forth below.

This warranty does not apply to any appearance items of the product nor to any product has the exterior of which been altered or modified in design or construction. (See additional exclusion below). This limited warranty described above is in addition to whatever implied warranties may be granted to purchasers by law.

This limited warranty does not apply to product failure caused by improper installation or grounding, improper handling, physical abuse, neglect, whether accidental or malicious, acts of God, such as lightning and/or power surges, floods, earthquakes, hurricane, tornados, vandalism etc.

(All implied warranties including the warranty of merchantability, and fit for use are limited to the period(s) from date of purchase set forth below).

Neither the sales personnel of the seller nor any other person is authorized to make any warranties other than those described above, or to extend the duration of any warranties beyond the time period described herein.

The warranties described above shall be the sole and exclusive warranties granted by Rain Master Irrigation Systems Inc. and shall be the sole and exclusive remedy available to the purchaser. Correction of defects, in the manner and period of time described herein, shall constitute complete fulfillment of all liabilities and responsibilities of Rain Master to the purchaser with respect to the product, and shall constitute full satisfaction of all claims, whether based on contract, negligence, strict liability or otherwise.

In no event shall Rain Master be liable or in any way responsible, for any damages or defects in the product which were caused by repairs or attempted repairs performed by anyone other than a Rain Master Service dealer or center. Nor shall Rain Master be liable or in any way responsible for an incidental or consequential economic or property damage. Some states do not allow the exclusion of incidental or consequential damages, so the above exclusion may not apply to you. The Rain Master Pro Max series products carry a 2 year limited warranty unless otherwise specified. In order to enforce the rights of this limited warranty, please follow the directions as described in the following sections.

SERVICE

Prior to sending your Pro Max system for service:

1. Please refer to the troubleshooting section of the manual for possible solutions.
2. Contact Rain Master Technical Support at (805) 527-4498. Be sure you can describe your problem(s) and if possible, be able to reproduce your problem(s) while ON the phone. You will need the serial numbers of both your Pro Max transmitter and Pro Max receiver.
3. If required to ship, ensure the unit is properly packaged, preferably in the original shipping case. Include all cables and components, and make sure adequate packaging material is used to protect the unit(s) from shipping abuse.

4. Enclose a complete description of the type of problem that is occurring, and be sure to include your name, address and phone number where you can be reached.
5. Product can be:
 - A. Sent or take to an authorized Rain Master Distributor. Call Rain Master at (805) 527-4498 for nearest distributor.
 - B. Sent or take to:
Rain Master Irrigation Systems
Attn: Service Dept.
310-B Royal Ave.
Simi Valley, CA 93063

Warning: This equipment has been tested and found to comply with the limits for Class A digital device pursuant to part 15 of the FCC Rules. These limits are designed to provide reasonable protection against harmful interference when the equipment is operated in a commercial environment. This equipment generates, uses, and can radiate radio frequency energy and if not installed and used in accordance with the instruction manual, may cause interference to radio communications. Operation of this equipment in a residential area is likely to cause interference in which case the user will be required to correct the interference at the user's expense.

The user is cautioned that changes and modifications made to the equipment without approval of the manufacturer could void the user's authority to operate this equipment.

Wiring List for PROMAX-UA

Station	Base Color	1 st Stripe Color	2 nd Stripe Color	Cable
1	Black			Large
2	White			Large
3	Red			Large
4	Green			Large
5	Orange			Large
6	Blue			Large
7	White	Black		Large
8	Red	Black		Large
9	Green	Black		Large
10	Orange	Black		Large
11	Blue	Black		Large
12	Black	White		Large
13	Blue	Red		Large
14	Red	Green		Large
15	Orange	Green		Large
16	Black	White	Red	Large
17	White	Black	Red	Large
18	Red	Black	White	Large
19	Green	Black	White	Large
20	Orange	Black	White	Large
21	Blue	Black	White	Large
22	Black	Red	Green	Large
23	White	Red	Green	Large
24	Red	Black	Green	Large
25	Black			Small
26	White			Small
27	Red			Small
28	Green			Small
29	Brown			Small
30	Blue			Small
31	Orange			Small
32	Yellow			Small
MV/P	Green	White		Large
COMMON	Orange	Red	(Standard)	Large
COMMON*	Red	White		Large
24 VAC	Blue	White		Large

*Some cables may use this color scheme for common



3910-B Royal Avenue
 Simi Valley, California 93063
 Telephone: (805) 527-4498 Fax: (805) 527-2813
www.Rainmaster.com