



Swan sets  
the Standard  
in Walls



Again...



& Again.





## 12-inch Square Tile Wall

Our gracious, 12-inch square pattern highlights the beauty of Swanstone. Artfully chamfered edges suggest the high-end look of a travertine installation without the labor, materials and time demands of tile. And Swanstone is durable, easy to clean and resists stains – in fact, it’s virtually maintenance-free.





## Square Tile Wall Kits

Model	Part	Dimensions
SQMK72-3636	SQMK723636	36" x 36" x 72 1/2"
SQMK96-3636	SQMK963636	36" x 36" x 96"

Designed to fit bases 36" wide x 36" deep or smaller; 72" or 96" High

**Kit includes:** Two side panels, one back panel, two corner soap dishes, installation materials and complete installation instructions.

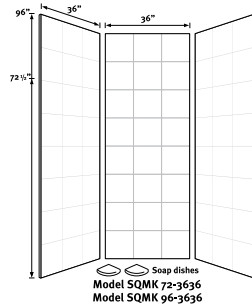

Model	Part	Dimensions
SQMK72-3648	SQMK723648	36" x 48" x 72 1/2"
SQMK96-3648	SQMK963648	36" x 48" x 96"

Designed to fit bases 48" wide x 36" deep or smaller; 72" or 96" High

**Kit includes:** Two side panels, one back panel, two corner soap dishes, installation materials and complete installation instructions.

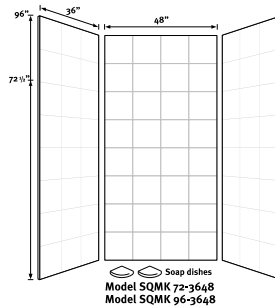

Model	Part	Dimensions
SQMK72-3662	SQMK723662	36" x 62" x 72 1/2"
SQMK96-3662	SQMK963662	36" x 62" x 96"

Designed to fit bases 62" wide x 36" deep or smaller; 72" or 96" High

**Kit includes:** Two side panels, one back panel, two corner soap dishes, installation materials and complete installation instructions.

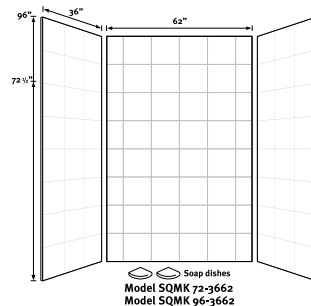

Model	Part	Dimensions
SQMK72-4848	SQMK724848	48" x 48" x 72 1/2"
SQMK96-4848	SQMK964848	48" x 48" x 96"

Designed to fit bases 48" wide x 48" deep or smaller; 72" or 96" High

**Kit includes:** Two side panels, one back panel, two corner soap dishes, installation materials and complete installation instructions.

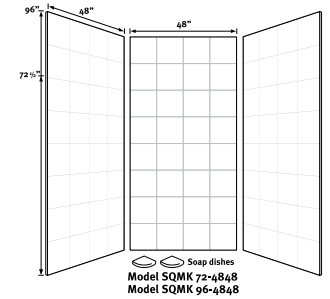

### Swanstone Square Tile Neo Angle Kits

Model	Part	Dimensions
SQMK72-48NEO	SQMK7248NEO	48" x 48" x 72 1/2"
SQMK96-48NEO	SQMK9648NEO	48" x 48" x 96"

Designed to fit bases 48" wide x 48" deep or smaller; 72" or 96" High

**Kit includes:** Two side panels, two corner soap dishes, installation materials and complete installation instructions.

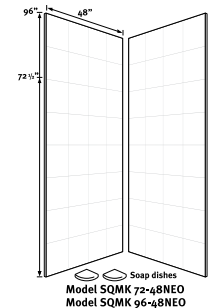

## Square Tile Wall Panels

### Single Wall Panels

Model	Part	Dimensions
SSSQ-3696-1	SSSQ369601	36" x 96"
SSSQ-6296-1	SSSQ629601	62" x 96"

**Kit Includes:** One panel and complete installation instructions.

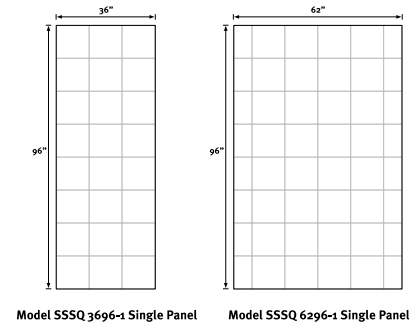

**Colors:** See complete color listing on page 8. **Packaging:** Packaged in individual carton.

Use our Online Shower Selection Tool for quick and easy bathroom planning.

For an interactive shower selection experience, try our Shower Selection Tool at swanstone.com. Create your ideal shower, visualize it, and our tool will generate a list with exactly what parts you need. It makes shower selection a snap! [Click Here.](#)





# Subway Tile Wall

Subway tile is a design classic that never goes out of style. Our 3 x 6 inch pattern delivers the beauty of a subway tile installation in an easy-to-install product. Another big advantage over tile? No grout to maintain – making these walls perfect for commercial, residential and rental property applications.



## Subway Tile Wall Kits

Model	Part	Dimensions
STMK72-3636	STMK723636	36" x 36" x 72 1/2"
STMK96-3636	STMK963636	36" x 36" x 96"

Designed to fit bases 36" wide x 36" deep or smaller; 72" or 96" High

**Kit includes:** Two side panels, one back panel, two corner soap dishes, installation materials and complete installation instructions.

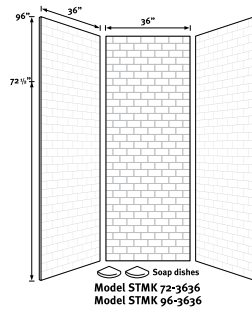

Model	Part	Dimensions
STMK72-3648	STMK723648	36" x 48" x 72 1/2"
STMK96-3648	STMK963648	36" x 48" x 96"

Designed to fit bases 48" wide x 36" deep or smaller; 72" or 96" High

**Kit includes:** Two side panels, one back panel, two corner soap dishes, installation materials and complete installation instructions.

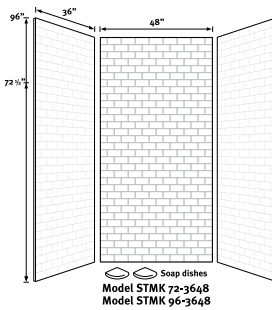

Model	Part	Dimensions
STMK72-3662	STMK723662	36" x 62" x 72 1/2"
STMK96-3662	STMK963662	36" x 62" x 96"

Designed to fit bases 62" wide x 36" deep or smaller; 72" or 96" High

**Kit includes:** Two side panels, one back panel, two corner soap dishes, installation materials and complete installation instructions.

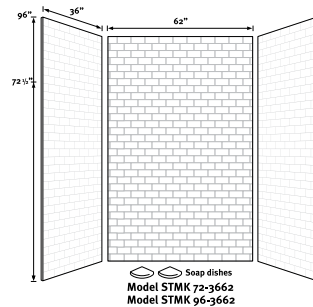

Model	Part	Dimensions
STMK72-4848	STMK724848	48" x 48" x 72 1/2"
STMK96-4848	STMK964848	48" x 48" x 96"

Designed to fit bases 48" wide x 48" deep or smaller; 72" or 96" High

**Kit includes:** Two side panels, one back panel, two corner soap dishes, installation materials and complete installation instructions.

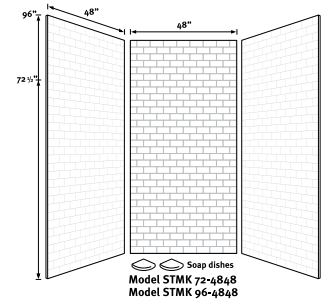

### Swanstone Subway Tile Neo Angle Kits

Model	Part	Dimensions
STMK72-48NEO	STMK7248NEO	48" x 48" x 72 1/2"
STMK96-48NEO	STMK9648NEO	48" x 48" x 96"

Designed to fit bases 48" wide x 48" deep or smaller; 72" or 96" High

**Kit includes:** Two side panels, two corner soap dishes, installation materials and complete installation instructions.

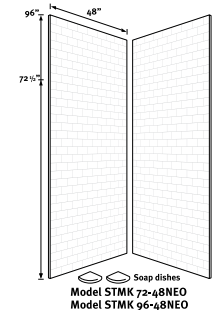

## Subway Tile Wall Panels

### Single Wall Panels

Model	Part	Dimensions
SSST-3696-1	SSST369601	36" x 96"
SSST-6296-1	SSST629601	62" x 96"

**Kit Includes:** One panel and complete installation instructions.

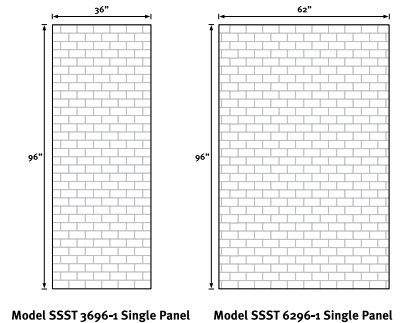

**Colors:** See complete color listing on page 8. **Packaging:** Packaged in individual carton.

Use our Online Shower Selection Tool for quick and easy bathroom planning.

For an interactive shower selection experience, try our Shower Selection Tool at swanstone.com. Create your ideal shower, visualize it, and our tool will generate a list with exactly what parts you need. It makes shower selection a snap! [Click Here.](#)



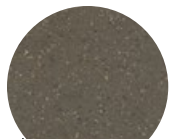

Acorn

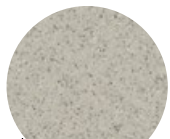

Almond Galaxy

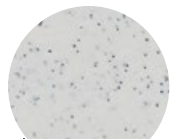

Arctic Granite



Baby's Breath



Barley



Bermuda Sand



Bisque



Bone

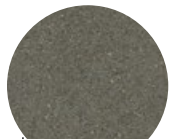

Canyon



Caraway Seed



Cloud Bone



Cloud White



Cornflower



Glacier

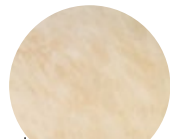

Golden Steppe

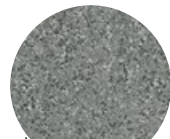

Gray Granite



Ice

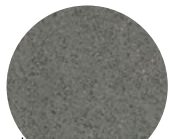

Indian Grass



Mountain Haze

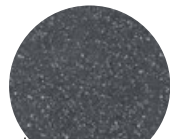

Night Sky



Pebble



Prairie

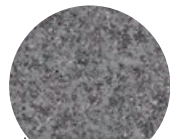

Purple Sage



Seafoam



Sierra

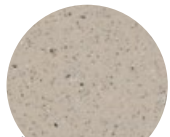

Tahiti Desert

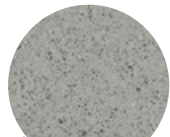

Tahiti Gray



Tahiti Ivory



Tahiti Matrix



Tahiti Sand



Tahiti Terra



Tahiti White



Tundra

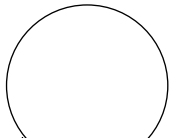

White



Winter Wheat

Our Swanstone Walls are available in a big, beautiful range of designer colors to fit your lifestyle.

[Click here](#) to get more information on Swanstone's designer colors.



# Swanstone means Low Maintenance, High Performance Walls



When it comes to durability, Swanstone is the best high-performance surface for residential, rental and commercial applications.

And we can prove it >



**Heat resistant to 450°** – the best in the industry. Boiling water, curling irons, even flat irons will not harm it.



**Five times stronger** than other solid surfaces, Swanstone won't break, even when hit with a hammer.



Want to see Swanstone in action? [Click here](#) to see our heat, impact and chemical test videos.



**Swanstone is impervious to damage from common household culprits.**

Acetone will not etch it; cosmetics and beverages, like coffee and cola, cannot permanently stain it.



Want to see Swanstone in action? [Click here](#) to see our heat, impact and chemical test videos.





Color and texture are consistent throughout, with **no surface coating to crack or chip**. Compression molded, not cast, Swanstone **will not crack or craze** like other materials — and it's easy to maintain, since it **won't mold or mildew**.



Want to see Swanstone in action? [Click here](#) to see our heat, impact and chemical test videos.





Transform your entire bath with the beauty and durability of Swanstone.

We're excited about our designer walls, but they're just part of the story – you can transform your whole bath with the beauty and durability of Swanstone. We even have ADA-compliant products to make life easier for people who need it most.

Our high-performance surface stands up beautifully to everyday use. From shower walls, floors and accessories to vanity tops/bowls, wainscoting, molding and trim, Swanstone offers you a complete suite of beautiful and durable bath solutions.

[Click here](#) for detailed information about Swanstone's entire family of bath products, including features, product selectors, installation guides and technical specifications.

1. Vanity Top and Bowls
2. Shower Walls
3. Accessories
4. Shower Floors
5. Custom Tub Deck
6. Wainscoting

Our entire family of low-maintenance, high-performance Swanstone products leads the industry, delivering beauty and incredible durability in an impressive range of designer colors and textures. In short, exactly what you've come to expect from Swan.



Want to learn more about our Swanstone walls and bath products – or better yet, ready to get started designing your own project? We're ready to help! [Click here.](#)