



Buy it for looks. Buy it for life.®

Specifications

DESCRIPTION

- Metal construction with various finishes identified by suffix
- Includes showerhead, arm, flange and diverter tub spout

OPERATION

- Handle operates counterclockwise through a 270° arc with off at 6 o'clock and maximum hot at the 9 o'clock position. Shut off in clockwise direction
- Adjustable temperature limit stop to control maximum hot water temperature
- Pressure balancing mechanism maintains selected discharge temperature to ± 3°

FLOW

- Showerhead is limited to 2.5 gpm (9.5 L/min) at 80 psi
- EP suffix models are limited to 1.75 gpm (6.6 L/min) at 80 psi

CARTRIDGE

- 1222 cartridge design
- Accommodates back to back installations
- Nonmetallic, nonferrous and stainless steel material

STANDARDS

- Third party certified to meet ASME A112.18.1/CSA B125.1 and all applicable requirements referenced therein
- EP suffix models are third party certified to WaterSense®
- ADA ♿ for lever handle

WARRANTY

- Limited lifetime warranty against leaks, drips and finish defects to the original consumer purchaser
- 5 year warranty if used in commercial installations

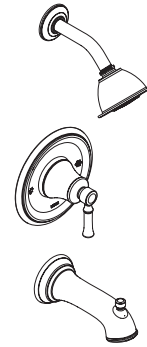

DARTMOOR™ Single-Handle Tub/Shower Trim Kit

Models: T2181 series - valve trim only
 T2182 series - shower trim only
 T2183 series - tub/shower trim
 T62182 (bulk)
 T62183 (bulk)

Valves: 62300 series
 2500 series

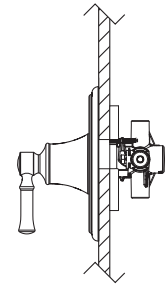
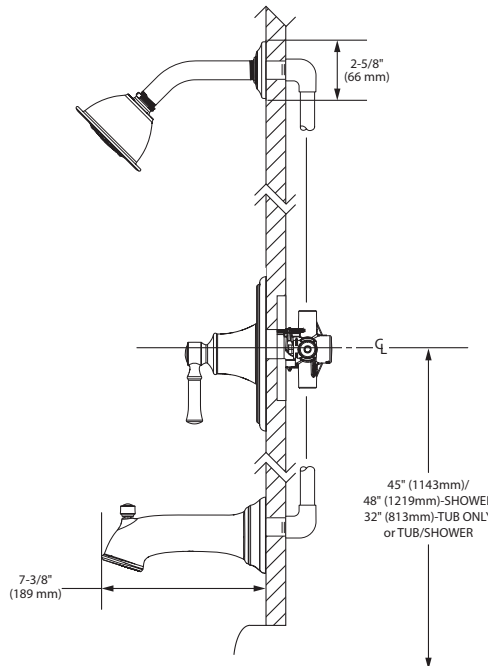
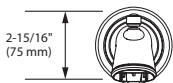
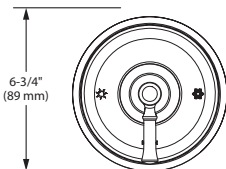
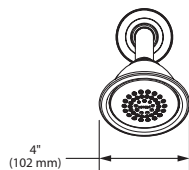
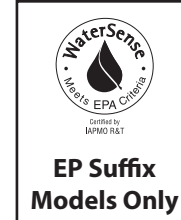

THICK WALL APPLICATION

THIN WALL APPLICATION



CRITICAL DIMENSIONS

(DO NOT SCALE)