

INSTRUCTION MANUAL

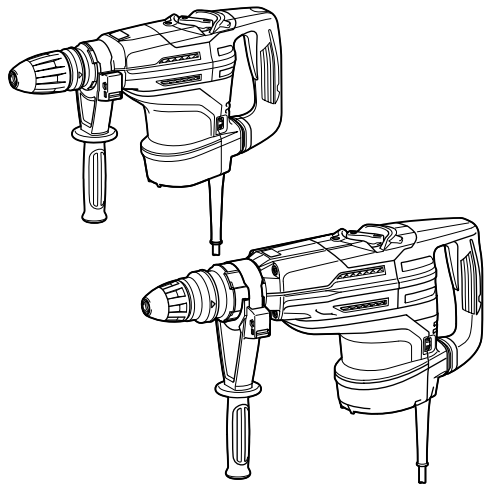

Rotary Hammer

HR4003C
HR4013C
HR5202C
HR5212C



DOUBLE INSULATION

014873

IMPORTANT: Read Before Using.

ENGLISH (Original instructions)

SPECIFICATIONS

Model		HR4003C	HR4013C	HR5202C	HR5212C
Capacities	Carbide-tipped bit	40 mm		52 mm	
	Core bit	105 mm		160 mm	
No load speed (min ⁻¹)		250 - 500		150 - 310	
Blows per minute		1,450 - 2,900		1,100 - 2,250	
Overall length		479 mm		599 mm	
Net weight		6.2 kg	6.8 kg	10.9 kg	11.9 kg
Safety class		II/III			

- Due to our continuing program of research and development, the specifications herein are subject to change without notice.
- Specifications may differ from country to country.
- Weight according to EPTA-Procedure 01/2003

END201-7

GEA005-3

Symbols

The following show the symbols used for the equipment. Be sure that you understand their meaning before use.



- Read instruction manual.



- DOUBLE INSULATION



- Only for EU countries
Do not dispose of electric equipment together with household waste material!
In observance of the European Directive, on Waste Electric and Electronic Equipment and its implementation in accordance with national law, electric equipment that have reached the end of their life must be collected separately and returned to an environmentally compatible recycling facility.

ENE044-1

Intended use

The tool is intended for hammer drilling in brick, concrete and stone as well as for chiselling work.

ENF002-2

Power supply

The tool should be connected only to a power supply of the same voltage as indicated on the nameplate, and can only be operated on single-phase AC supply. They are double-insulated and can, therefore, also be used from sockets without earth wire.

General Power Tool Safety Warnings

⚠ WARNING Read all safety warnings and all instructions. Failure to follow the warnings and instructions may result in electric shock, fire and/or serious injury.

Save all warnings and instructions for future reference.

The term "power tool" in the warnings refers to your mains-operated (corded) power tool or battery-operated (cordless) power tool.

Work area safety

1. **Keep work area clean and well lit.** Cluttered or dark areas invite accidents.
2. **Do not operate power tools in explosive atmospheres, such as in the presence of flammable liquids, gases or dust.** Power tools create sparks which may ignite the dust or fumes.
3. **Keep children and bystanders away while operating a power tool.** Distractions can cause you to lose control.

Electrical safety

4. **Power tool plugs must match the outlet. Never modify the plug in any way. Do not use any adapter plugs with earthed (grounded) power tools.** Unmodified plugs and matching outlets will reduce risk of electric shock.
5. **Avoid body contact with earthed or grounded surfaces such as pipes, radiators, ranges and refrigerators.** There is an increased risk of electric shock if your body is earthed or grounded.
6. **Do not expose power tools to rain or wet conditions.** Water entering a power tool will increase the risk of electric shock.

7. **Do not abuse the cord. Never use the cord for carrying, pulling or unplugging the power tool. Keep cord away from heat, oil, sharp edges or moving parts.** Damaged or entangled cords increase the risk of electric shock.
8. **When operating a power tool outdoors, use an extension cord suitable for outdoor use.** Use of a cord suitable for outdoor use reduces the risk of electric shock.
9. **If operating a power tool in a damp location is unavoidable, use a residual current device (RCD) protected supply.** Use of an RCD reduces the risk of electric shock.
10. **Use of power supply via a RCD with a rated residual current of 30mA or less is always recommended.**

Personal safety

11. **Stay alert, watch what you are doing and use common sense when operating a power tool. Do not use a power tool while you are tired or under the influence of drugs, alcohol or medication.** A moment of inattention while operating power tools may result in serious personal injury.
12. **Use personal protective equipment. Always wear eye protection.** Protective equipment such as dust mask, non-skid safety shoes, hard hat, or hearing protection used for appropriate conditions will reduce personal injuries.
13. **Prevent unintentional starting. Ensure the switch is in the off-position before connecting to power source and/or battery pack, picking up or carrying the tool.** Carrying power tools with your finger on the switch or energising power tools that have the switch on invites accidents.
14. **Remove any adjusting key or wrench before turning the power tool on.** A wrench or a key left attached to a rotating part of the power tool may result in personal injury.
15. **Do not overreach. Keep proper footing and balance at all times.** This enables better control of the power tool in unexpected situations.
16. **Dress properly. Do not wear loose clothing or jewellery. Keep your hair, clothing, and gloves away from moving parts.** Loose clothes, jewellery or long hair can be caught in moving parts.
17. **If devices are provided for the connection of dust extraction and collection facilities, ensure these are connected and properly used.** Use of dust collection can reduce dust-related hazards.

Power tool use and care

18. **Do not force the power tool. Use the correct power tool for your application.** The correct power tool will do the job better and safer at the rate for which it was designed.
19. **Do not use the power tool if the switch does not turn it on and off.** Any power tool that cannot be controlled with the switch is dangerous and must be repaired.
20. **Disconnect the plug from the power source and/or the battery pack from the power tool before making any adjustments, changing accessories, or storing power tools.** Such preventive safety measures reduce the risk of starting the power tool accidentally.
21. **Store idle power tools out of the reach of children and do not allow persons unfamiliar with the power tool or these instructions to operate the power tool.** Power tools are dangerous in the hands of untrained users.
22. **Maintain power tools. Check for misalignment or binding of moving parts, breakage of parts and any other condition that may affect the power tool's operation. If damaged, have the power tool repaired before use.** Many accidents are caused by poorly maintained power tools.
23. **Keep cutting tools sharp and clean.** Properly maintained cutting tools with sharp cutting edges are less likely to bind and are easier to control.
24. **Use the power tool, accessories and tool bits etc. in accordance with these instructions, taking into account the working conditions and the work to be performed.** Use of the power tool for operations different from those intended could result in a hazardous situation.

Service

25. **Have your power tool serviced by a qualified repair person using only identical replacement parts.** This will ensure that the safety of the power tool is maintained.
26. **Follow instruction for lubricating and changing accessories.**
27. **Keep handles dry, clean and free from oil and grease.**

GEB007-7

ROTARY HAMMER SAFETY WARNINGS

1. **Wear ear protectors.** Exposure to noise can cause hearing loss.
2. **Use auxiliary handle(s), if supplied with the tool.** Loss of control can cause personal injury.

3. Hold power tool by insulated gripping surfaces, when performing an operation where the cutting accessory may contact hidden wiring or its own cord. Cutting accessory contacting a "live" wire may make exposed metal parts of the power tool "live" and could give the operator an electric shock.
4. Wear a hard hat (safety helmet), safety glasses and/or face shield. Ordinary eye or sun glasses are NOT safety glasses. It is also highly recommended that you wear a dust mask and thickly padded gloves.
5. Be sure the bit is secured in place before operation.
6. Under normal operation, the tool is designed to produce vibration. The screws can come loose easily, causing a breakdown or accident. Check tightness of screws carefully before operation.
7. In cold weather or when the tool has not been used for a long time, let the tool warm up for a while by operating it under no load. This will loosen up the lubrication. Without proper warm-up, hammering operation is difficult.
8. Always be sure you have a firm footing. Be sure no one is below when using the tool in high locations.
9. Hold the tool firmly with both hands.
10. Keep hands away from moving parts.
11. Do not leave the tool running. Operate the tool only when hand-held.
12. Do not point the tool at any one in the area when operating. The bit could fly out and injure someone seriously.
13. Do not touch the bit or parts close to the bit immediately after operation; they may be extremely hot and could burn your skin.
14. Some material contains chemicals which may be toxic. Take caution to prevent dust inhalation and skin contact. Follow material supplier safety data.

SAVE THESE INSTRUCTIONS.

⚠WARNING:

DO NOT let comfort or familiarity with product (gained from repeated use) replace strict adherence to safety rules for the subject product. **MISUSE** or failure to follow the safety rules stated in this instruction manual may cause serious personal injury.

FUNCTIONAL DESCRIPTION

⚠CAUTION:



- Always be sure that the tool is switched off and unplugged before adjusting or checking function on the tool.

Switch action

⚠CAUTION:

- Before plugging in the tool, always check to see that the switch trigger actuates properly and returns to the "OFF" position when released.

Switch trigger

This switch functions when setting the tool in  symbol and  symbol modes.

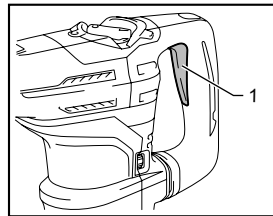

1. Switch trigger

014028

To start the tool, simply pull the switch trigger. Release the switch trigger to stop.

Switch button

This switch functions when setting the tool in  symbol mode.

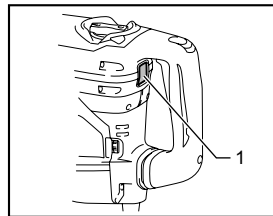

1. Switch button

014880

When the tool is in the  symbol mode, the switch button projects out and lights in red.

To start the tool, press the switch button. The switch light turns in green.

To stop the tool, press the switch button again.

Speed change

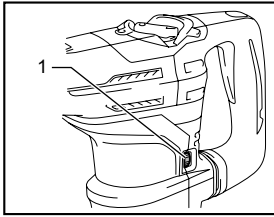

1. Adjusting dial

014029

The revolutions and blows per minute can be adjusted just by turning the adjusting dial. The dial is marked 1 (lowest speed) to 5 (full speed).

Refer to the table below for the relationship between the number settings on the adjusting dial and the revolutions/blows per minute.

For Model HR4003C, HR4013C

Number on adjusting dial	Revolutions per minute	Blows per minute
5	500	2,900
4	470	2,700
3	380	2,150
2	290	1,650
1	250	1,450

014134

For Model HR5202C, HR5212C

Number on adjusting dial	Revolutions per minute	Blows per minute
5	310	2,250
4	290	2,100
3	230	1,700
2	180	1,300
1	150	1,100

014872

For model HR4013C, HR5212C only

NOTE:

- Blows at no load per minute becomes smaller than those on load in order to reduce vibration under no load, but this does not show trouble. Once operation starts with a bit against concrete, blows per minute increase and get to the numbers as shown in the table. When temperature is low and there is less fluidity in grease, the tool may not have this function even with the motor rotating.

⚠CAUTION:

- If the tool is operated continuously at low speeds for a long time, the motor may get overloaded, resulting in tool malfunction.

- The speed adjusting dial can be turned only as far as 5 and back to 1. Do not force it past 5 or 1, or the speed adjusting function may no longer work.

Selecting the action mode

⚠CAUTION:

- Do not rotate the change lever when the tool is running. The tool will be damaged.
- To avoid rapid wear on the mode change mechanism, be sure that the change lever is always positively located in one of the action mode positions.

Hammer drilling mode

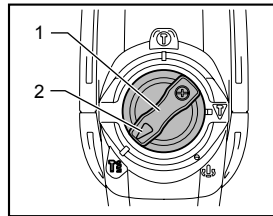

1. Change lever
2. Pointer

014022

For drilling in concrete, masonry, etc., rotate the change lever to the symbol. Use a tungsten-carbide tipped bit.

Hammering mode (Switch trigger mode)

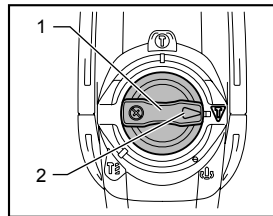

1. Change lever
2. Pointer

014024

For chipping, scaling or demolition operations, rotate the change lever to the symbol. Use a bull point, cold chisel, scaling chisel, etc.

Hammering mode (Switch button mode)

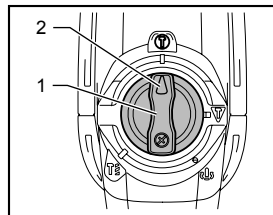

1. Change lever
2. Pointer

014023

For continuous chipping, scaling or demolition operations, rotate the change lever to the symbol.

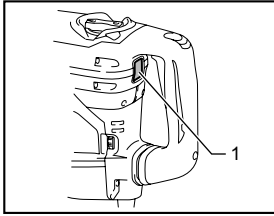

1. Switch button

014880

The switch button projects out and lights in red. Use a bull point, cold chisel, scaling chisel, etc.

NOTE:

- When using the tool in the  symbol mode, the switch trigger does not work but only the switch button works.

Torque limiter

The torque limiter actuates when torque reaches a certain level. The motor disengages from the output shaft. When this happens, the bit stops turning.

⚠CAUTION:

- As soon as the torque limiter actuates, switch off the tool immediately. This helps to prevent premature wear of the tool.

Indicator lamp

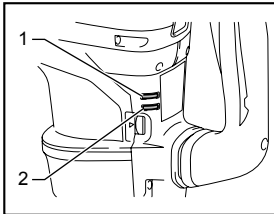

1. Power-ON indicator lamp (green)
2. Service indicator lamp (red)

014032

The green power-ON indicator lamp lights up when the tool is plugged in. If the indicator lamp does not light up, the mains cord or the controller may be defective.

When the indicator lamp lights up but the tool does not start even the tool is switched on, the carbon brushes may be worn out, or the controller, the motor or the ON/OFF switch may be defective.

If above symptoms occur, stop using the tool immediately and ask your local service center.

The red service indicator lamp lights up when the carbon brushes are nearly worn out to indicate that the tool needs servicing. After some period of use, the motor automatically shuts off.

ASSEMBLY

⚠CAUTION:

- Always be sure that the tool is switched off and unplugged before carrying out any work on the tool.

Side handle

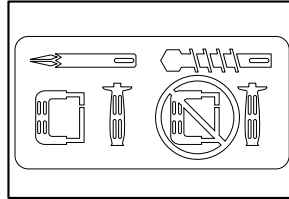

003139

⚠CAUTION:

- Use the side handle only when chipping, scaling or demolishing. Do not use it when drilling in concrete, masonry, etc. The tool cannot be held properly with this side handle when drilling.

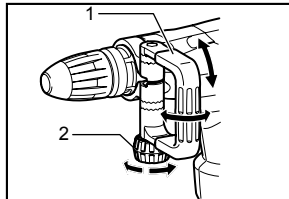

1. Side handle
2. Clamp nut

014034

The side handle can be swung 360° on the vertical and secured at any desired position. It also secures at eight different positions back and forth on the horizontal. Just loosen the clamp nut to swing the side handle to a desired position. Then tighten the clamp nut securely.

Side grip

⚠CAUTION:

- Always use the side grip to ensure operating safety when drilling in concrete, masonry, etc.

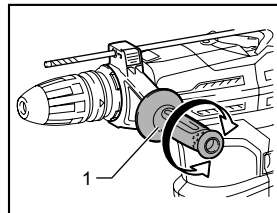

1. Side grip

014027

The side grip swings around to either side, allowing easy handling of the tool in any position. Loosen the side grip by turning it counterclockwise, swing it to the desired position and then tighten it by turning clockwise.

Installing or removing the bit

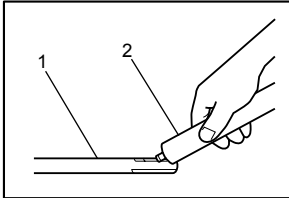

1. Bit shank
2. Bit grease

003150

Clean the bit shank and apply bit grease before installing the bit.

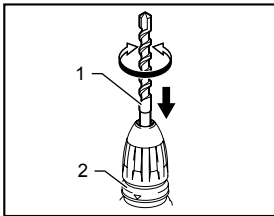

1. Bit
2. Release cover

014878

Insert the bit into the tool. Turn the bit and push it in until it engages.

If the bit cannot be pushed in, remove the bit. Pull the release cover down a couple of times. Then insert the bit again. Turn the bit and push it in until it engages.

After installing, always make sure that the bit is securely held in place by trying to pull it out.

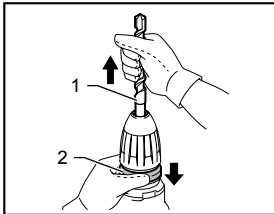

1. Bit
2. Release cover

014879

To remove the bit, pull the release cover down all the way and pull the bit out.

Bit angle (when chipping, scaling or demolishing)

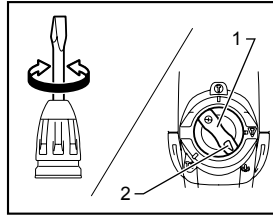

1. Change lever
2. Pointer

014090

The bit can be secured at 24 different angles. To change the bit angle, rotate the change lever so that the pointer points to the symbol. Turn the bit to the desired angle.

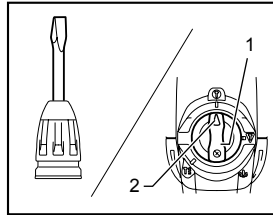

1. Change lever
2. Pointer

014091

Rotate the change lever so that the pointer points to the symbol. Then make sure that the bit is securely held in place by turning it slightly.

Depth gauge

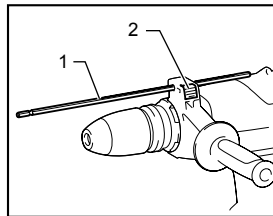

1. Depth gauge
2. Lock button

014033

The depth gauge is convenient for drilling holes of uniform depth.

Press and hold the lock button, and insert the depth gauge into the hex hole.

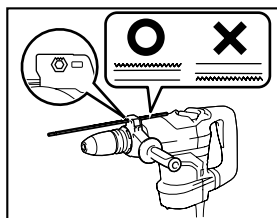

014135

Make sure the toothed side of the depth gauge faces the marking.

Adjust the depth gauge by moving it back and forth while pressing the lock button. After adjustment, release the lock button to lock the depth gauge.

NOTE:

- The depth gauge cannot be used at the position where the depth gauge strikes against the gear housing/motor housing.

OPERATION

⚠CAUTION:

- Make sure the work material is secured and not unstable. Flown object may cause personal injury.
- Do not pull the tool out forcibly even the bit gets stuck. Loss of control may cause injury.

Hammer drilling operation

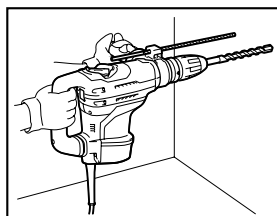

014030

Set the change lever to the  symbol.

Position the bit at the desired location for the hole, then pull the switch trigger.

Do not force the tool. Light pressure gives best results. Keep the tool in position and prevent it from slipping away from the hole.

Do not apply more pressure when the hole becomes clogged with chips or particles. Instead, run the tool at an idle, then remove the bit partially from the hole. By repeating this several times, the hole will be cleaned out and you can continue drilling operation.

⚠CAUTION:

- There is a tremendous and sudden twisting force exerted on the tool/bit at the time of hole breakthrough, when the hole becomes clogged with chips and particles, or when striking reinforcing rods embedded in the concrete. Always use the side grip (auxiliary handle) and firmly hold the tool by both side grip and switch handle during operations, and maintain good balance and safe footing. Failure to do so may result in the loss of control of the tool and potentially severe injury.

Blow-out bulb (optional accessory)

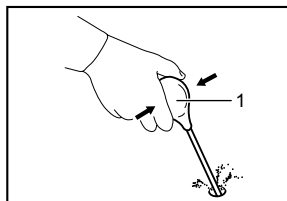



002449

After drilling the hole, use the blow-out bulb to clean the dust out of the hole.

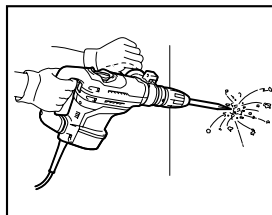
Chipping/Scaling/Demolition



014031

Set the change lever to the  or  symbol.

Hold the tool firmly with both hands. Turn the tool on and apply slight pressure on the tool so that the tool does not bounce around, uncontrolled. Pressing very hard on the tool will not increase the efficiency.

MAINTENANCE

⚠CAUTION:

- Always be sure that the tool is switched off and unplugged before attempting to perform inspection or maintenance.
- Never use gasoline, benzene, thinner, alcohol or the like. Discoloration, deformation or cracks may result.

Lubrication

⚠CAUTION:

- This servicing should be performed by Makita Authorized Service Centers only.
- Do not perform lubrication just after the operation, wait until the tool cools down. Otherwise skin burn may result.

This tool requires no hourly or daily lubrication because it has a grease-packed lubrication system. However, it is necessary to replace grease and carbon brushes periodically for tool's long life.

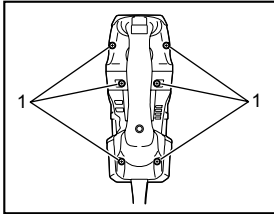

1. Screws

014035

(For model HR4003C, HR5202C) Loosen the six screws and remove the handle.

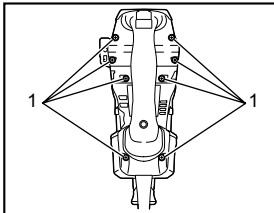

1. Screws

014037

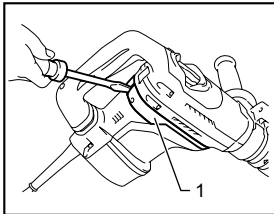

1. Guard cover

014075

(For model HR4013C, HR5212C) Loosen the eight screws. And remove the guard cover as shown in the figure. And then remove the handle.

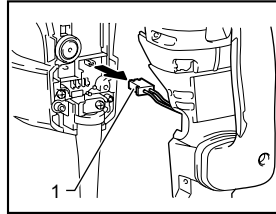

1. Connector

014036

Remove the connector by pulling it.

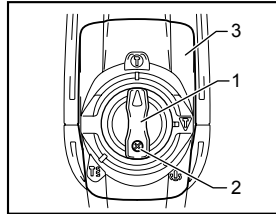

1. Change lever
2. Screw
3. Crank cap cover

014038

Loosen the screws and remove the change lever. Remove the crank cap cover.

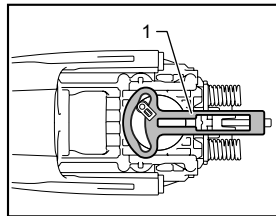

1. Control plate

014039

Remove the control plate.

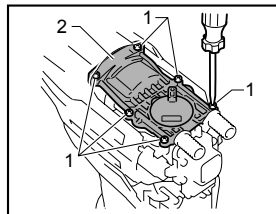

1. Screws
2. Crank cap

014092

Loosen the six screws and remove the crank cap. Rest the tool on the table with the bit end pointing upwards. This will allow the old grease to collect inside the crank housing.

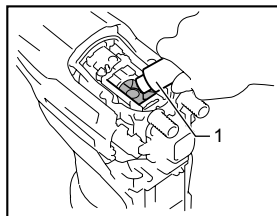

1. Hammer grease

014041

Wipe out the old grease inside and replace with fresh grease:

For model HR4003C, HR4013C: 30g

For model HR5202C, HR5212C: 60g

Use only Makita genuine hammer grease (optional accessory). Filling with more than the specified amount of grease can cause faulty hammering action or tool failure. Fill only with the specified amount of grease. Reinstall all removed parts.

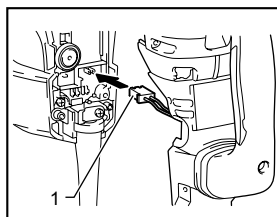

1. Connector

014042

Attach the connector and reinstall the handle.

NOTE:

Note that the different lengths of screws are used.

NOTICE

- Do not tighten the crank cap excessively. It is made of resin and is subject to breakage.
- Be careful not to damage the connector or lead wires especially when wiping out the old grease or installing the handle.

To maintain product SAFETY and RELIABILITY, repairs, any other maintenance or adjustment should be performed by Makita Authorized Service Centers, always using Makita replacement parts.

OPTIONAL ACCESSORIES

⚠CAUTION:

- These accessories or attachments are recommended for use with your Makita tool specified in this manual. The use of any other accessories or attachments might present a risk of injury to persons. Only use accessory or attachment for its stated purpose.

If you need any assistance for more details regarding these accessories, ask your local Makita Service Center.

- SDS-MAX Carbide-tipped bits
- SDS-MAX bull point
- SDS-MAX cold chisel
- SDS-MAX scaling chisel
- SDS-MAX clay spade
- Hammer grease
- Bit grease
- Side handle
- Side grip
- Depth gauge
- Blow-out bulb
- Safety goggles
- Carrying case
- Dust extractor attachment

NOTE:

- Some items in the list may be included in the tool package as standard accessories. They may differ from country to country.