

TOTO

Instruction Manual

WASHLET



washlèt

C200 SW2044
(TCF6531U)

SW2043
(TCF6530U)

A200 SW2024
(TCF6501U)

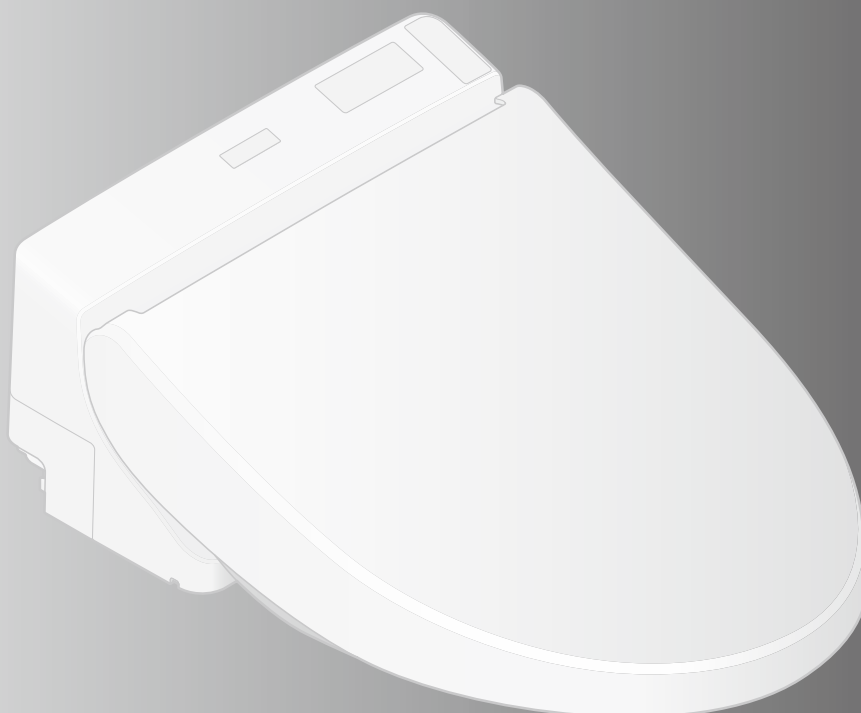

■ Thank you for your recent purchase of the product. Please read the enclosed information to ensure the safe use of your product.

■ Be sure to read this Instruction Manual before using your product and keep it in a safe place for future reference.

The available functions vary according to the model.

Check your model name and write a check mark in this field as needed.

Functions		Product name (Model)	C200		A200	Ref. Page
		Part No.	SW2044	SW2043	SW2024	
Your Model						
Basic Functions	Cleansing	Rear cleansing	●	●	●	16
		Rear soft cleansing	●	●	●	
		Front cleansing	●	●	●	
	Changing the washing method	Wand position adjustment	●	●	●	16, 17
		Water pressure adjustment	●	●	●	
		Oscillating cleansing	●	●	●	
		Pulsating cleansing	●	●	●	
		Personal setting lock	●	●	●	
	Drying	Warm air drying	●	●	—	16
Changing the temperature	Temperature adjustment	●	●	●	22, 23	
Sanitary Functions	Removing odors	Deodorizer	●	●	—	20, 21
	Bowl pre-cleaning	Pre-mist	●	●	—	
Convenient Functions	Heating the toilet seat	Heated seat	●	●	●	—
	Saving energy	Energy Saver	●	●	●	24, 25
Maintenance		Main Unit One-touch removal	●	●	●	28
		Removable toilet lid	●	●	●	29
		Wand cleaning	●	●	●	30

Table of Contents

Safety Precautions	4
Operational Precautions.....	11
Parts Names	12
Preparation.....	14

Introduction

Basic Operations	16
Automatic Functions	20
DEODORIZER, PRE-MIST	
Temperature Adjustment.....	22
Energy Saver Feature	24

Operation

Power Plug	26
Main unit.....	27
Deodorizing Filter	27
Gap between the Main Unit and the Toilet Bowl	28
Gap between the Main Unit and the Toilet Lid	29
Wand	30
Wand cleaning	
Water Filter Drain Valve.....	31

Maintenance

Changing Settings	32
What to Do?.....	38
● If you cannot operate with the remote control	38
● Freeze Damage Prevention ...	38
● Long Periods of Disuse	40
Troubleshooting	41
Specifications	45
Warranty	46

Reference



The self-cleaning functions operate automatically.
(See pages 20 for details.)



As you sit

- A mist is sprayed in the toilet bowl.
- The deodorizer operates.



Safety Precautions

These precautions are important for safe usage. Be sure to follow them and use the product correctly.



Symbols and Meanings

	WARNING	May result in death or serious injury.
	CAUTION	May result in injury or property damage.

The following symbols are used to indicate important safety instructions for the use of the product.

Symbol	Meaning
	This symbol indicates a prohibited use of the product.
	This symbol is used to indicate a required step in the use of this product.

- This product is classified as Class 1 Equipment and must be grounded.
- Install this equipment where the electrical outlet is accessible.
- This appliance is not intended for use by persons (including children) with reduced physical, sensory or mental capabilities, or lack of experience and knowledge, unless they have been given supervision or instruction concerning use of the appliance by a person responsible for their safety.
Children should be supervised to ensure that they do not play with the appliance.
- Use the new hose set included with this equipment. Do not reuse an old hose set.

 WARNING	
	Do not plug or unplug the power plug with wet hands. • Doing so may cause electrical shock.
	Do not get any water or cleaning solution on the main unit or power plug. • Doing so may cause fire, electrical shock, heat or short circuit. • Doing so may cause the product to crack resulting in injury or water damage.
	Never disassemble, repair or alter. • Doing so may cause fire, electrical shock, heat or short circuit.
	Do not install the product on moving vehicles such as wheeled vehicles or boats. • Doing so may cause fire, electric shock, short circuit or malfunction. • The toilet seat, toilet lid, main unit or other parts may come loose and fall off, resulting in injury.

WARNING

Do not use the Washlet if a malfunction occurs.

Always unplug the plug from the outlet.

- Close the water shutoff valve to stop water supply.

Possible malfunctions:

- Water is leaking from a pipe or the main unit.
 - The product is cracked or broken.
 - The product makes a strange noise or emits a strange odor.
 - The product emits smoke.
 - The product is abnormally hot.
 - The toilet seat cushion is out of place.
- Continued use after malfunction could cause a fire, electric shock, heat, short circuit, injury or water damage.

Only use tap water or potable well water (underground water).

Do not use seawater.

- Doing so may cause irritation to the skin and malfunction.

Do not touch the power plug during thunderstorms.

- Doing so may cause electrical shock.

Do not allow the water supply hose to touch the power plug or outlet.

- Doing so may cause condensation resulting in a fire, electrical shock, heat or a short.

Do not do anything that may damage the power cord, power plug.

Do not strike, yank, twist, excessively bend, damage, alter, or heat the electrical cords. Also, do not place anything heavy on, bind or pinch the electrical cords.

- Using a damaged electrical cord may result in a fire, electrical shock, heat or short.

Do not use a loose or faulty electrical outlet.

- Doing so may cause fire or short circuit.

Do no use any outlet or wiring equipment beyond its specified rating.

- Plugging too many plugs into the same outlet, for example using outlet splitters, can cause fire due to heat.

Do not use any power supply other than the one specified.

AC 120V,60Hz

- Doing so may cause fire or excessive heat.

Do not stick a finger or anything else into the warm air outlet.*

Do not place anything on the warm air outlet or drape clothes over it.

- Doing so may cause burns, electrical shock or malfunction.

Keep cigarettes and other open flames away from the product.

- Failure to do so may cause fire.



* Except SW2024

Safety Precautions (Continued)

WARNING

Beware of irritation or burn.

- Improper use of the toilet seat may cause irritation or burn.

When sitting for a long time on the toilet seat, switch the toilet seat temperature adjustment to "OFF". When any of the following persons use a heated seat or warm air drying, someone should switch the toilet seat temperature adjustment to "OFF" and switch the drying air temperature to "Low".

- Young children, the aged and other users unable to set the temperature appropriately themselves.
- The ill, physically disabled and others who do not have freedom of movement.
- Those using any medicines that cause drowsiness (sleeping or cold medicine), those who have been drinking heavily, anyone severely fatigued and anyone else liable to fall asleep.

This is an electrical product. Do not install it anywhere water is likely to get on the product or anywhere with humidity high enough that water is likely to form on the surface of this product. When using the product in a bathroom, install a fan or ventilation port and ensure good air flow through the bathroom.

- Failure to do so may cause fire or electrical shock.

Always connect the Washlet to the cold water supply.

- Connecting to hot water supply may result in burns and equipment damage.

Make sure that a properly grounded (3 prong) outlet has been installed.

- Failure to install a grounded outlet could cause electrical shock in the event of a malfunction or short circuit.



Insert the power plug securely into the outlet.

- Failure to do so may cause fire, heat or short circuit.

To unplug, hold the plug, not the cord.

Do not unplug by pulling the cord.

- Pulling on the cord may cause damage and result in fire or heat.

If the electric cord is damaged, avoid danger by having the manufacturer's repair department or equivalent specialist replace it.

Always disconnect the power plug from the outlet before cleaning, maintenance or inspection.

- Failure to do so may cause electrical shock or malfunction.
* Except when using "Wand cleaning".

Periodically remove dust and dirt from the electrical plug and make sure it is securely plugged into the wall outlet.

- Failure to do so may cause fire, heat or short circuit.
Pull the plug out from the outlet and wipe clean with a dry cloth.

Always unplug the plug from the outlet before removing the main unit.

- Failure to do so could cause a fire or electrical shock.

WARNING



Preliminary studies in females suggest that overuse of continuous spraying can increase the possibility of vaginal mucosa drying and potential reduction in desirable microbial organisms.

Although these studies have not been validated, please consult your healthcare provider for concerns regarding whether these circumstances may apply to you.

More importantly, if you are an individual suffering from any immune deficiency as a result of disease, chemotherapy, or other medical condition compromising the immune system you should consult your healthcare provider before use of this product.

CAUTION



Do not use the product if the main unit is unstable.

- Doing so may cause the main unit to come loose and fall, resulting in injury.

If the product is damaged, do not touch the damaged section.

- Doing so may cause electrical shock or injury.
Replace it immediately.

Do not apply strong force, mechanical shock, step on or stand on the toilet seat, toilet lid or main unit. Also do not place any heavy object on the toilet seat, toilet lid or main unit.

- Doing so may cause cracking or cause the main unit to come loose and fall, resulting in injury.
- Doing so could damage the product and cause injury or water damage.

Do not lift up this product by the toilet seat or lid.

Do not raise the toilet seat or lid while objects are resting on top of the toilet.

- Doing so may cause the main unit to come loose and fall, resulting in injury.

When cleaning or maintaining the plastic parts (main unit etc.) or the water supply hose, use a kitchen cleaner diluted with water. Do not use any of the following.

Toilet cleaner, household cleaner, benzene, paint thinner, powdered cleanser or nylon scrubbing pads.

- These items may damage or crack the plastic and cause injury or malfunction.
- These items could damage the water supply hose and cause a water leak.

Safety Precautions (Continued)

CAUTION



To prevent a sudden water leak, do not remove the water filter drain valve when the shutoff valve is open.

- Doing so will cause water to spurt out.
(Refer to Page 31 for instructions on cleaning the water filter drain valve.)

Do not fold or crush the water supply hose; do not damage by cutting with a sharp object.

- Doing so may cause water leaks.

Do not install the base plate, which is not attached.

- Doing so could cause a fire or damage.



If a water leak should occur, always close the shutoff valve.

When the ambient temperature is likely to drop to 0°C (32°F) or lower, prevent damage to the pipes and hoses due to freezing.

- Frozen water pipes could cause the main unit and the pipes to break, resulting in a water leak.
- Regulate the room temperature to prevent the pipes and hoses from freezing during cold months.
- Drain the water.

When not using the Washlet over an extended period of time, drain the water out of the main unit and the water supply hose after closing the water shutoff valve, and pull the electrical plug from the outlet.

When using the product again, allow the product to refill with water first.

- Otherwise, the water in the tank might become contaminated and cause skin inflammation or other problems. (Refer to Page 39 for instructions on replenishing the water.)
- Leaving the power on may cause fire or heat.

When installing the water filter drain valve, make sure that it is securely tightened in its proper position.

- Failure to securely tighten it may cause a water leaks.

Push the main unit securely on to the base plate.

After pushing the main unit until a click sound is heard, pull it slightly toward you to make sure that the product does not detach.

- Failure to do so could cause the main unit to come loose and fall resulting in injury.

**DANGER** To reduce the risk of electrocution:

1. Do not use while bathing.
2. Do not place or store the product where it can fall or be pulled into a tub or sink.
3. Do not place in or drop into water or other liquid.
4. Do not reach for the product when it has fallen into water. Unplug it immediately.

**WARNING** To reduce the risk of burns, electrocution, fire or injury to persons:

1. Close supervision is necessary when this product is used by, on, or near children or invalids.
2. Use this product only for its intended use as described in this manual. Do not use attachments not recommended by the manufacturer.
3. Never operate this product if it has a damaged cord or plug, is not working properly, has been dropped or damaged, or has been dropped in water. Return the product to a service center for examination and repair.
4. Keep the cord away from heated surfaces.
5. Never block the air openings on the product or place it on a soft surface, such as a bed or couch, where the air openings may be blocked. Keep the air openings free of lint, hair, and other similar items.
6. Never use while sleepy or drowsy.
7. Never drop or insert any object into any opening or hose.
8. Do not use outdoors. Do not operate where aerosol (spray) products are being used or where oxygen is being administered.
9. Connect this product to a properly grounded outlet only.
See "Grounding Instructions" in Page 10.
10. The tank should be filled with water only.

Safety Precautions (Continued)

Grounding Instructions

This product should be grounded. In the event of an electrical short circuit, grounding reduces the risk of electric shock by providing an escape wire for the electrical current.

The plug must be plugged into an outlet that is properly installed and grounded.

 **DANGER** - Improper use of the grounding plug can result in a risk of electric shock.

If repair or replacement of the cord or plug is necessary, do not connect the grounding wire to either flat-head terminal.

Check with a qualified electrician or serviceman if the grounding wire instructions are not completely understood, or if in doubt as to whether the product is properly grounded.

This product is factory equipped with a specific electric cord and plug to permit connection to a proper electric circuit. Make sure that the product is connected to an outlet having the same configuration as the plug.

No adapter should be used with this product. Do not modify the plug provided - if it will not fit in the outlet, have the proper outlet installed by a qualified electrician.

If the product must be reconnected for use on a different type of electric circuit, the reconnection should be made by qualified service personnel.

If it is necessary to use an extension cord, use only a three wire extension cord that has a three blade grounding plug, and a three-slot receptacle outlet that will accept the plug on the product.

Replace or repair a damaged cord.

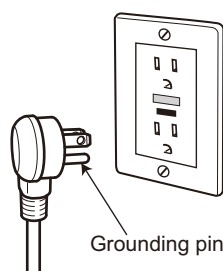

Save these instructions.

Operational Precautions

■ For prevention of malfunctions

- Do not block the remote control transmitter or receiver.

< About the seat switch >

- When you sit on the toilet seat, the seat switch turns ON, enabling you to use various features.
(A click sound is heard when the seat switch is ACTIVATED.)

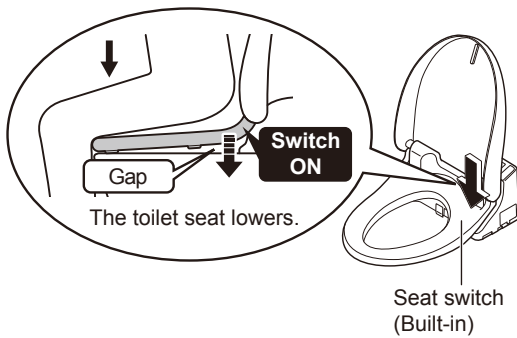

- Sit back on the toilet seat.
 - The seat switch will not turn on unless you sit on the seat properly.



Note

- When a child uses the Washlet, the seat switch may not be ACTIVATED by their light body weight.
- Since the toilet seat is designed to move up and down, a clearance is provided between the toilet seat cushion and the toilet bowl.

■ For prevention of damage

- Wipe plastic areas such as the main unit and remote control with a soft, wet cloth.
- Do not lean against the toilet lid.



■ Problem Prevention

- Disconnect the power plug if there is a risk of lightning.
- A toilet seat cover or a toilet lid cover cannot be used.
(The seat switch may not function properly.)



- Do not urinate on the main unit, toilet seat or wand.
(Doing so may cause pink or brown stains or a malfunction.)
- Do not apply strong forces to the control panel of the remote control.
- When using a toilet cleaner to clean the toilet, wash it off within 3 minutes and leave the toilet seat and toilet lid open. Wipe off any cleaner that remains on the toilet bowl.
(If vapor from a toilet bowl cleaner enters the main unit, it may cause a malfunction.)
- Do not expose to direct sunlight.
(Doing so may cause changes in color, irregular heated seat temperature, remote control malfunction or Washlet malfunction due to the change in temperature.)
- Use radios, etc. away from the Washlet.
(The Washlet could cause interference with the radio signal.)
- If you use a booster seat for infants or a soft highchair, remove it after use.
(Keeping it installed may prevent some of the functions from being used.)
- Do not apply force to the remote control.
(May cause malfunction.)
To prevent the remote control from being dropped, set it in the hanger when you are not using it. Be careful not to expose it to water.
- Do not place anything on the toilet seat and lid, and do not press them with hands.
Failure to do so may turn on the seat switch, causing the floor to get wet if buttons on the remote control are touched and warm water comes out from the wand. (The seat switch may turn on if force is applied to the toilet seat or lid.)

Parts Names

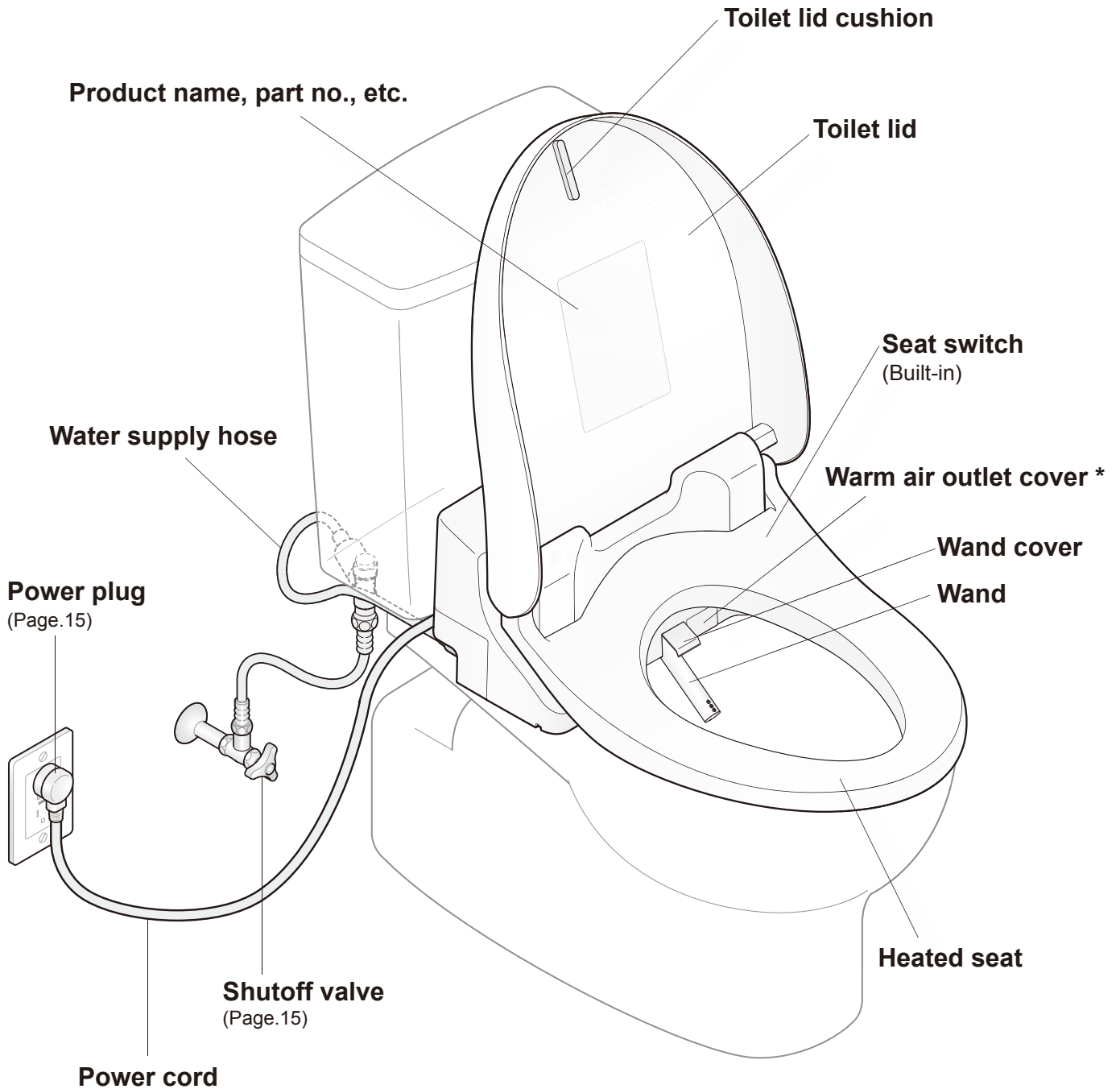

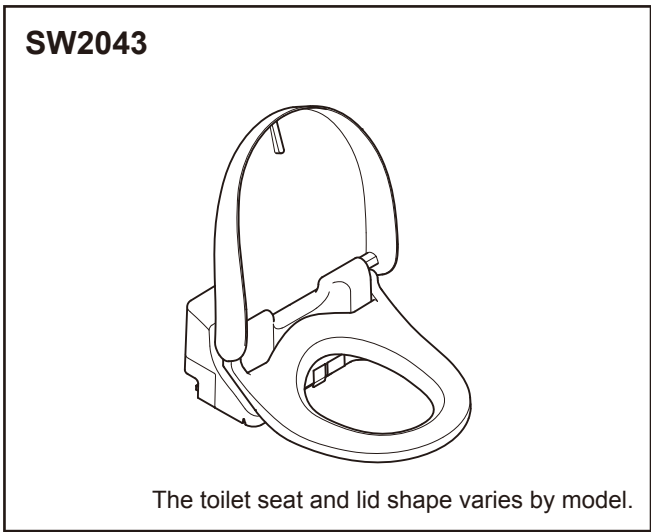
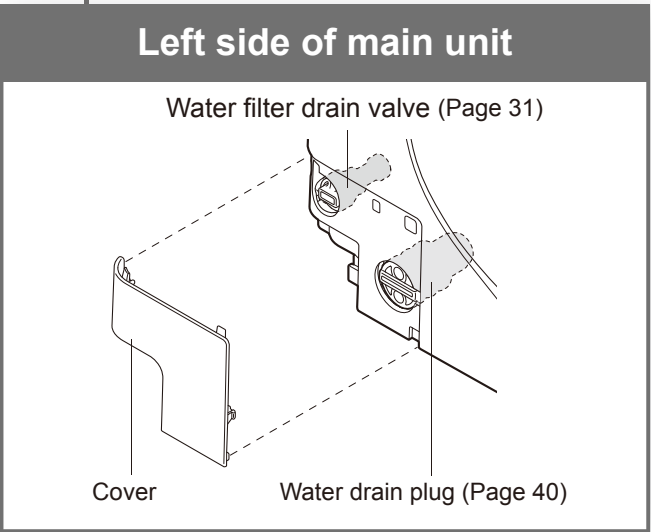
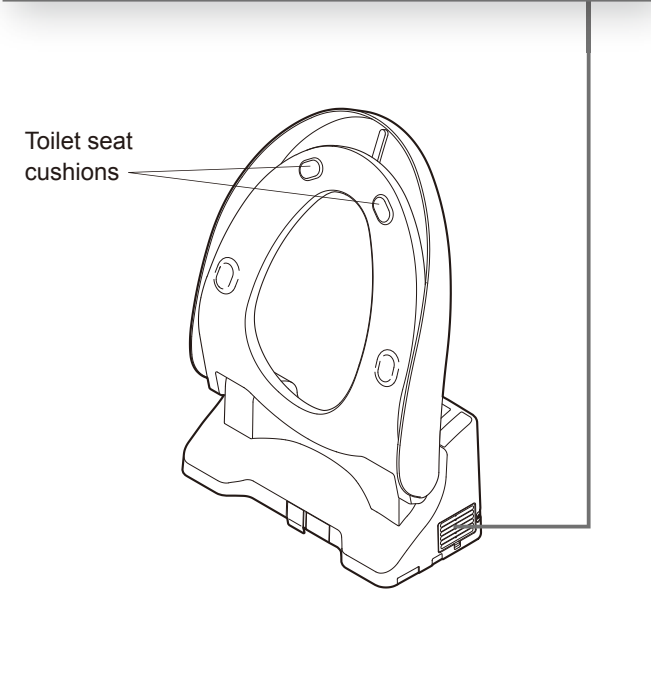
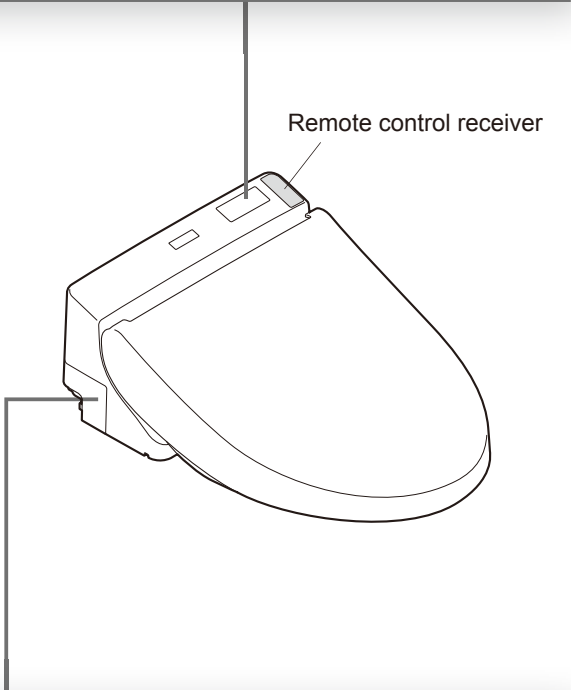
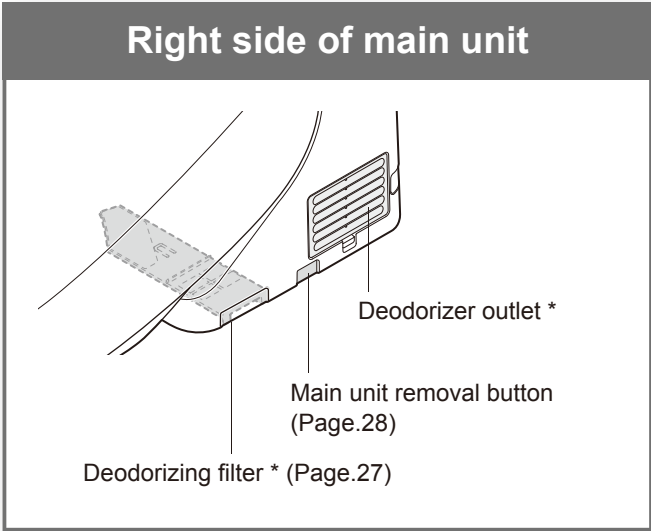
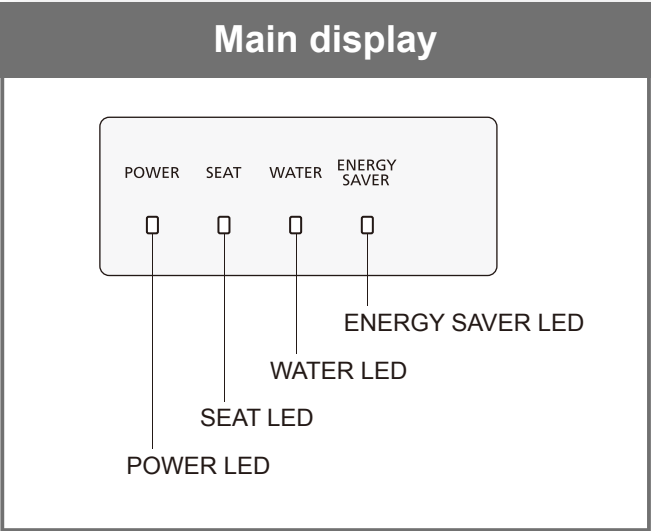

* Except SW2024

Descriptions in this manual are based on the illustrations of SW2044.

Preparation

Using the Product for the First Time

1. Insert the battery

- 1 Remove the remote control from the hanger.

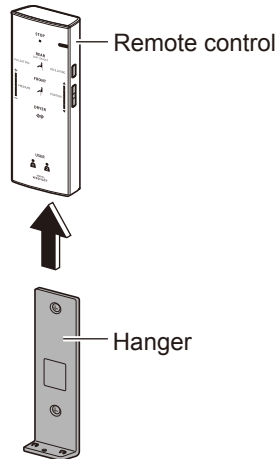

- 2 Open the battery cover and insert two AA batteries.

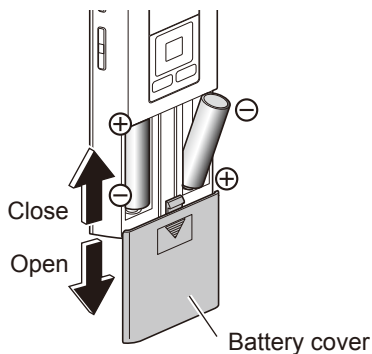

- When batteries are properly inserted, temperature levels appear on the display of the remote control (back side).
- The display goes out when no button on the remote control is pressed for 5 minute or more.

- 3 Mount the remote control in the hanger.

■ About the batteries

- Use dry cell, alkaline batteries. Follow the instructions below to prevent the batteries from rupturing or leaking fluid.
- When replacing the batteries, use new batteries of the same brand.
- If you will not be using the remote control for a long time, remove the batteries.
- Do not use rechargeable batteries.

If the remote control is secured (for anti theft)

- 1 Remove the screw from the remote control fixture.

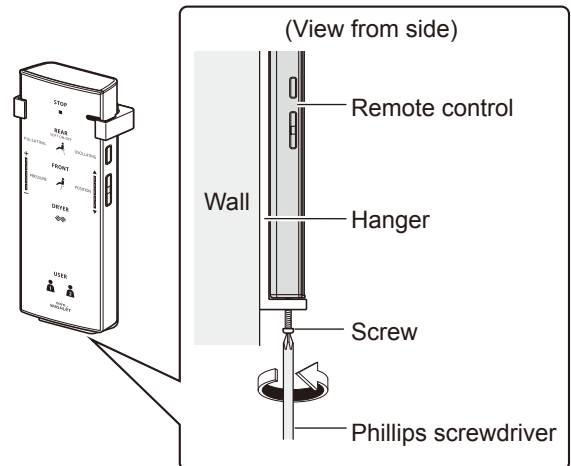

- 2 Remove the remote control from the hanger.

- To secure the remote control again
Tighten the screw.
(Overtightening may cause damage to parts such as the hanger)

2. Turn on the power

- 1 Insert the power plug.
 - The wand extends and then retracts.

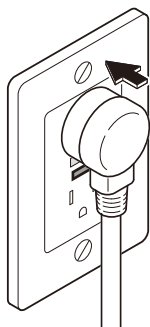

- 2 Check that the POWER LED on the main display is lit up.

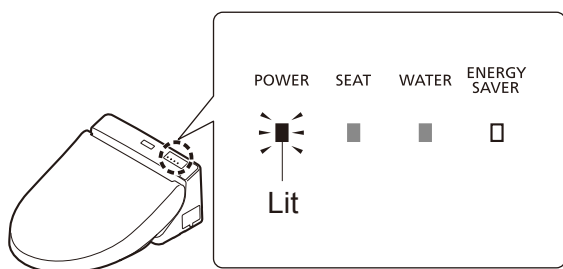

3. Open the shutoff valve

- 1 Fully open the shutoff valve.

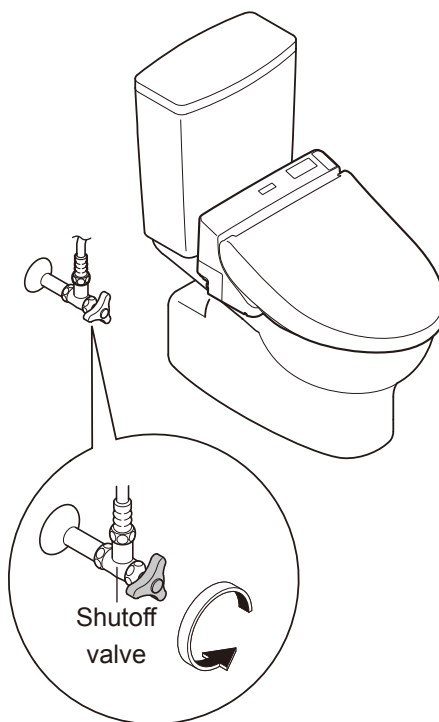

Basic Operations

Press a button on the remote control; a beep sounds when the main unit receives the signal.

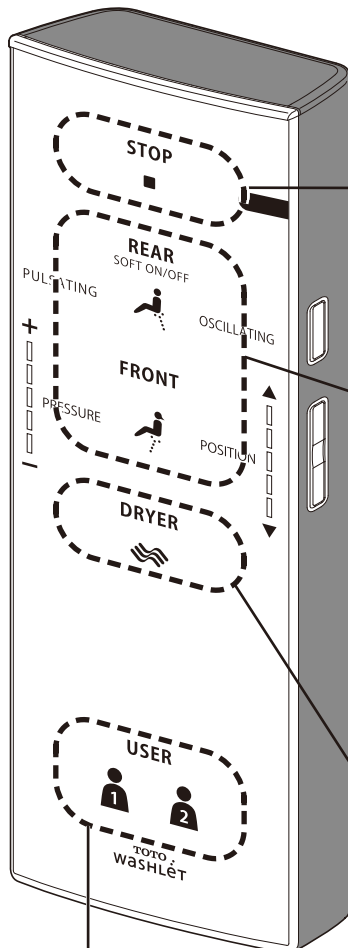

(The drawing is SW2044)

Stopping

[STOP]
Stops the operation.

Cleansing

[REAR]
Cleanses your rear.



[SOFT]
Washes your rear with mild water pressure.

*The mode changes between [SOFT] (Flickering) and [REAR] (Lit) each time the button is pressed.

[FRONT]
Serves as a bidet for ladies.



Drying (SW2044, SW2043 only)

[DRYER]
Dries your rear.



Personal Setting



[USER1] / [USER2]

You can store your preferred wand position, water pressure and water temperature a setting.

- To store a setting

While cleansing is in progress, set your preferred wand position, water pressure, and warm water temperature, and then press and hold [USER 1] or [USER 2] for 2 seconds or longer.

- To use

Press [USER 1] or [USER 2], and then press the button for the cleansing you want to use.

*The wand position and water pressure lamps will light up for about 10 seconds in their set positions, and the water temperature display switches.

- Functions that operate when a button is pressed during "REAR", "SOFT", or "FRONT" cleansing.

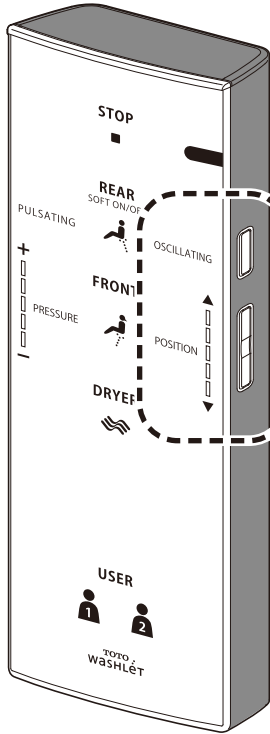

[OSCILLATING]

- The wand moves back and forth to wash your rear thoroughly.
- The setting changes between "ON" and "OFF" each time the button is pressed.

[POSITION]

- The wand position can be adjusted to the front or rear.
- ("▲": Moves to the front, "▼": Moves to the rear)

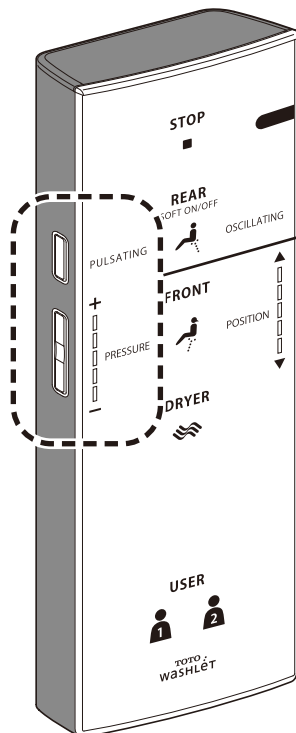

[PULSATING]

- Washes with the water pressure pulsating between soft and strong.
- The setting changes between "ON" and "OFF" each time the button is pressed.

[PRESSURE]

- The water pressure strength can be adjusted for cleansing functions such as REAR. ("-" : Softer, "+" : Stronger)

Note

- Sitting back on the toilet seat makes it easier to adjust the wand position and to reduce splashing.

For your information

- Water may sometimes come out from around the wand when it expands in the warm water tank, but this is normal.
- As the warm water tank of hot-water system is used, the temperature of warm water may become lower if it is continuously consumed.

Basic Operations

About the Menu Screen

This section is an overview of the settings that can be configured with the remote control.

- See the corresponding pages for the detailed descriptions.
- The setting items and numbers vary according to the model.

Remote control back side

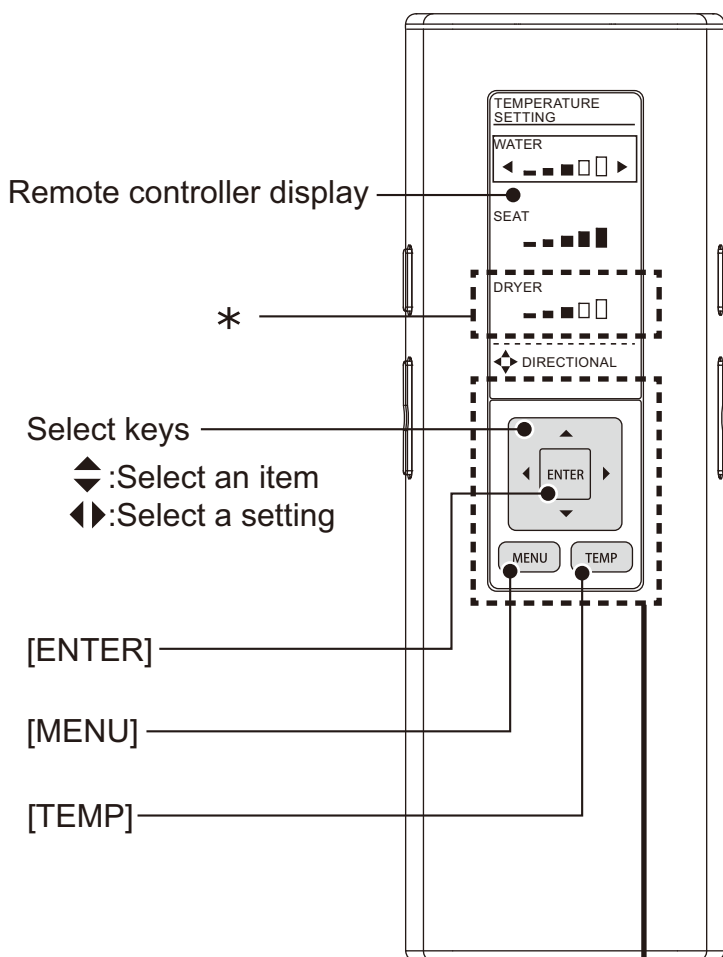

Press [MENU] to display the menu screen.



SETTING LOCK

You can lock the settings so that you do not mistakenly operate the rear buttons while using the remote control.

How to Set (Page 36)

Display screen during setting lock

The diagram shows a rectangular box representing the remote control's display during a setting lock. At the top, it says 'SETTING LOCK' above a padlock icon. Below the icon, it says 'PRESS ENTER FOR 2 SEC TO RESET'.

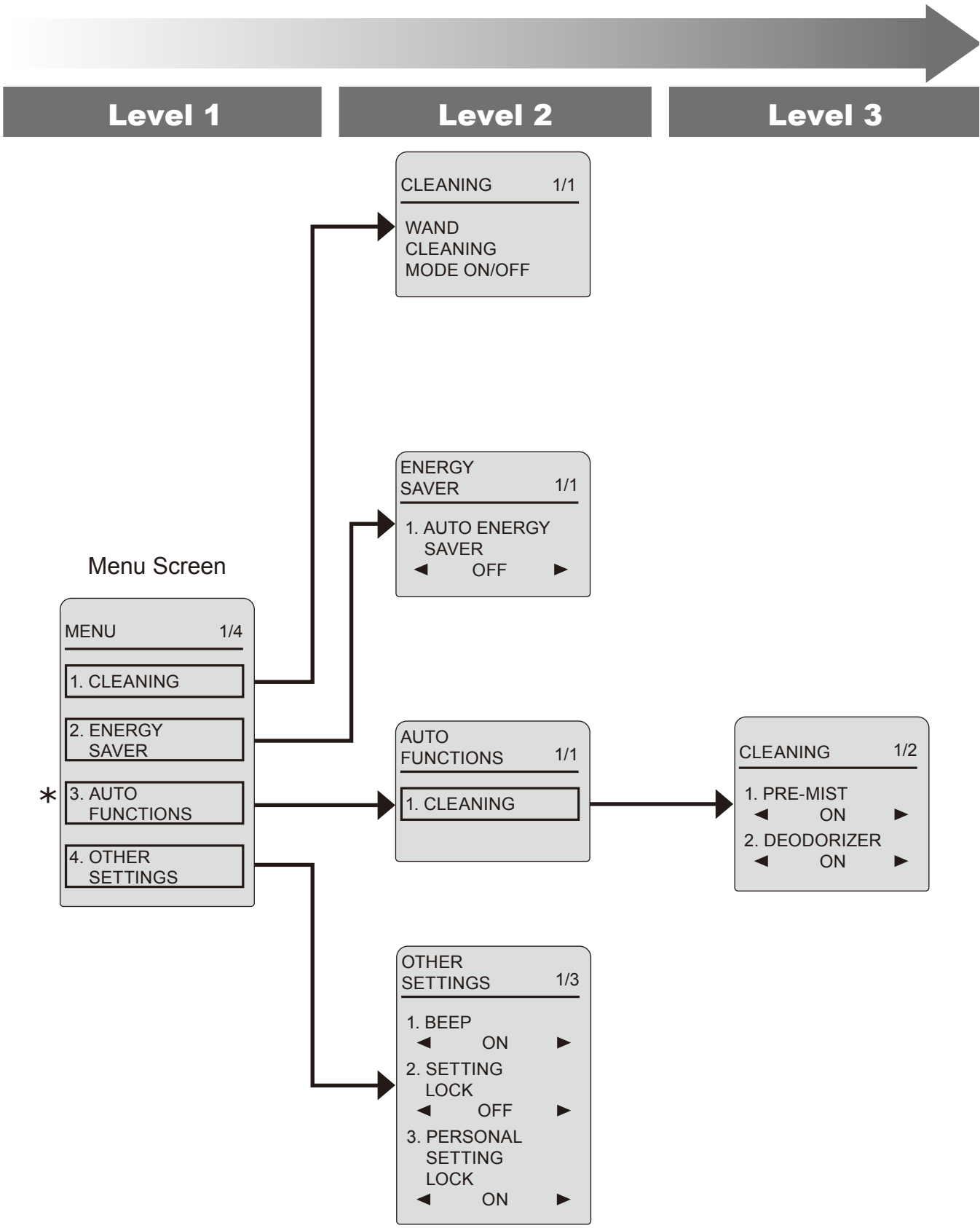

* Will not be displayed on SW2024 remote control.

Automatic Functions

Cleaning Features

As you approach



As you sit



As you stand up*



DEODORIZER
(SW2044, SW2043
only)



Starts the deodorizer

Deodorizer stops
→It stops after about 2 minutes

A mist is sprayed inside the
toilet bowl to make it more
difficult for dirt to adhere

PRE-MIST
(SW2044, SW2043
only)



A mist is sprayed inside
the toilet bowl

* To sanitize the toilet bowl every time it is used, water remaining in the wand is drained after you stand up from the toilet seat.

■ **Note**

■ **Changing settings**

	<ul style="list-style-type: none"> • DEODORIZER ON/OFF (Page 34)
--	---------------------------------------------------------------------------------

<ul style="list-style-type: none"> • The pre-mist will not spray for about 90 seconds after you stand up from the toilet seat. 	<ul style="list-style-type: none"> • PRE-MIST ON/OFF (Page 34)
-----------------------------------------------------------------------------------------------------------------------------------------------	-------------------------------------------------------------------------------

If dirt adheres...

- **If dirt adheres to the wand during use, you can extend the wand to clean it.**
 - Cleaning the wand (Page 30)

Temperature Adjustment

Warm Water / Toilet Seat / Drying *

You can adjust the temperature levels or turn the settings to "OFF".

1  Press [TEMP].

2  Use  to select the item you want to set.

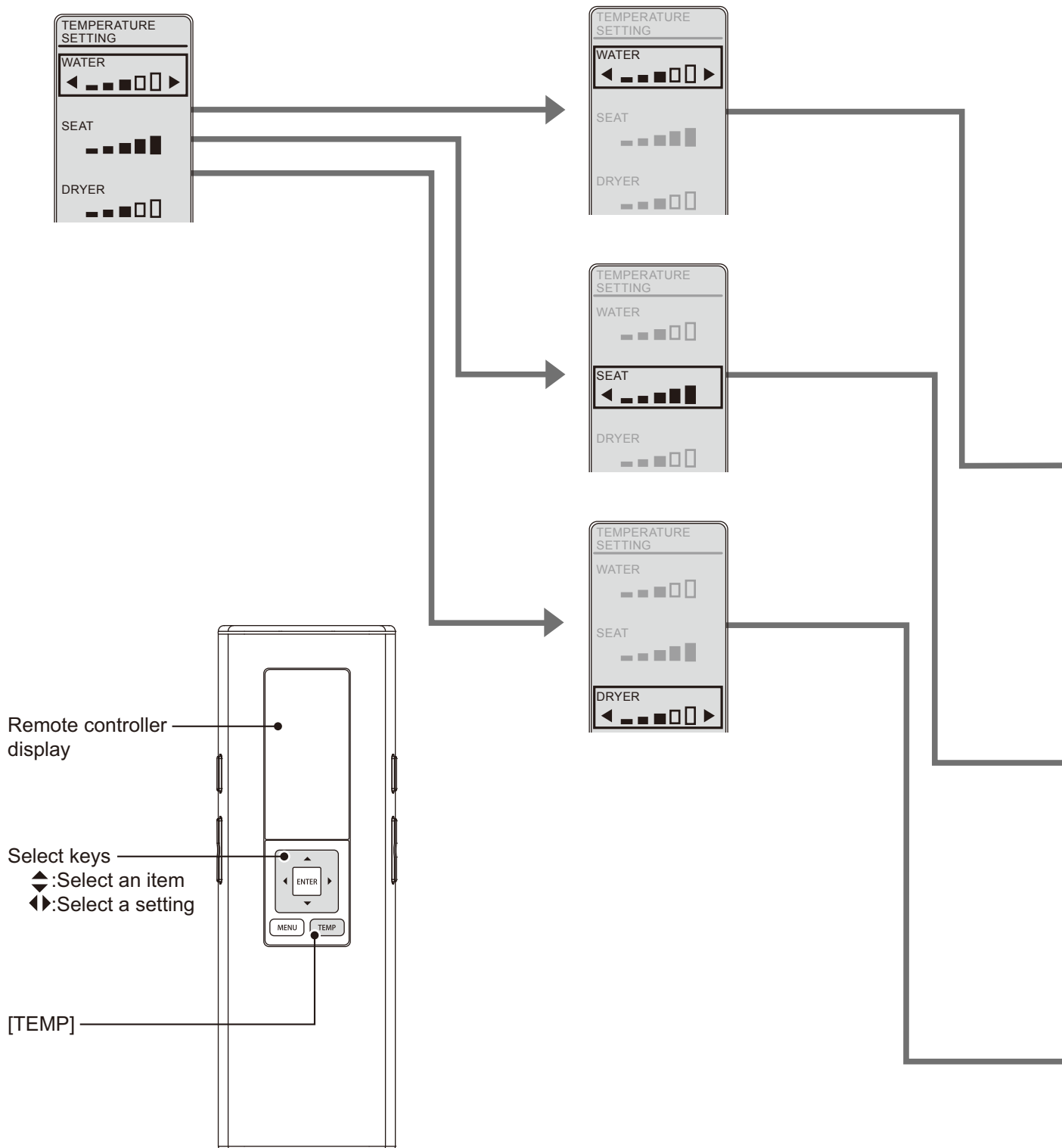

3



Use ◀▶ to select the temperature level. <Settings complete>

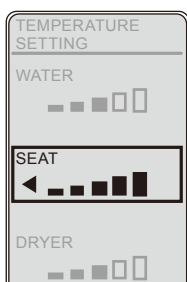

Warm water temperature

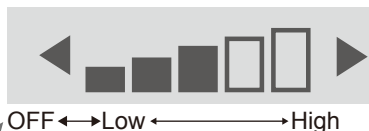

Press ◀ until "OFF" appears.

- When "OFF" is set, the WATER LED will go off.

Toilet seat temperature

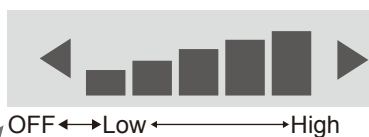

Press ◀ until "OFF" appears.

- When "OFF" is set, the SEAT LED will go off.

Drying air temperature*

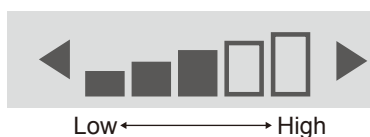

* Will not be displayed on SW2024 remote control.

Energy Saver Feature

You can save energy by turning the toilet seat heater to a low temperature (or turning the heater "OFF") during periods when the toilet will be used infrequently.

- It takes about 10 days for the product to determine the periods when it is used relatively less frequently.

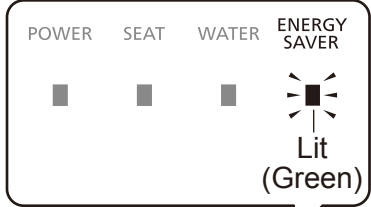
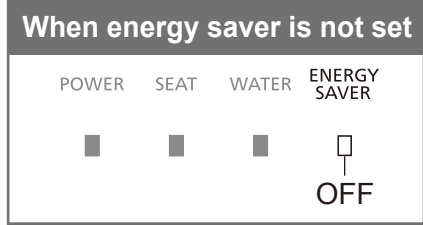
Type	Situation	When energy saver is set	
		Main Display	
ENERGY SAVER	<p>You want the Washlet to save energy automatically</p> <p>The Washlet detects time periods with infrequent use and lowers the toilet seat temperature automatically. Furthermore, it automatically turns off the toilet seat and warm water heater during time periods when the toilet is never used.</p>		→
		<p>When energy saver is not set</p> 	→

Note

- Even if the toilet seat heater is being activated (with the toilet seat heater set to "Low" or "OFF," or with the warm water heater set to "OFF"), the toilet seat will be temporarily heated when you sit on it. (To reach the setting temperature, the toilet seat and warm water take about 15 minutes and 10 minutes, respectively.)

How to set

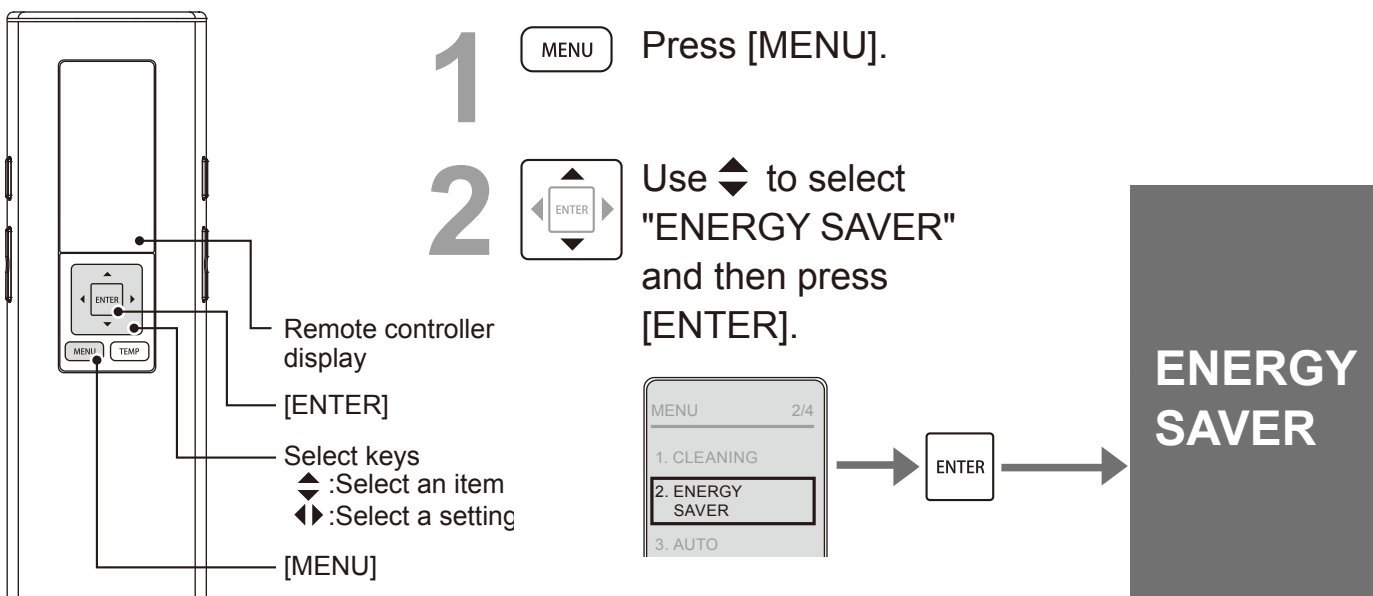

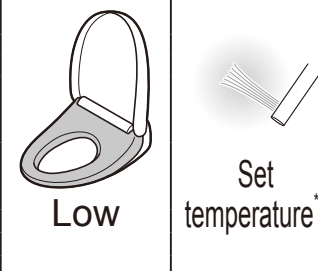
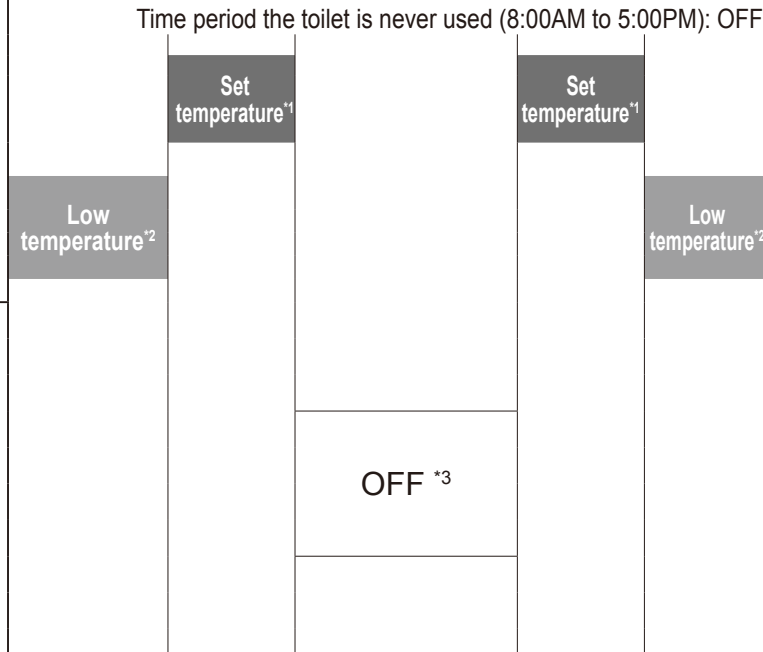
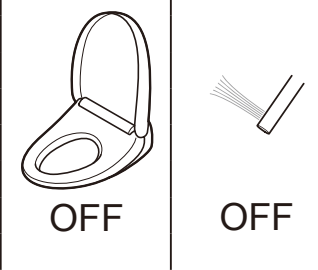
When energy saver is in operation			AM						PM						
	Toilet seat heater	Warm water heater	0	6	8		5	9	0						
<p>Time period with infrequent use</p> <p>POWER SEAT WATER ENERGY SAVER</p> <p>OFF Lit Lit (Orange)</p> 	Low	Set temperature*1	<p>Example) Time period with infrequent use (from 9:00PM to 6:00AM): Low Time period the toilet is never used (8:00AM to 5:00PM): OFF</p> 												
<p>Time period the toilet is never used</p> <p>POWER SEAT WATER ENERGY SAVER</p> <p>OFF OFF Lit (Orange)</p> 	OFF	OFF													

*1 The temperature set on Page 22.

*2 The time period when the toilet seat heater is set to a "low temperature" by the energy saver. The warm water heater is "Set temperature".

*3 The time period when the toilet seat heater and warm water heater are "OFF".

3



Use  to select "AUTO ENERGY SAVER".

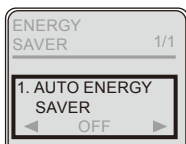

4



Use  to select "ON" or "OFF" and then press [ENTER].

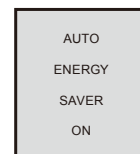
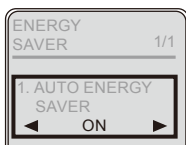

(To return → MENU)

Maintenance

Power plug (Perform monthly)

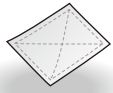

Dry cloth



Wet cloth

- 1** Disconnect the power plug and wipe it with a dry cloth.

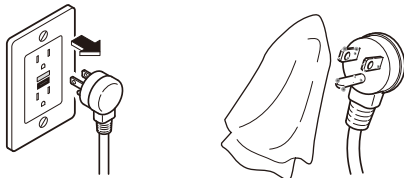

- 2** Insert the power plug.
 - The POWER LED lights up.

WARNING

-  **Periodically remove dust from the blades and other parts of the power plug.**
 - Disconnect the plug and wipe it with a dry cloth.



- **Fully insert the power plug.**
- **When disconnecting, hold the main body of the power plug.**
 - Pulling the cord may damage the plug or cord.

WARNING

-  **Always disconnect the power plug from the outlet before cleaning, maintenance or inspection.** (see left)
(Failure to do so may cause electric shock or malfunction, resulting in a breakdown.)

***For safety, disconnect the power plug before cleaning or maintenance.**

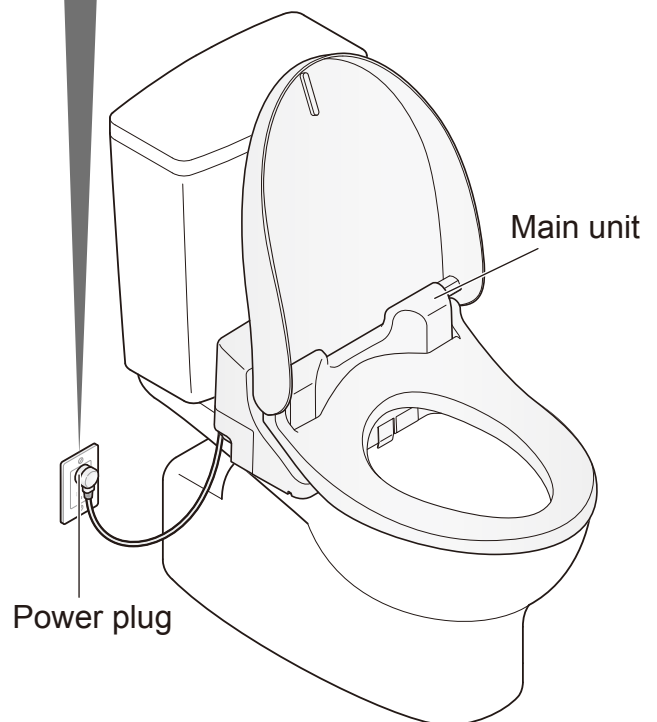

Do not use a dry cloth or toilet paper on plastic parts.
(May cause damage.)



*Except when using "Wand cleaning".

Main Unit (Perform daily)



Soft cloth soaked in water

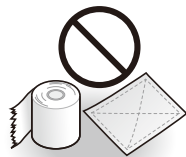

- Toilet paper
- Dry cloth
- Nylon scrubbing pads
(May cause damage.)

1 Unplug the power plug.

2 Wipe with a soft cloth that has been soaked in water and wrung-out thoroughly.

■ For heavy dirt

- Wipe with a soft cloth soaked in diluted, neutral kitchen detergent, and then wipe with a soft cloth soaked in water.

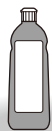

- Neutral kitchen detergent



- Paint thinner
- Benzene
- Powdered cleanser

3 Insert the power plug.

- The POWER LED lights up.

Attention!

- **The Washlet is an electric appliance. Be careful not to let water seep inside or leave detergent in the gap between the main unit and toilet bowl.**
(May damage plastic parts or cause a malfunction.)
- **When using a toilet cleaner to clean the toilet, wash it off within 3 minutes and leave the toilet seat and toilet lid open.**
 - Wipe off any cleaner that remains on the toilet bowl. (If vapor from a toilet bowl cleaner enters the main unit, it may cause a malfunction.)
- **Do not push or pull the covers around the wand with undue force.**
(May cause damage or malfunction.)

Deodorizing filter (Perform monthly)

<If you notice odors> (SW2044, SW2043 only)

1 Unplug the power plug.

2 Remove the deodorizing filter.

- Hold the knob and pull outward.
- Do not pull with undue force.
(May cause damage or malfunctions)

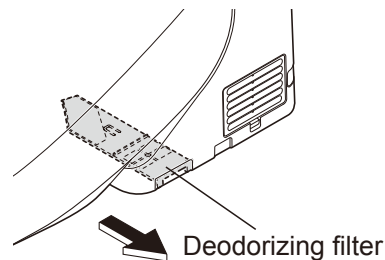

3 Clean with a tool such as a toothbrush.

- When washing with water, dry off all water before mounting.

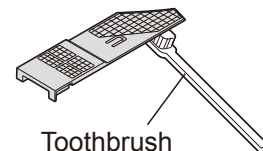

4 Mount the deodorizing filter.

- Push firmly until a click sound is heard.

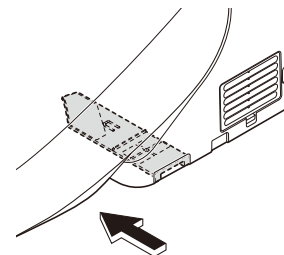

5 Insert the power plug.

- The POWER LED lights up.

Maintenance

Gap between the Main Unit and Toilet Bowl (Perform monthly)

You can remove the main unit to clean the top of the toilet bowl and the bottom of the main unit.



Soft cloth soaked in water

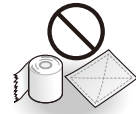

Toilet paper, etc. (May cause damage.)

1 Unplug the power plug.



If the power is not unplugged, the unit may malfunction or cause a failure or electric shock.

2 Remove the main unit.
 • Do not pull the unit with undue force (because the water supply hose and power cord are attached).

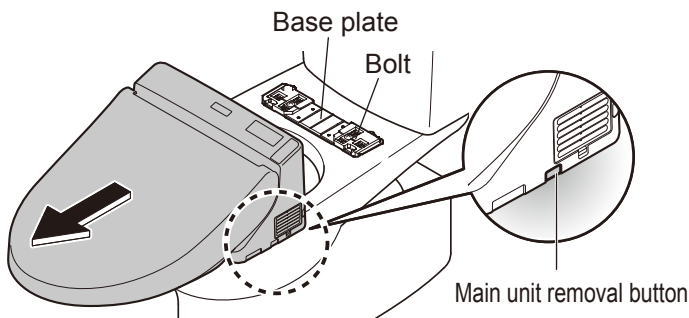

Pull the main unit toward you while pressing the button.

3 Clean the gap.
 • Wipe with a soft cloth soaked in a diluted, neutral kitchen detergent. Then, wipe it with a soft cloth soaked in water so that no detergent remains.

4 Mount the main unit.

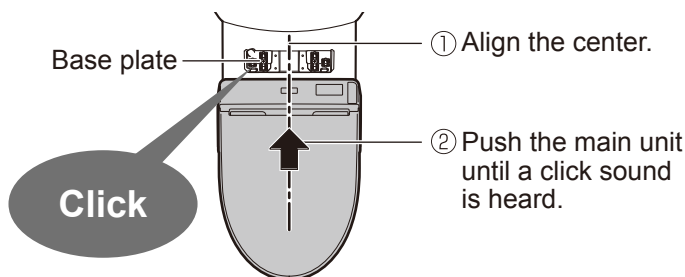

CAUTION

! Push the main unit firmly onto the base plate until a click sound is heard.

After mounting, check that the main unit does not detach even when pulled.

5 Insert the power plug.
 • The POWER LED lights up.

Gap between the Main Unit and the Toilet Lid (Perform monthly)

The toilet lid can be removed for thorough cleaning.



Soft cloth soaked in water



Toilet paper, etc.
(May cause damage.)

1 Unplug the power plug. 

2 Remove the toilet lid.

Ⓐ: Pull the left side outward.
↓
Ⓑ: Disconnect the hinge from the recess and pull up.
↓
Ⓒ: Disconnect the right side.

3 Wipe with a soft cloth that has been soaked in water and wrung-out thoroughly.

4 Reinstall the toilet lid.

Ⓓ: Join the pin and the hinge on the right side.
↓
Slightly tilt the toilet lid to the front.
Ⓐ: While pulling out the left side,
↓
Ⓔ: Mount by joining the hinge with the recess.
* Be careful not to pinch your fingers.

5 Open and close the toilet lid to check the mounting, and then mount the main unit.

6 Insert the power plug.
• The POWER LED lights up.

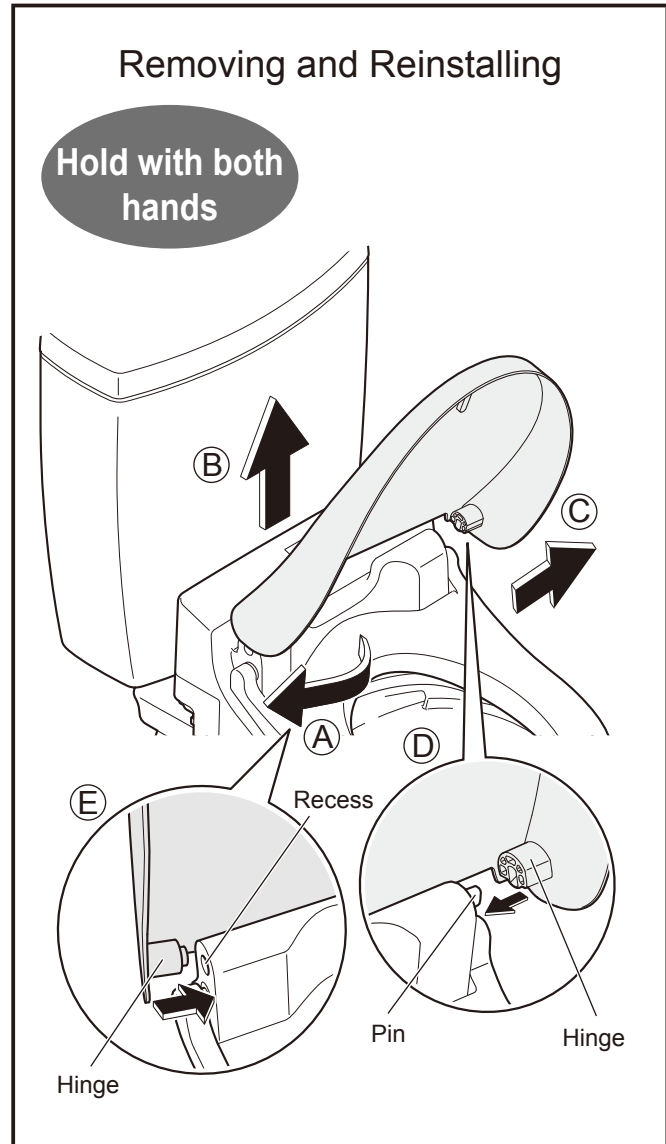

Maintenance

Wand (Perform monthly) <Wand cleaning> If you notice dirt



Soft cloth soaked in water

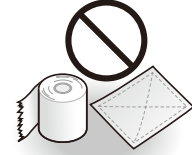

Toilet paper, etc.
(May cause damage.)

1

Extend the wand.

- Operate with the buttons on the back side of the remote control.

(1) Press [MENU].

(2) Use  to select "CLEANING".

Press [ENTER].

(3) Use  to select "WAND CLEANING MODE ON/OFF".

Press [ENTER].

- The wand extends and water sprays out for cleaning.
- The wand automatically retracts after about 5 minutes.

2

Wipe with a soft, wet cloth.

Do not pull, push or press the wand with excessive force. (May cause damage or malfunction.)

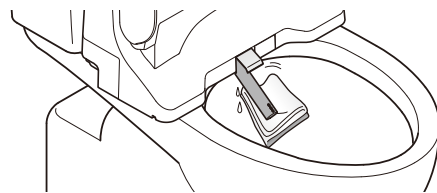

3

Press [STOP] on the front side of the remote control.

- The wand retracts.

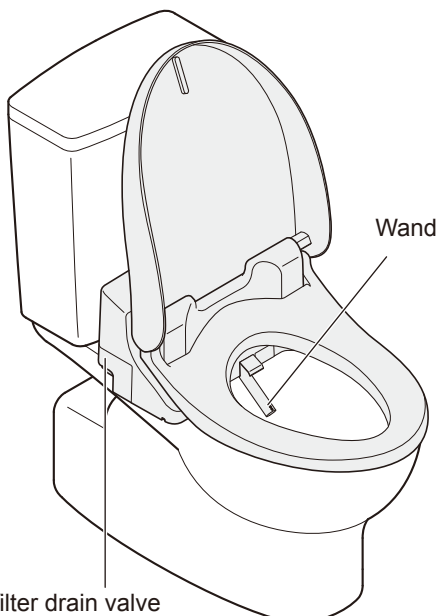
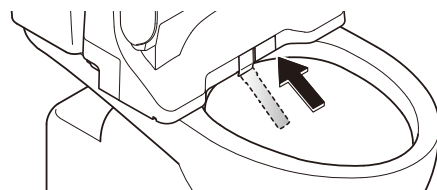

Water filter drain valve (Perform once every 6 months)

<If you think the water pressure has weakened>

- 1** Close the shutoff valve.
• The water supply stops.

CAUTION



Do not remove the water filter drain valve while the shutoff valve is open.
(Otherwise, water may leak out)

- 2** Extend the wand.
• Operate with the buttons on the back side of the remote control.

- (1) Press [MENU].
(2) Use  to select "CLEANING".

Press [ENTER].

- (3) Use  to select "WAND CLEANING MODE ON/OFF".

Press [ENTER] to extend the wand.

Press [ENTER] again to retract the wand.

(Release the pressure from the water supply pipe.)

- 3** Unplug the power plug.

- 4** Remove the cover and water filter drain valve.
• Loosen with a flat-head screwdriver and then pull.

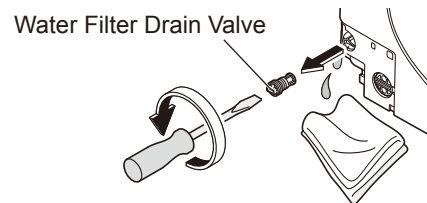
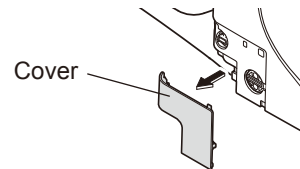

- 5** Clean with a tool such as a toothbrush.
• Also, remove any dust from inside the hole of the water filter drain valve.

- 6** Reinstall the water filter drain valve and cover.
• Insert the water filter drain valve and tighten it securely with a flat-head screwdriver.

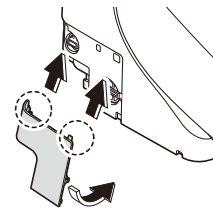

- 7** Insert the power plug.
• The POWER LED lights up.

- 8** Open the shutoff valve.

Changing Settings

Setting List

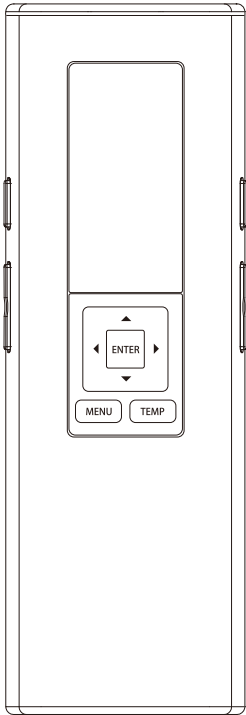

Setting Types		
AUTO FUNCTIONS	CLEANING	PRE-MIST
		DEODORIZER
OTHER SETTINGS	BEEP	
	SETTING LOCK	
	PERSONAL SETTING LOCK	



	Available Settings*	Applicable Models	Setting Ref. Page
<ul style="list-style-type: none"> • Set whether or not to spray mist automatically after sitting on the toilet seat 	ON/OFF	SW2044 SW2043	Page 34
<ul style="list-style-type: none"> • Set whether or not to deodorize automatically after sitting on the toilet seat 	ON/OFF		
<ul style="list-style-type: none"> • Set whether or not to make a beep sound 	ON/OFF	All models	Page 36
<ul style="list-style-type: none"> • Set whether or not to use the setting lock 	ON/OFF	All models	
<ul style="list-style-type: none"> • Set whether or not to use the personal setting lock 	ON/OFF	All models	

*The black text is the initial setting.

Changing Settings

CLEANING

1  Press [MENU].

2  Use  to select "AUTO FUNCTION" and then press [ENTER].

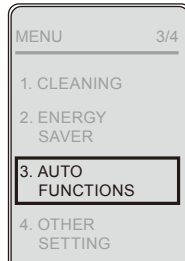

3  Use  to select "CLEANING" and then press [ENTER].

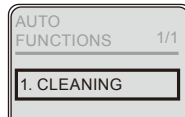

Set whether or not to spray mist automatically after sitting on the toilet seat

PRE-MIST
(SW2044, SW2043 only)

Set whether or not to deodorize automatically after sitting on the toilet seat

DEODORIZER
(SW2044, SW2043 only)

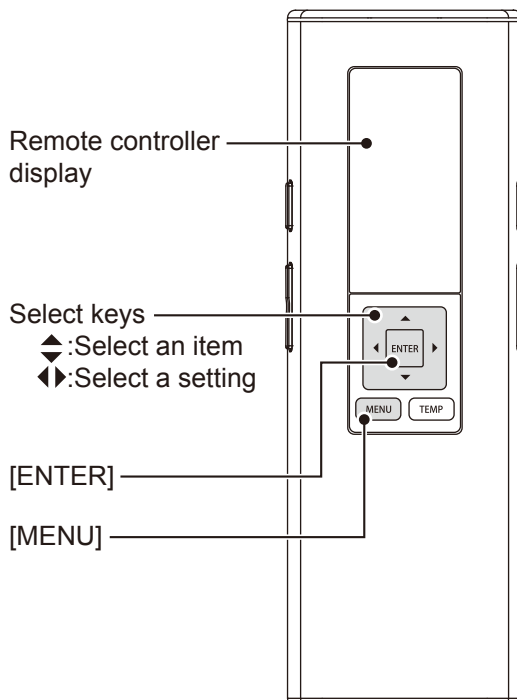

Items set on this display

1. PRE-MIST
2. DEODORIZER*

* Will not be displayed on SW2024 remote control.

4 

Use  to select "PRE-MIST".



5 

Use  to select "ON/OFF" and then press [ENTER].

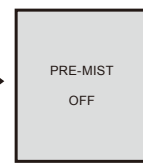

(To return → )

4 

Use  to select "DEODORIZER".



5 

Use  to select "ON/OFF" and then press [ENTER].

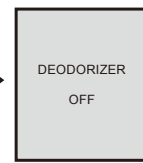



(To return → )

Changing Settings

OTHER SETTINGS

1  Press [MENU].

2  Use  to select "OTHER SETTING" and then press [ENTER].

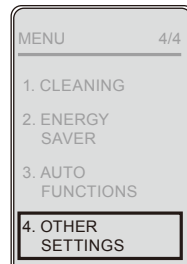

Set whether or not to make a beep sound

BEEP

Set whether or not to use the setting lock

SETTING LOCK

Set whether or not to use the personal setting lock

PERSONAL SETTING LOCK

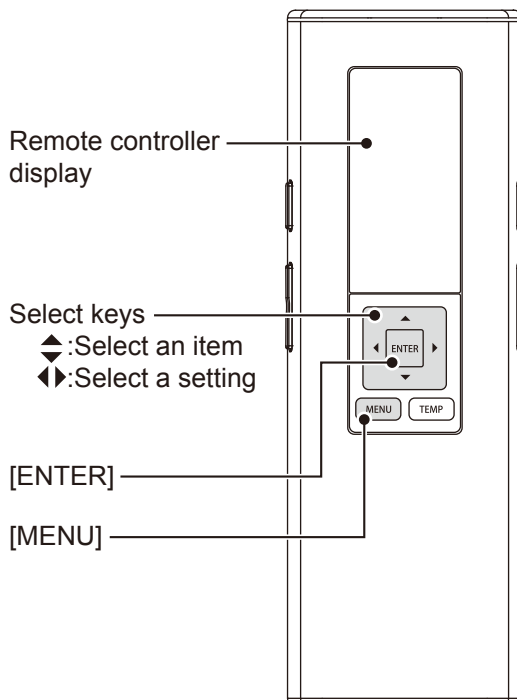

Items set on this display

1. BEEP
2. SETTING LOCK
3. PERSONAL SETTING LOCK

3 Use  to select "BEEP".

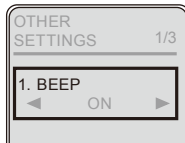

4 Use  to select "ON/OFF" and then press [ENTER].

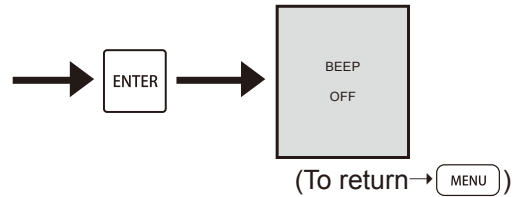
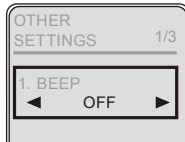

3 Use  to select "SETTING LOCK".



4 Use  to select "ON/OFF" and then press [ENTER].

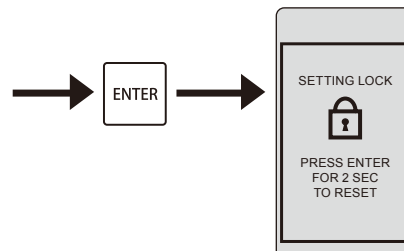

5 Check the displayed screen.





Display screen during setting lock

Cancellation method:
Press [ENTER] for 2 seconds or longer.

*If you want to relock after cancellation, reconfigure the setting.

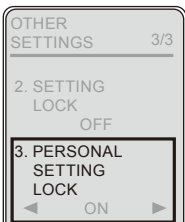
3 Use  to select "PERSONAL SETTING LOCK".



4 Use  to select "ON/OFF" and then press [ENTER].

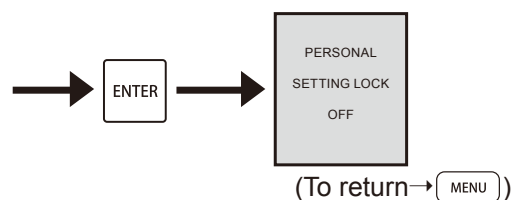
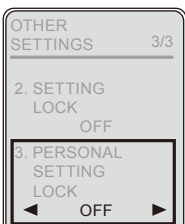

What to Do?

If you cannot operate with the remote control

The batteries may have worn out.
Replace the batteries.

■ Replacing the batteries

- 1** Unplug the power plug.
 - The POWER LED goes off.
- 2** Remove the remote control from the hanger.
(Page14)
- 3** Open the battery cover and replace the AA batteries.
(Page14)
- 4** Mount the remote control in the hanger.
- 5** Insert the power plug.
 - The POWER LED lights up.

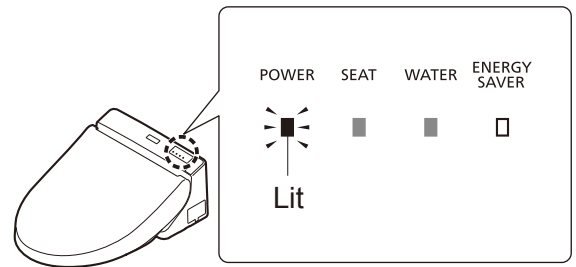

Freeze Damage Prevention

When the ambient temperature is likely to drop to 0°C (32°F) or lower, take measures to prevent freezing.

Attention!

- When the ambient temperature is likely to drop to 0°C (32°F) or lower, do not use the energy saver feature. (May damage the product.)
- Warm the bathroom or take measures against freezing so that the ambient temperature does not drop below 0°C (32°F).

Freeze damage prevention

■ How to drain the water

- 1** Close the shutoff valve.

 **CAUTION**

 Do not remove the water filter drain valve while the shutoff valve is open.
(Otherwise, water may leak out)

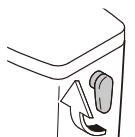

- 2** Drain the water from the toilet tank.

- Turn the flush handle of the toilet tank to the full flush side.
- Turn the lever until water flow stops.



Freeze damage prevention (continued)

3 Drain the pipe.

- (1) Extend the wand.
 - Operate with the buttons on the back side of the remote control.
 1. Press [MENU].
 2. Use  to select "CLEANING".
Press [ENTER].
 3. Use  to select "WAND CLEANING MODE ON/OFF".
Press [ENTER] to extend the wand.
 - Hold the wand in the extended position until no more water comes from around the wand.
 Press [ENTER] again to retract the wand.
(Release the pressure from the water supply pipe.)

- (2) Unplug the power plug.
- (3) Remove the cover and water filter drain valve.

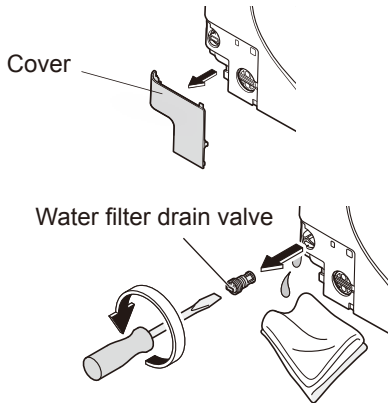

- (4) Drain the water from the water supply hose.

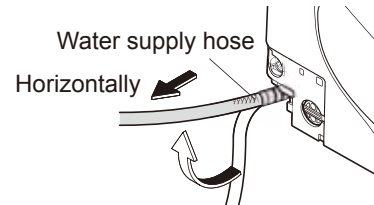

- (5) After draining the water, install the water filter drain valve and cover.
 - Insert the water filter drain valve and use a flat-head screwdriver to tighten it securely.

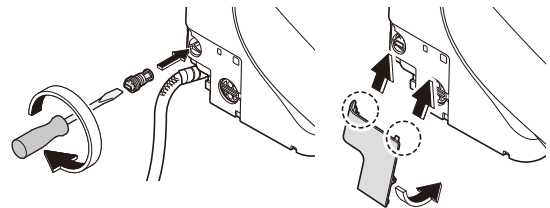

- (6) Insert the power plug.

4 Check that the POWER LED on the main display is lit up.

(Page 15)

5 Set the water and toilet seat temperature to "High". (Page 22)

(To maintain the temperature.)

- When finished, close the toilet seat and toilet lid.

■ To use the Washlet again

- The water needs to be resupplied. (See below)

Resupplying the Water (After draining)

- 1 Open the shutoff valve.
 - Check that water is not leaking from a pipe or the main unit.
- 2 If the power is not turned ON
Insert the power plug.
- 3 Discharge water from the wand.
 - (1) Pressing down the right side of the toilet seat,
 - (2) Press [REAR] on the remote control for about two minutes to discharge water from the wand.
(It takes about one minute before water comes out. Catch the water in a paper cup or other receptacle.)

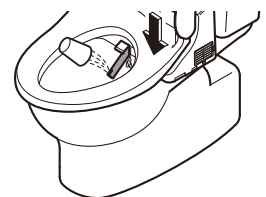

■ If the remaining water has frozen and no water comes out

- Heat the inside of the bathroom, and warm the water supply hose and shutoff valve using a cloth soaked in warm water.

What to Do?

Long Periods of Disuse

If the toilet is in a location you will not visit for a long time, drain the water.

(The water in the tank may become contaminated and cause skin irritation or other problems.)

How to drain the water

1 Drain the water from the toilet tank.
(Procedures **1** and **2** in "Freeze damage prevention" on page 38)

2 Drain the pipe.
(Step **3** (1) to (5) on Page 39)

*After draining water, keep the cover removed.

3 Remove the water drain plug.

- The water comes out from near the wand for about 90 seconds.

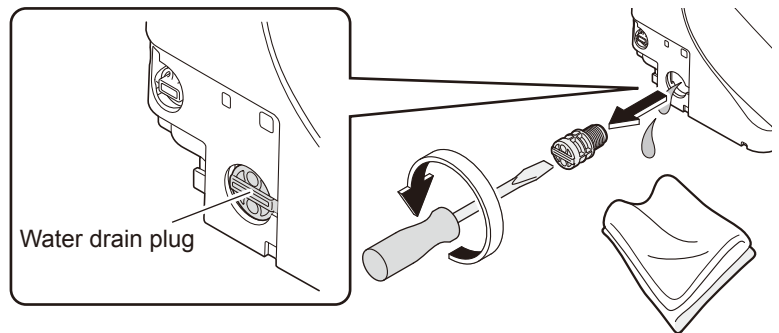

4 Reinstall the water drain plug and cover.

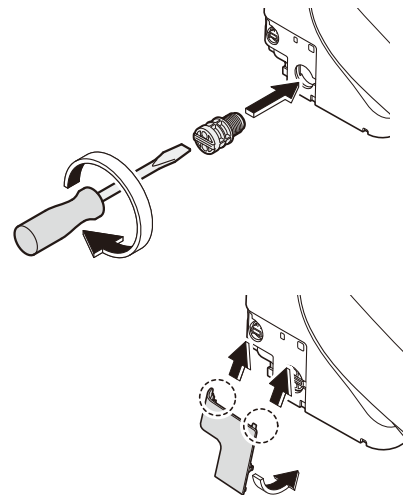

■ If water may get frozen

- Add antifreeze solution in the water in the bowl to prevent freezing.
(The antifreeze solution should not be flushed out. Collect it before using the toilet and dispose of it.)

■ To use the Washlet again

- The water needs to be resupplied. (Page 39)

Troubleshooting

First, try the actions described on pages 41 to 44. If the problem persists, consult the installer, seller or the contact listed on the back cover of this manual.

⚠ CAUTION

! If a water leak occurs, close the shutoff valve.

Please check first

Is the POWER LED lit?

- **SW2044-SW2043**
Is the POWER LED flickering?
→ The main unit is not mounted properly. Mount the main unit again. (Page 28)
- **Is the breaker on the distribution board turned on?**
→ Check whether there is a power outage or the breaker has turned "OFF".

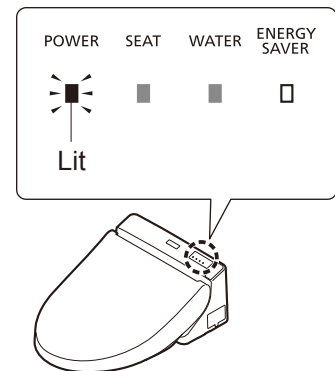

Is the ENERGY SAVER LED lit?

- **While the LED is lit, energy saver (Page 24) is in operation, so the toilet seat temperature may be reduced or the heater may be turned off.**

Is the remote control working?

- **Are the remote control batteries dead?**
→ Replace the batteries. (Page 38)
- **Is the remote control transmitter or the remote control receiver blocked?**
→ Remove obstructions, dirt, water droplets or any other blockages.

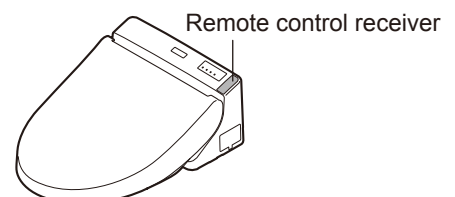
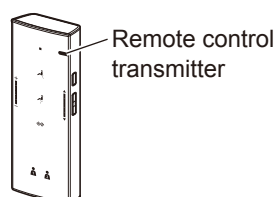
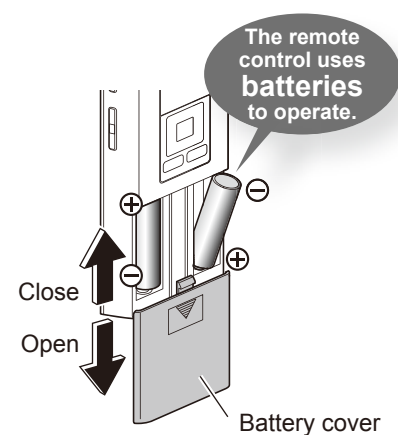

Reference

Troubleshooting

Rear and Rear soft, front cleansing, wand

Trouble	Please check	Ref. Page
<p>The wand (or cleansing water) does not come out</p>	<ul style="list-style-type: none"> ● When the temperature is low, it takes time for the wand to come out after the remote control button is pressed because the water must be warmed up first. 	-
	<ul style="list-style-type: none"> ● Did you sit on the toilet continuously for 2 hours or longer? (If so, operation is stopped for safety purposes.) → Stand up from the seat and then use again. 	-
	<ul style="list-style-type: none"> ● If the water supply pressure drops significantly, for example if water is used elsewhere or if there is a water failure, the function may stop for safety. → Disconnect the power plug and wait about 10 seconds before inserting it again. If the same symptom reappears → There may be a malfunction. Consult with the contact listed on the back cover of this manual. 	-
	<ul style="list-style-type: none"> ● The seat switch may have difficulty detecting some sitting postures. → Sit back on the toilet seat. 	11
	<ul style="list-style-type: none"> ● Are you using a toilet seat cover, a toilet lid cover or a seat for infants? → Remove any covers. When using a seat for infants or a soft highchair, remove after each use. 	
<p>The wand extends but the cleansing water does not come out / The cleansing water pressure is weak</p>	<ul style="list-style-type: none"> ● Has a water failure occurred? → Press the "STOP" button and wait until water service is restored. 	-
	<ul style="list-style-type: none"> ● Is the shutoff valve closed? 	15
	<ul style="list-style-type: none"> ● Is the water filter drain valve clogged with foreign matter? → Clean the filter. 	31
	<ul style="list-style-type: none"> ● Is the water pressure set to a low level? 	17
	<ul style="list-style-type: none"> ● Is the water drain plug loosened? → Tighten the water drain plug securely. 	40
<p>The cleansing water is cold</p>	<ul style="list-style-type: none"> ● Is the water temperature set to "OFF" or a low level? ● When the temperature of the water supply or the bathroom is low, the water temperature may be low when first sprayed. 	22
<p>Stops in the middle of use</p>	<ul style="list-style-type: none"> ● Rear, rear soft and front cleansing stop automatically after 5 minutes of continuous use. ● Does the seat switch have difficulty detecting? → Sit back on the toilet seat. If you get up slightly from the seat, or sit forward on the seat, the seating switch may temporarily stop detecting your presence. 	-
<p>Water comes out unexpectedly from the wand</p>	<ul style="list-style-type: none"> ● Water may sometimes come out from around the wand when it expands in the warm water tank. 	-

Warm air drying (SW2044, SW2043 only)

Trouble	Please check	Ref. Page
The dryer temperature is low	<ul style="list-style-type: none"> ● Is the remote control preset temperature set to a low level? 	22
Stops in the middle of use	<ul style="list-style-type: none"> ● The feature stops automatically after 10 minutes of continuous use. ● Does the seat switch have difficulty detecting? <ul style="list-style-type: none"> → Sit back on the toilet seat. If you get up slightly from the seat, or sit forward on the seat, the seating switch may temporarily stop detecting your presence. 	- 11

Toilet Seat and Toilet Lid

Trouble	Please check	Ref. Page
The toilet seat is cold	<ul style="list-style-type: none"> ● Is the toilet seat temperature set to "OFF" or a low level? 	22
	<ul style="list-style-type: none"> ● Is the ENERGY SAVER LED (orange) lit? <ul style="list-style-type: none"> • When the SEAT LED (green) is also lit. <ul style="list-style-type: none"> → The toilet seat temperature has been lowered to save energy. When you sit, the toilet seat is temporarily heated. • When the SEAT LED is OFF. <ul style="list-style-type: none"> → Energy saver is operating and has turned off the toilet seat heater. When you sit on the seat, the toilet seat heater is turned on temporarily and the seat is warmed in about 15 minutes. 	24
	<ul style="list-style-type: none"> ● Have you been seated for a long time? <ul style="list-style-type: none"> • After about 20 minutes of sitting, the temperature starts going down, and after about 1 hour, the toilet seat heater is turned "OFF". <ul style="list-style-type: none"> → Stand up from the seat and then use again. 	-
	<ul style="list-style-type: none"> ● Did you put anything on the toilet seat or the toilet lid? <ul style="list-style-type: none"> → Remove the object from the toilet seat or the toilet lid. 	-
	<ul style="list-style-type: none"> ● The seat switch may have difficulty detecting some sitting postures. <ul style="list-style-type: none"> → Sit back on the toilet seat. 	11
	<ul style="list-style-type: none"> ● Is a toilet lid or seat cover installed? <ul style="list-style-type: none"> → Remove any covers. 	11

Energy Saver

Trouble	Please check	Ref. Page
The energy saver feature is not working	<ul style="list-style-type: none"> ● Because the function takes several days learning the usage conditions before starting energy saver, the amount of energy saving may be low, depending on the frequency of use. <ul style="list-style-type: none"> → Check the energy saver feature. 	24

Troubleshooting

Deodorizer (SW2044, SW2043 only)

Trouble	Please check	Ref. Page
The deodorizer seems to be not working	● Is "DEODORIZER" set to "OFF"? → Set to "ON".	34
	● Even after sitting down, you do not hear operation sounds. → Sit back on the toilet seat.	11
	● If you hear an operation sound when you sit on the toilet seat. → Clean the deodorizing filter.	27
A strange odor is emitted	● Are you using an air freshener or deodorizer that you purchased separately? • Doing so may reduce the effectiveness of the Washlet deodorizer or cause strange odors. → Remove the air freshener or deodorizer.	-

Others

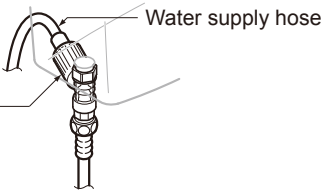
Trouble	Please check	Ref. Page
Water is leaking from the plumbing connections	<p>● If any nuts in a connection are loose, firmly tighten them with a tool such as a monkey wrench.</p> <div style="border: 1px solid black; padding: 5px; margin: 10px 0;"> <p>Do not use tools on the water supply hose connection. Tighten it by hand.</p>  </div> <p>→ If the water leak does not stop, close the shutoff valve and seek repair.</p>	-
The display on the remote control goes out	● The display goes out when no button on the remote control is pressed for 5 minutes or more.	14
The main unit is unstable	● There is clearance between the toilet seat cushion and the toilet bowl for activating the seat switch. When you sit on the toilet seat, the toilet seat subsides slightly to activate the seat switch.	11
	● Are the bolts that anchor the main unit loose? → Remove the main unit and then firmly tighten the base plate bolts.	28
The main unit makes a sound	<Only when sitting on the toilet seat.> ● You hear operation sounds for preparing the pre-mist or spraying mist in the toilet bowl. → You can turn them "OFF". (SW2044, SW2043 only)	20 34
	<When moving away from the toilet bowl after use> ● You may hear the sound of the remaining water being drained.	-
You feel air in the toilet bowl when sitting on the toilet seat (SW2044, SW2043 only)	● A mist is sprayed inside the toilet bowl to make it more difficult for dirt to adhere when sitting on the toilet seat. You may feel air when a mist is sprayed. → You can turn it "OFF".	20 34

Specifications

Item		SW2044		SW2024	
		SW2043			
Rated power supply		AC 120 V 60 Hz			
Rated power consumption		406 W		292 W	
Type of water heater		Tank type			
Power cord length		1.2 m (3.93 ft)			
Water protection level		IPX4			
Functions	Cleansing	Spray volume	Rear cleansing	Approx. 0.27 to 0.43 L/min. (Approx. 0.07 to 0.11 gal/min.) <at 0.20 MPa (29 PSI) water pressure>	
			Rear soft cleansing	Approx. 0.27 to 0.43 L/min. (Approx. 0.07 to 0.11 gal/min.) <at 0.20 MPa (29 PSI) water pressure>	
			Front cleansing	Approx. 0.29 to 0.43 L/min. (Approx. 0.08 to 0.11 gal/min.) <at 0.20 MPa (29 PSI) water pressure>	
		Water temperature	Adjustable temperature range: OFF, about 35°C to 40°C (about 95°F to 104°F)		
		Toilet tank capacity	0.64 L (0.17 gal)		
		Heater capacity	225 W		
		Safety device	Temperature fuse, overheat shutoff switch (bimetal automatic return type), anti-idling float switch		
		Backflow prevention device	Vacuum breaker, Check valve		
	Warm air dryer	Warm air temperature*	Adjustable temperature range : about 30°C to 60°C (about 86°F to 140°F)	-	
		Airflow volume	Approx. 0.27 m ³ /min (Approx. 9.53 ft ³ /min)	-	
		Heater capacity	347 W	-	
		Safety device	Temperature fuse	-	
	Heated seat	Surface temperature	Adjustable temperature range: OFF, about 28°C to 36°C (about 82°F to 97°F) <About 26°C (about 79°F) when energy saver is in operation>		
		Heater capacity	50 W		
		Safety device	Temperature fuse		
	Deodorizer	Method	O ₂ deodorization	-	
		Airflow volume	Approx. 0.16 m ³ /min (Approx. 5.65 ft ³ /min)	-	
		Power consumption	Approx. 5.3 W	-	
	Water supply pressure		Minimum required water pressure: 0.05 MPa (7.25 PSI) <dynamic>, Maximum required water pressure: 0.75 MPa (108.75 PSI) <static>		
	Water supply temperature		0°C to 35°C (32°F to 95°F)		
Working ambient temperature		0°C to 40°C (32°F to 104°F)			
Dimensions		W 391 mm × D 531 mm × H 188 mm (W 1.28 ft × D 1.74 ft × H 0.62 ft)	W 391 mm × D 531 mm × H 188 mm (W 1.28 ft × D 1.74 ft × H 0.62 ft)		
Weight		About 5 kg (about 11 lb)			

* Temperature around the warm air outlet measured by TOTO.

Limited Warranty

One Year Limited Warranty

1. TOTO warrants its washlet series ("Washlet") to be free from defects in materials and workmanship during normal use when properly installed and serviced, for a period of one (1) year from date of purchase. This limited warranty is extended only to the ORIGINAL PURCHASER of the Product and is not transferable to any third party, including but not limited to any subsequent purchaser or owner of the Product. This warranty applies only to TOTO Product is purchased and installed in USA, Canada.
2. TOTO's obligations under this warranty are limited to repair, replacement or other appropriate adjustment, at TOTO's option, of the Product or parts found to be defective in normal use, provided that such Product was properly installed, used and serviced in accordance with instructions.
TOTO reserves the right to make such inspections as may be necessary in order to determine the cause of the defect. TOTO will not charge for labor or parts in connection with warranty repairs or replacements. TOTO is not responsible for the cost of removal, return and/or reinstallation of the Product.
3. This warranty does not apply to the following items:
 - a) Damage or loss sustained in a natural calamity such as fire, earthquake, flood, thunder, electrical storm, etc.
 - b) Damage or loss resulting from any accident, unreasonable use, misuse, abuse, negligence, or improper care, cleaning, or maintenance of the Product.
 - c) Damage or loss resulting from sediments or foreign matter contained in a water system.
 - d) Damage or loss resulting from the quality of water in the region where the product is used.
 - e) Damage or loss resulting from improper installation or from installation of the Product in a harsh and/or hazardous environment, or improper removal, repair or modification of the Product. This includes locations where the water pressure is above local codes or standards. (NOTE : Product model codes allow a maximum of 80 PSI. Check local codes or standards for requirements).
 - f) Damage or loss resulting from electrical surges or lightning strikes or other acts which are not the fault of TOTO or which the Product is not specified to tolerate, including failure to use the factory equipped cord and plug or use of a loose or faulty electrical outlet or use of a current or socket other than a 120V, 60Hz electrical current from a GFI (ground, fused) socket.
 - g) Damage or loss resulting from normal and customary wear and tear, such as gloss reduction, scratching or fading over time due to use, cleaning practices or water or atmospheric conditions, including but not limited to, the use of bleach, alkali, acid cleaners, dry (powder) cleaners or any other abrasive cleaners or the use of metal or nylon scrubbers.
4. If the Danger Label which has been placed over the seams on the back of the Product's top unit is broken or otherwise not intact, this limited warranty is void.
5. In order for this limited warranty to be valid, proof of purchase is required. TOTO encourages warranty registration upon purchase to create a record of Product ownership at <http://www.totousa.com>. Product registration is completely voluntary and failure to register will not diminish your limited warranty rights.
6. If the Product is used commercially or is installed outside of USA, Canada, TOTO warrants the Product to be free from defects in materials and workmanship during normal use for one (1) year from the date of installation of the Product, and all other terms of this warranty shall be applicable except the duration of the warranty.
7. This warranty gives you specific legal rights. You may have other rights which vary from state to state, province to province or country to country.
8. To obtain warranty repair service under this warranty, you must take the Product or deliver it prepaid to a TOTO service facility together with proof of purchase (original sales receipt) and a letter stating the problem, or contact a TOTO distributor or products service contractor, or write directly to TOTO U.S.A., INC., 1155 Southern Road, Morrow, GA 30260 (888) 295 8134 or (678) 466-1300, if outside the U.S.A. If, because of the size of the Product or nature of the defect, the Product cannot be returned to TOTO, receipt by TOTO of written notice of the defect together with proof of purchase (original sales receipt) shall constitute delivery. In such case, TOTO may choose to repair the Product at the purchaser's location or pay to transport the Product to a service facility.

WARNING! TOTO shall not be responsible or liable for any failure of, or damage to, this Product caused by either chloramines in the treatment of public water supply or cleaners containing chlorine (calcium hypochlorite).

NOTE: The use of a high concentrate chlorine or chlorine related product's can seriously damage the fittings. This damage can cause leakage and serious property damage.

THIS WRITTEN WARRANTY IS THE ONLY WARRANTY MADE BY TOTO. REPAIR, REPLACEMENT OR OTHER APPROPRIATE ADJUSTMENT AS PROVIDED UNDER THIS WARRANTY SHALL BE THE EXCLUSIVE REMEDY AVAILABLE TO THE ORIGINAL PURCHASER. TOTO SHALL NOT BE RESPONSIBLE FOR LOSS OF THE PRODUCT OR FOR OTHER INCIDENTAL, SPECIAL OR CONSEQUENTIAL DAMAGES OR EXPENSES INCURRED BY THE ORIGINAL PURCHASER, OR FOR LABOR OR OTHER COSTS DUE TO INSTALLATION OR REMOVAL, OR COSTS OF REPAIRS BY OTHERS, OR FOR ANY OTHER EXPENSE NOT SPECIFICALLY STATED ABOVE. IN NO EVENT WILL TOTO'S RESPONSIBILITY EXCEED THE PURCHASE PRICE OF THE PRODUCT. EXCEPT TO THE EXTENT PROHIBITED BY APPLICABLE LAW, ANY IMPLIED WARRANTIES, INCLUDING THAT OF MERCHANTABILITY OR FITNESS FOR USE OR FOR A PARTICULAR PURPOSE, ARE EXPRESSLY DISCLAIMED. SOME STATES DO NOT ALLOW LIMITATIONS ON HOW LONG AN IMPLIED WARRANTY LASTS, OR THE EXCLUSION OR LIMITATION OF INCIDENTAL OR CONSEQUENTIAL DAMAGES, SO THE ABOVE LIMITATION AND EXCLUSION MAY NOT APPLY TO YOU.

TOTO

TOTO U.S.A., Inc. 1155 Southern Road Morrow, GA 30260
Phone : (770) 282 8686

Warranty Registration and Inquiry

For product warranty registration, TOTO U.S.A. Inc. recommends On-Line Warranty Registration. Please visit our web site <http://www.totousa.com>. If you have questions regarding warranty policy or coverage, please contact TOTO U.S.A. Inc.,

Customer Service Department, 1155 Southern Road, Morrow, GA 30260 (888) 295 - 8134 or (678) 466 - 1300 when calling from outside of U.S.A.

- You are advised to record the following information to allow quick service.

Date of purchase :	Name of shop :
Date : year month day	Tel : ()