



bidets reimaged

Nobelet Instruction Manual

TABLE OF CONTENTS

- 1. Safety precautions 2
- 2. Signs and meanings 2
- 3. Warnings..... 3-6
- 4. Line drawings
 - 4.1.Remote Control 7
 - 4.2.Bidet Toilet..... 8
- 5. Automatic Functions..... 9
- 6. Getting to know your remote 10
- 7. Getting to know your lid and seat
 - 7.3. Opening and closing the lid 10
 - 7.4. Opening and closing the seat..... 11
 - 7.5. Adjustable Seat temperature..... 12
 - 7.6. Setting automatic lid opening/closing 12
 - 7.7. Setting automatic seat opening/closing 12
 - 7.8. Setting of sensing distance 12
- 8. Getting to know your bidet
 - 8.9. Stop..... 13
 - 8.10. Rear Wash..... 13
 - 8.11. Adjustable Water Pressure 13
 - 8.12. Adjustable Spray Wand Position..... 14
 - 8.13. Adjustable Water Temperature 14
 - 8.14. Front Wash 14
 - 8.15. Drying..... 14
 - 8.16. Adjustable Drying Temperature 15
 - 8.17. Spa 15
 - 8.18. Strong and Weak Massage 15
 - 8.19. Cool and Warm Massage 16
 - 8.20. Children Wash..... 16
 - 8.21. Eco Mode 16
 - 8.22. Setting the Automatic Drying Function 17
 - 8.23. User Presets 17
- 9. Getting to know your bowl
 - 9.24. Night Light..... 17
 - 9.25. Water Replacement 17
 - 9.26. Automatic Flush 18
 - 9.27. Adjusting the Flush Time 18
- 10. Pairing the remote 19
- 11. Troubleshooting Guide 19
- 12. Cleaning and care 23
- 13. Product specifications..... 26

SAFETY PRECAUTIONS

Basic safety precautions must be followed when handling or using electrical products, especially those within the reach of children. Please make yourself aware of the following guidelines:

- This product should only be used by children who are 8 years and older or by persons with disabilities who have received supervision and instructions on the safe use and the hazards involved when using this product.
- It is unwise to allow children to play with this electronic bidet, supervised or not.
- It is not recommended that children who are unsupervised be allowed to clean and perform maintenance for this product.

SIGNS AND MEANINGS



WARNING

Improper operations due to ignorance of the instructions may result in death or injury



CAUTION

Improper operations due to ignorance of the instructions may result in body injury and property loss



FORBIDDEN

Not allowed



MUST

Should be followed

WARNINGS



Please do not touch the electrical outlet with wet hands.

- Or it may cause electric shock

Please do not pour liquids such as water or detergent on top of the electronic outlet and the toilet.

- Or it may cause fire, electric shock, heat or short circuit
- Or it may cause injury and indoor water seepage because of the damaged part

Never attempt to disassemble, repair, or alter the product yourself.

- Or it may cause fire, electric shock, heat or short circuit



Please do not install the toilet in the car, ship, or any other moving objects.

- Or it may cause fire, electric shock, short circuit or fault
- Or the ceramic, seat, and the main part will be damaged due to fall

Do not use if it is broken. Under the following condition, please turn off the toilet and the water angle valve.

- Water leakage from the pipe or inner parts of the toilet
- Smoke
- Unusual heating and smell
- Blockage



Continuous use of the toilet despite of the damages and above-mentioned conditions may result to fire, electric shock, heat, short circuit, injury, and indoor water seepage.

Please don't use seawater and other water except for tap water or potable well water (underground water)

- Or it may cause skin irritation or inflammation

During thunderstorms, do not touch the electrical plug

- Or it may cause electric shock

Please do not let the water inlet soft pipe connect to the electrical plug and outlet

- Or it may cause fire, electric shock, heat, and short circuit because of moisture condensation

Please do not damage the power cable or plug. Do not strike, yank, twist, bend excessively, or alter the electrical cords. Also, do not place anything heavy on, bind or pinch the cords

- Or it may cause fire, electric shock, heat, and short circuit if it's broken

Please do not use a loose or faulty electrical outlet

- Or it may cause fire or short circuit

Please use the electrical outlet and wire appliance in the specified outlet

- Or it may cause fire

Please do not put your finger or anything into the warm air outlet. Do not cover or put objects or clothes on the air outlet.

- Or it may cause scalding, electric shock, or fire





Pay attention to the low temperature scalding
Improper use of warm seat may cause low temperature scalding

If you sit for a long time, please turn the temperature setting to "off level. Please turn the seat temperature setting to "off level, warm air-dry temperature to "low" level under the following situations

- Children and elders or those who cannot adjust the temperature to the proper level
- Persons with disability and patients with behavioral problems
- People who have taken medicines with side effects of hypnosis (hypnotics, cold meds, etc.), or those who are excessively drinking alcohol, too tired, and with somnolence



This is an electrical product, please do not install it in a place where it will get wet easily or in areas with high humidity. If installed in the bath- room, please install a ventilator to maintain the bathroom ventilation. Or it may cause fire or electric shock

The product must be connected to the cold water supply

- Or it may cause body burn or machine fault

Please confirm if the electrical outlet is connected to the ground.

- Or it may cause electric shock because of fault or short circuit

The outlet for power wire should obey the following rules or it may cause fire or electric shock.

Please ask the maintenance team or similar department to replace the power soft wire if it is broken to avoid danger. Repair work must be done by professionals.



Please do not throw lighted cigarettes and other flaming material into the toilet.

- Or it may cause fire



Do not install this product in a room where it may be frosted. The room temperature can't be less than 39.2 degree Fahrenheit.

Don't block the air outlet



Do not use excessive force when closing the cover and the seat.

Do not intentionally soil, spray, or block the cleaning nozzle.

Pull out the plug regularly and clean off the dust with a dry cotton cloth.

Use the new hose parts that come with the product. The old ones should not be reused.



Keep the product away from the heater.

Close the water supply valve before taking out the junction block.

If you need to be away for a long time, be sure to plug it out, turn off the water, and drain the remaining water inside the bidet. The remaining water may freeze when the product is transported over long distances or stored for a long time in cold winter or alpine region.

LINE DRAWINGS

Remote Control

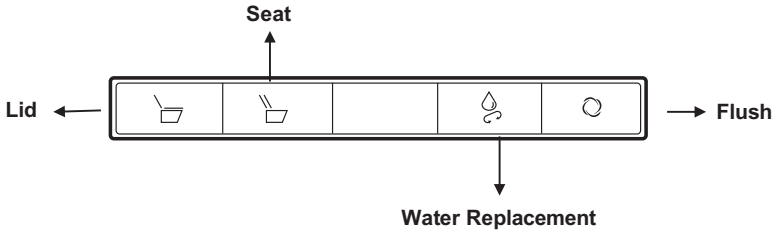
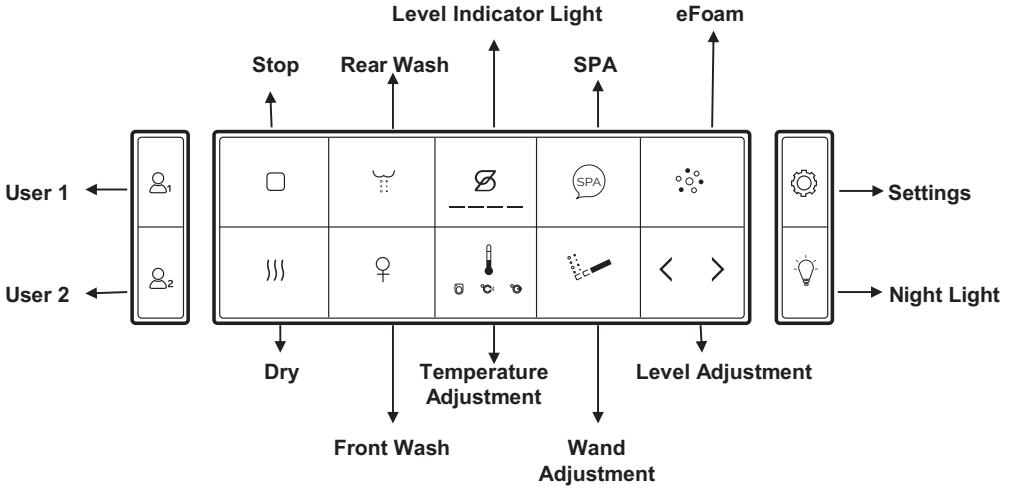

Note: The eFoam feature is currently available on the Ganza II (G2ETBCERN-12.WH) model only.

Electronic Bidet

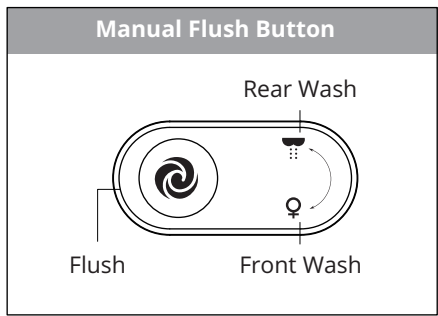
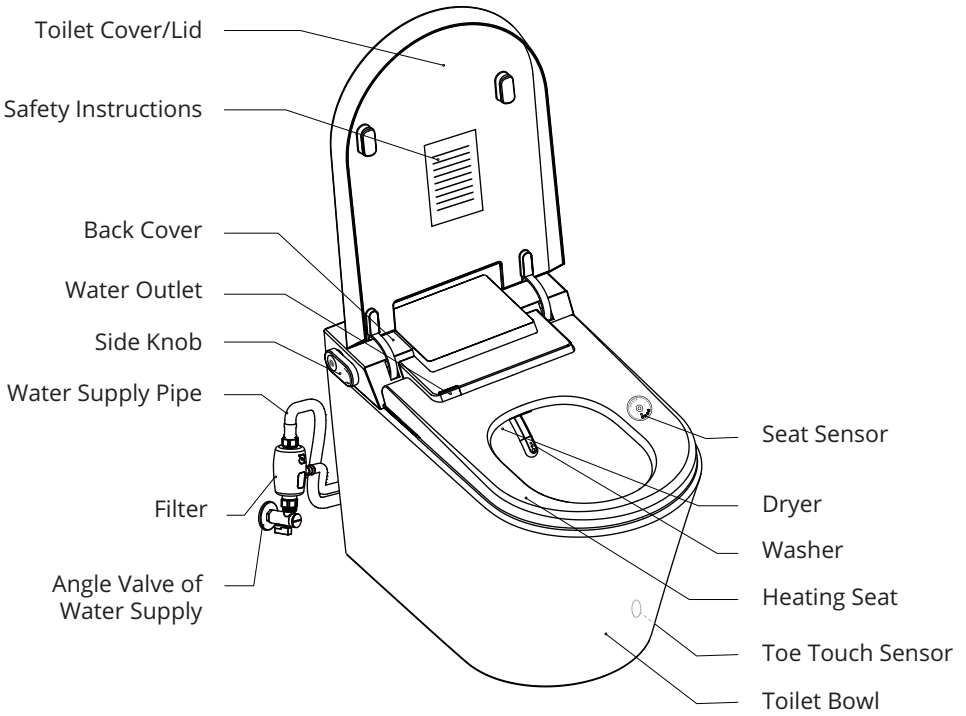

AUTOMATIC FUNCTIONS

Self-Cleaning Wand

The spray wand cleans itself before and after every use by rinsing itself as it enters and exits.

Deodorizer

The deodorizer starts anytime the seat sensor has been activated. You can stop the deodorizer by pressing the stop button in idle mode. The deodorizer will stop automatically after a user leaves the seat for around 60 seconds.

Pre-Rinse

The Pre-Rinse starts anytime the seat sensor has been activated. A quick jet of water covers the bowl to help waste slide down.

Automatic Flush

The toilet will flush automatically when being changed from washing to drying, or when someone leaves the seat sensor if no washing has occurred. This setting can be turned on and off.

Automatic Opening/Closing

The lid and seat can be set to automatically open when approaching the toilet. This setting can be turned on and off.

GETTING TO KNOW YOUR REMOTE

Level Indicator Light

- The Level Indicator Light  will display the current level. — — — — —
- The *water pressure adjustment, spray wand position adjustment, and the temperature adjustments* have four gear positions: Close, Low, Mid, and High. When you successfully change from one level to the other the light indicator changes position and you hear one beep. If you hear two beeps you have reached the maximum or minimum level.



GETTING TO KNOW YOUR LID & SEAT

Opening and Closing the lid

There are four methods to open and close the lid. These methods include (1) by hand, (2) using the remote, (3) using the foot sensor and (4) automatically.

- Method 1: Using your hand you can open or close the lid.
 - Note: Do not interrupt the lid opening or closing with your hand if it is moving via another method. This can cause the gears to break.
- Method 2: Press the Lid button to open or close the lid.
 - Note: If the seat is also open, it will close the seat and the lid together.





- Method 3: When the lid is closed, gently tap the location of the foot sensor.
 - Note: You cannot close the lid using the foot sensor.
- Method 4: The lid will automatically open when you are close to it if the automatic lid function is active. The lid will automatically close on its own after no motion is detected for approximately 30 seconds.
 - Note: You can activate or deactivate this feature. See instructions on this feature on page 12.

Opening and Closing the seat

There are four methods to open and close the seat. These methods include (1) by hand, (2) using the remote, (3) using the foot sensor and (4) automatically.



- Method 1: Using your hand you can open or close the seat.
 - Note: Do not interrupt the lid opening or closing with your hand if it is moving via another method. This can cause the gears to break.
- Method 2: Press the Seat button to open or close the seat.
 - Note: If the lid is closed, it will open the lid and seat together.
- Method 3: When the seat is closed, gently tap the location of the foot sensor.
- Method 4: The seat can automatically open when you are close to it if the automatic seat function is active. The seat will automatically close on its own after no motion is detected for approximately 30 seconds.
 - Note: You can activate or deactivate this feature. See instructions on this feature on page 12.
 - Note: If the automatic lid feature is turned off, the seat will not open even if this feature is activated.

Adjustable Seat Temperature

- Press the Temperature Adjustment button  until the seat temperature icon  is selected. There are four levels of temperature adjustment which can be seen on the Level Indicator Light.
- Use the Level Adjustment button   to increase or decrease the seat temperature.



Setting Automatic Lid Opening/Closing

Factory Settings: On







- Press and hold the Settings button  and then press the Lid button .
- When Automatic Lid Opening activates you hear a long beep.
- When Automatic Lid Opening deactivates you hear a short beep.

Setting Automatic Seat Opening/Closing

Factory Settings: On

- Press and hold the Settings button  and then press the Seat button .
- When Automatic Seat Opening activates you hear a long beep.
- When Automatic Seat Opening deactivates you hear a short beep.



Setting of Sensing Distance (Cover Flip/Seat Flip)

- Press and hold the Settings button , then use the Level Adjustment button   to increase or decrease the sensing distance.
- Press the  button to decrease the sensing distance.
- Press the  button to increase the sensing distance.
- The Level Indicator Light  will display the current operating level.
— — — — —



- The sensing distance has five levels. When you successfully change from one level to the next you will hear one beep. If you hear two beeps, the sensor has reached its maximum or minimum setting.

GETTING TO KNOW YOUR BIDET





Stop

- You can turn the toilet power on and off by pressing and holding the Stop button  for approximately 2-3 seconds.
- Press the Stop button  to immediately end any of the following functions: rear wash, front wash, drying, strong & weak massage, cold & warm massage, children wash, self-cleaning of nozzle, drying, and live water replacement.

Rear Wash

- When the user is seated, press the Rear Wash button  to start rear washing. The pipe oscillating function starts automatically to help increase the cleaning area. Press the Rear Wash button  again to stop the oscillating function.
- Press the Stop button  to stop Rear Wash.
 - Note: It will stop cleaning and start the drying function automatically after continuous cleaning for about 90 seconds.



Adjustable Water Pressure

- When you are washing, use the Level Adjustment button   to increase or decrease the water pressure. There are four levels of adjustment which can be seen on the level display.
- Use the Level Adjustment button   to increase or decrease the water pressure.

Adjustable Spray Wand Position

- While washing, press the Wand Adjustment button . There are four levels of adjustment which can be seen on the level indicator light.
- Use the Level Adjustment button < > to increase or decrease the wand position.

Adjustable Water Temperature

- Press the Temperature Adjustment button  until the water temperature light  is selected. There are four levels of temperature adjustment which can be seen on the level indicator light.
- Use the Level Adjustment button < > to increase or decrease the water temperature.



Front Wash

- When the user is seated, press the Feminine Wash button  to start front washing. The oscillating function starts automatically to help increase the cleaning area. Press the Feminine Wash button again to stop the oscillating function.
- Press the Stop button to stop Feminine Wash.
 - Note: It will stop cleaning and start the drying function automatically after continuous cleaning for about 90 seconds.

Drying

- When the user is seated, press the Dry button  to start the drying function.
- Press the Stop button to stop drying.
 - Note: The dryer will automatically turn on after a user has finished washing. This feature can be activated and deactivated. See more on page 17.
 - Note: The dryer will stop automatically after continuous drying for about 5 minutes.

Adjustable Drying Temperature

- While you are drying, press the Temperature Adjustment button  until the air temperature light  is selected. There are four levels of temperature adjustment which can be seen on the level indicator display.
- Use the Level Adjustment button < > to increase or decrease the drying temperature

Spa

- When the user is seated, press the Spa button to activate the Spa function.
- When the Spa function is activated, it will begin washing and continuously switch between high to low pressure and hot to cold water temperature.
- Pressing the Spa button again during the wash will pause/un-pause the pressure and temperature adjustments but continue washing.
- Press the Stop button  to stop the SPA function.
- Note: The spa washing will automatically end after continuous washing of about 5 minutes.

Strong & Soft Massage

- While the user is washing, press and hold the Rear Wash button  to turn on/off the Strong & Weak Massage. The water pressure will begin continuously switching between high and low pressure.
 - Note: Strong & Weak massage can be used in rear wash and front wash. Pressing and holding will not switch between the two different types of washing.
 - Note: Pressing stop will end the wash. To end the pressure adjustment but continue washing, you need to press and hold the Rear and Wash button.



Cool & Warm Massage

- While the user is washing, press and hold the Font Wash button  to turn on/off the Cool & Warm Massage. The water temperature will begin continuously switching between low and high temperature.
 - Note: Cool & Warm massage can be used in rear wash and front wash. Pressing and holding will not switch between the two different types of washing.
 - Note: Pressing stop will end the wash. To end the temperature adjustment but continue washing, you need to press and hold the Rear and Wash button.

Children Wash



- When the user is seated, press and hold the User 1 button  for approximately 2-3 seconds. Child washing begins and will automatically stop after 90 seconds. Child washing presets the water pressure to low and the water temperature to warm.
 - Note: Water temperature, water pressure, spray wand position selection, oscillating, and massage functions cannot be adjusted when this function starts.

Eco Mode

- Press and hold the Settings button  and then press the Night Light button  to turn on/off the Eco Mode. When Eco Mode is active, the side knob glows green. When Eco Mode is not active, the side knob glows white. Eco Mode keeps the seat temperature lower when nobody is on the toilet.

Setting The Automatic Drying Function

Factory Settings: On

- Press and hold the Settings button  and then press the Dry button  to turn on/off the automatic drying function.
- When the function is deactivated, you will hear a short beep.
- When the function is activated, you will hear a long beep.

User Presets

- Press the User button  to change to a different user's personal mode one by one. The selected settings of the User mode will be used automatically. The functions performed at this time are all according to the corresponding parameter settings.
- In User mode, user's adjustment about water flow, temperature, and position will be automatically saved for later memory.
- The remote will exit the user preset after entering standby state for some while.

GETTING TO KNOW YOUR BOWL



Night Light

- Press the Night Light button  to turn on/ the night light. You will notice the indicator level light up momentarily a short beep when the night light is turned on or off .

Water Replacement

- Press the Water Replacement button  to start this function. It will stop automatically after it is completed.
 - Note: Please use this function when you have not used the toilet for a long time. This will replace the water that has been sitting in the hoses. It is normal that water drains from the wand area when the function is activated.

Automatic Flush

- Press and hold the Setting button , and then press the Flush button  to turn this function on/off. When the function is turned on, you will hear short beep. When you turn it off, you will hear a long beep.
 - Note: When automatic flush is off, the toilet will not flush when you a) leave the seat after sitting down b) leave the seat after standing as detected by the sensor and c) using the toe touch.

Adjusting the Flush Time

- Rotate the side knob downwards for Front Wash  for approximately 8 seconds. When you have successfully entered this mode, you will hear a double beep and the green light on the knob begins flashing green.
- You are now ready to adjust the amount of water that fills the bowl before the flush. Using the remote press the > or < button to increase or decrease the amount. When you hear a double beep, you have reached the maximum or minimum setting. Once you have set your desired level press the flush button on the side knob. Your side knob begins flashing yellow.
- You are now ready to adjust the length of time that the SyphonAssist jet is active. Using the remote press the > or < button to increase or decrease the amount. When you hear a double beep, you have reached the maximum or minimum setting. Once you have set your desired level press the flush button on the side knob. Your side knob begins flashing red.
- You are now ready to adjust the amount of water that fills the bowl after the flush. Using the remote press the > or < button to increase or decrease the amount. When you hear a double beep, you have reached the maximum or minimum setting. Once you have set your desired level press the flush button on the side knob. You have now exited the flushing time adjustment.
 - Note: Waiting too long without any buttons pressed in any of these adjustments will cause the toilet to exit this mode.

PAIRING THE REMOTE



- 1) Unplug the bidet (tripping the GFCI on the plug will also work).
- 2) Press and hold the SPA button until the 4 lights on the front of the remote start flashing. Then release the SPA button.
- 3) Hold the remote close to the electronic bidet combo and at the same time proceed to step 4.
- 4) Plug in the toilet (or reset the GFCI) and listen for the beep. Once the beep sounds, you will have successfully paired your remote control with your toilet bidet combo.

TROUBLESHOOTING GUIDE

Error Code	Error Description
E1	Thermal module temperature sensor failure
E2	Seat temperature sensor failure
E3	Dryer temperature sensor failure
E4	Heater communication error
E5	Control board and adapter plate communication timeout
E6	Water shortage
E7	Emergency battery backup is low or not connected
E8	Room temperature sensor failure
E9	Heater or main control board failure

Note: please contact support@troneplumbing with your error code.

Toilet

Fault	Failure Analysis	Solutions
Unclean flush when the water pressure is low	Angle valve filter blocked	Clean the filter according to the manual
	Too low water pressure	Measure if the water volume is 10L per 30s or not (buy a booster pump)
	Bended water inlet pipe	Ensure that the water supply line is not kinked
Normal water pressure but flush is unclean and has no siphon	Outlet has air leakage	Consult a professional repair man
	S-pipe is blocked	Use a toilet dredge
Normal water pressure but flush is not working	Check if the angle valve is closed or not	Open the angle valve
	Flush valve failure	Consult a professional repair man

Dryer/Fan/Seat Temperature

Fault	Failure Analysis	Solutions
Drying with cold air	Check the fan temperature setting if it's off or low	Adjust the fan temperature according to the manual
Seat is not warm enough	Check the seat temperature setting if it's off or low	Adjust the seat temperature according to the manual

Power Switch

Fault	Failure Analysis	Solutions
Product Not Working	Check whether the socket has power or not and if the plug is loose.	Check circuit
	Check whether the toilet is turned on or not (if the side button is on or not)	Press the power on/off button until the side button's light is on
	Check whether the leakage protection button in the plug is on or off by checking the light of the leakage protection plug	Pull out the plug and connect it later. Press the reset switch of the leakage protection plug. If it's still not working, pull out the plug and ask a professional repair man for help.

Remote

Fault	Failure Analysis	Solutions
Remote not working	Low battery	Replace the old battery
	Check if there is any water inside the remote	Dry the remote with a dry cotton cloth

General Problems

Fault	Failure Analysis	Solutions
No water coming out from the nozzle	Check if there's no water supply	Wait for water supply to be back to normal
	Check if the angle valve is closed or not	Open the angle valve
	Check if the inlet water filter is blocked or not	Clean the water filter
	Check if the water inlet pipe is bended or not	Ensure that the inlet pipe
Cleaning strength is not enough	Check if the water pressure is set to low	Increase the water pressure using the remote
	Check if inlet filter is blocked or not	Clean the inlet filter
Water temperature is not warm enough	Check if the water temperature is set to low or not	Adjust the water temperature according to the instructions given in this manual
Spray wand is always dripping water	Solenoid valve failure	Consult a professional repair man
Spray wand cannot be used	Seat body induction failure	Consult a professional repair man

CLEANING AND CARE

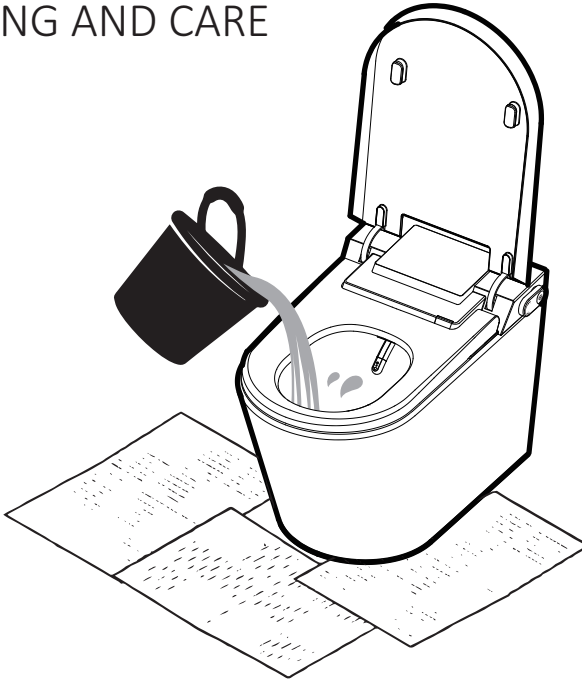

Note: Turn off the power, close the water supply angle valve, and stop the water supply before doing any maintenance work. DO NOT rinse this product with water during maintenance.

Toilet Bowl Cleaning

- Please ensure that the electrical plug is taken out.
- Please use soft damp cloth to wipe the toilet shelf and seat. The dirt should be easily removed. If it's not, you may use neutral detergent.

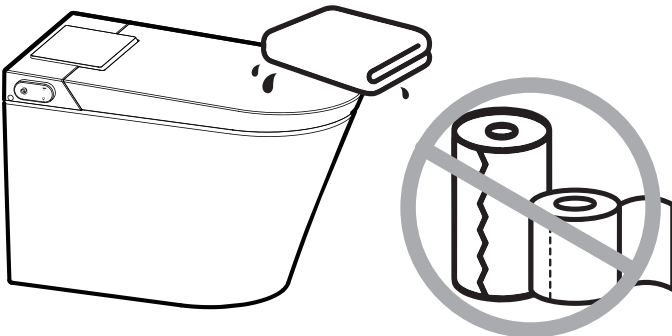

Self-Cleaning Nozzle Maintenance

- Rotate the knob upwards to the back wash setting and hold it in the upwards position for approximately 2-3 seconds. The spray wand will then extend.
- Wash the cleaning tube and nozzle with a toothbrush coated with toothpaste.
- Do not use excessive force. Press the Stop button to take the nozzle tube back once you're done cleaning.

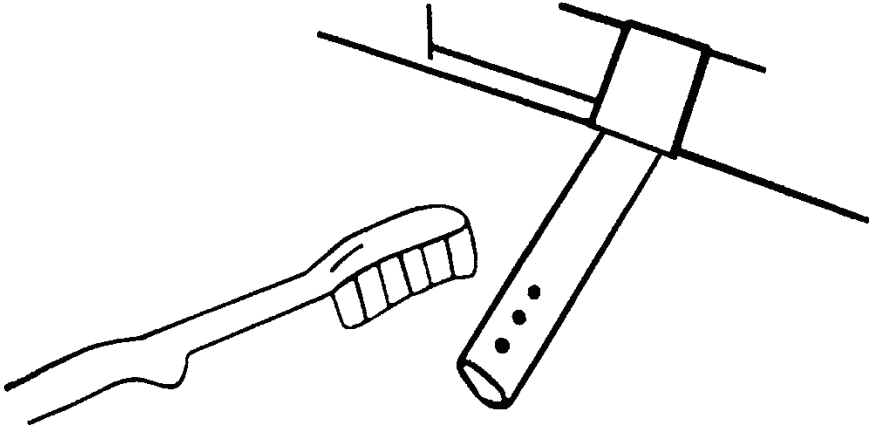

Cleaning the Junction Block

- The junction block is installed on the water supply angle valve. It cannot be pressed by a foreign matter and must be away from any corrosive substances.
- The junction block should be installed away from heat sources such as heaters, Yuba lights, etc. It should be installed indoors and should not be exposed to sunny or cold weather.
- Please replace the junction block after it has reached the end of its service life.
- If you are not at home for a long time (due to travel, etc.), please turn off the water supply angle valve.
- It is recommended to change the filter every 6 months.

Cleaning the Steel Mesh Filter

- Please clean the steel mesh (or replace the filter) according to the local water quality.
- When the cleaning strength becomes weaker, clean the steel mesh or replace the filter on time. Close the water supply angle valve when disassembling the filter. Tighten the filter during installation to avoid water leakage.
- Turn the filter counterclockwise with a coin to open the filter. It is recommended to clean the steel mesh every 1-2 months.

Replacing the Battery

- Loosen the screws that secure the battery cover, remove the old battery and give it to a professional recycling agency.
- Replace the new battery and lock the fixing screw as shown in the picture.
- Refer to the battery installation picture to install the battery properly.
 - Note: Keep the battery out of reach of children. Please confirm the positive and negative of battery. Do not change, disassemble, or burn the battery. Don't mix it with old batteries or different types of batteries to avoid leakage or explosion.
 - Note: The battery case has a moisture-proof function. Please tighten the fixing screws to achieve a good sealing effect.

PRODUCT SPECIFICATIONS

Model Number	NETBCDER-12.WH (white model) NETBCDER-12.MB (matte black model)
Rated Voltage	120V-, 60Hz
Rated Power	1150W
Power Cable	1.5m
Applicable Water Pressure	40 - 90 PSI
Water Temperature	39.2 to 95 °F
Ambient Temperature	39.2 to 104 °F
Net Weight	99.2 lbs
Waterproof Level	IPX4
Cleaning Water Flow	0.13 - 0.19 gpm (0.5 - 0.7L/min)
Seat Temperature Adjustment	Total 4 gears (Normal: around 104 °F)
Water Temperature	Total 4 gears (Normal: around 104 °F)
Wind Temperature	Total 4 gears (Normal: around 104 to 149 °F)
Cleaning Time	Normal cleaning is about 90 seconds, SPA cleaning is about 5 mins.
Nozzle Position Adjustment	4 gears
Heating Mode	Frequency Conversion Heat
Safety Device	Leakage Protection Switch, Wind/Seat/Water Temperature Protection
Deodorization	Nano Intelligent Deodorization

support@troneplumbing.com
www.troneplumbing.com