

MultiChoice™ Universal Pressure Balance Tub and Shower

TECK®
COMMERCIAL



Specification: (example)

- R10000-UNWS ROUGH-IN only**
 - Concealed in-wall MultiChoice™ universal valve
 - Back-to-back capability, Integral screwdriver stops
 - **Heavy Duty forged brass** valve body
 - 1/2" Universal inlets to accept 1/2" copper, 1/2" iron pipe, PEX or CPVC adaptors
 - 1/2" Male thread inlets/outlets
 - FINISH TRIM ONLY:**
 - Pressure Balancing cartridge with checks
 - Polished chrome plated finish
 - Non-removeable red/blue temperature markings
- and ... with ... (add product variation)
with ... (add shower)
with ... (add valve handle)

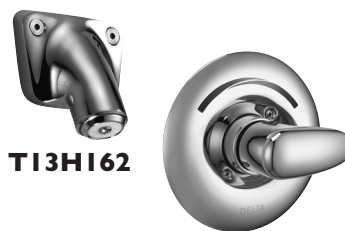

Engineer/Architect Approval









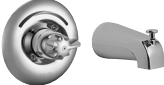

Model Specified:

Approval:

Date:

TUB AND SHOWER DESCRIPTION	PRODUCT NO.
ROUGH-IN Valve	R10000-UNWS
FINISH TRIM only	T13H



PRODUCT VARIATION	SHOWER	HANDLE
0 <input type="checkbox"/>	0 Specify "0" When No Shower Outlet Required <input type="checkbox"/>	0 <input type="checkbox"/>
1 Shower Valve Only  <input type="checkbox"/>	1 Standard Brass Fixed Spray Showerhead Arm & Flange 2.2 USGPM (8.4 L/min.)  <input type="checkbox"/>	1 <input type="checkbox"/>
2 Tub and Shower  <input type="checkbox"/>	2 3-Function Touch-Clean Showerhead, Arm & Flange 2.5 USGPM (9.5 L/min.)  <input type="checkbox"/>	2 85mm (3.33") Metal Lever Handle  <input type="checkbox"/>
3 <input type="checkbox"/>	3 Showerhead Arm & Flange 1.5 USGPM (5.7 L/min.)  <input type="checkbox"/>	3 57mm (2.24") Lever Blade Handle  <input type="checkbox"/>
4 <input type="checkbox"/>	4 <input type="checkbox"/>	4 <input type="checkbox"/>
5 <input type="checkbox"/>	5 Handshower, 610mm (24") S/S Grab Bar with ADA Slide 1.5 USGPM (5.7 L/min.) (1)  <input type="checkbox"/>	5 <input type="checkbox"/>
6 <input type="checkbox"/>	6 30° Vandal Resistant Cast Wallmount Showerhead 1.5 USGPM (5.7 L/min.)  <input type="checkbox"/>	6 <input type="checkbox"/>
7 <input type="checkbox"/>	7 <input type="checkbox"/>	7 <input type="checkbox"/>
8 <input type="checkbox"/>	8 H ₂ Okinetic Technology® Showerhead, Arm & Flange, 1.5 USGPM (5.7 L/min.)  <input type="checkbox"/>	8 <input type="checkbox"/>
9 <input type="checkbox"/>	9 <input type="checkbox"/>	9 <input type="checkbox"/>

Set screw shower arm flange supplied on Shower Option No. 1, 2, 3 and 8. (1) Two check valves in handshower. Refer to www.specselect.com for individual models.

See Page DSP-B-R10000-HDF for additional Rough-In options.

Delta reserves the right (1) to make changes in specifications and materials, and (2) to change or discontinue models, both without notice or obligation. Dimensions are for reference only. See current full-line price book or www.specselect.com for finish options and product availability.

Flowrates are at 80 PSI.

See Page DSP-SHWA Rev. C for Add-On options available. Note: Use this page front and back as a product submittal sheet.

DSP-T13H1 Rev. C



TECK[®]
COMMERCIAL

MultiChoice™ Universal Pressure Balance Tub and Shower

Approvals:

- CSA certified
- Complies to ASME A112.18.1
- Pressure Balance Handle ADA Compliant and meet Handicapped Accessibility Standard ASME A117.1 of less than 5 lbs. operating force.
- Pressure Balance Valve ASSE 1016
- Handshower back flow protection provided by two integral certified check valves in series, which operate independently, ASME A112.18.3 and ASME A112.18.1 / CSA B125.1.
- IAPMO listed

(Contact Delta Representative for State and/or Local Approvals.)

FLOWRATE vs PRESSURE

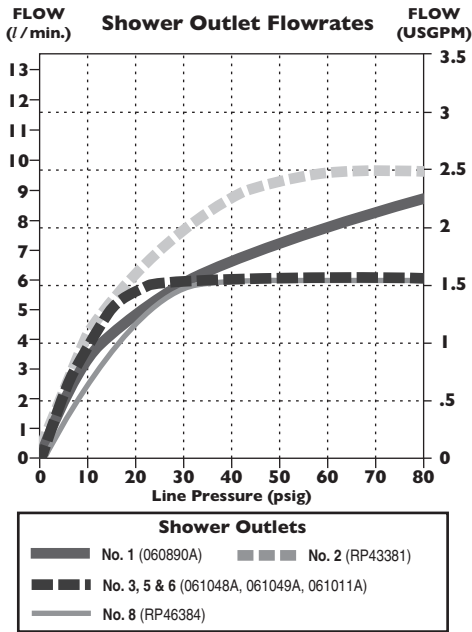

FLOWRATE vs PRESSURE

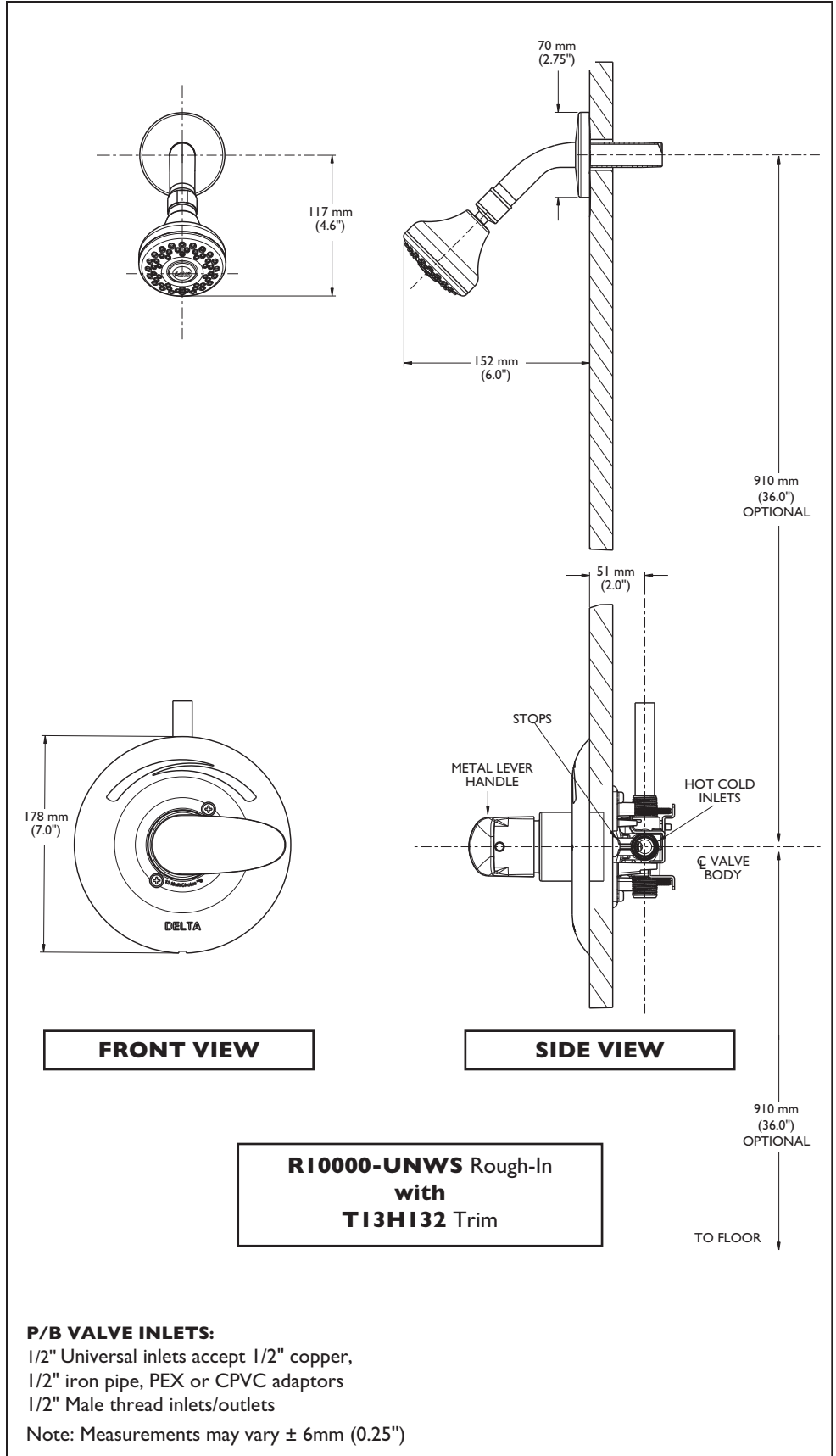
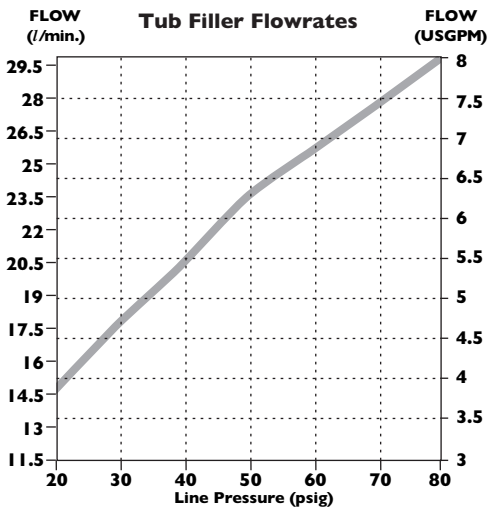

Refer to www.specselect.com for individual models.

Note: Use this page front and back as a product submittal sheet.

TO WHOM IT MAY CONCERN

Delta Faucet Company handshowers are certified as being compliant to the national consensus standard ASME A112.18.1/CSAB125.1 for Plumbing Supply Fittings. This standard is referenced in many state/provincial and city codes as well as the International Plumbing Code, the Uniform Plumbing Code and the Canadian Plumbing code.

The backflow protection provided in these hand showers is by means of two check valves which individually meet the requirements of ASME A112.18.3 Performance Requirements for Backflow Protection Devices and Systems in Plumbing Fixture Fittings, which is referenced in ASME A112.18.1/CSA B125.1. These check valves are listed as being in compliance with the ASME A112.18.3 standard, which requires that two such devices are required for suitable backflow protection in a finished product.

With this type of backflow protection these handshowers can be used with any valve which may or may not have its own backflow protection system and do not rely on additional devices such as vacuum breakers to be installed with them as the protection is integral and cannot be removed.

If you require any additional information, please contact us.

Yours sincerely,

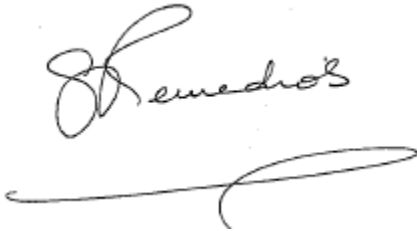

Sally Remedios,
Manager, Product Compliance
Ph: 317 587 1270
Fax: 317 848 0750
E-mail sar@deltafaucet.com