

American Standard

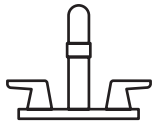

American Standard is devoted to making life, in the heart of your home, better every day...

...so, thank you for inviting us in! With the very best in kitchen and bathroom products, we are here to help make your life happier, healthier and simpler. Our commitment to quality, innovation and performance has made us part of your everyday routine for nearly 150 years, and we look forward to being a part of your life for many years to come.

Learn more at www.AmericanStandard.com

REGISTER YOUR WARRANTY

Try the easy-scan **QR code** to quickly enter your information or find your product's detailed warranty here:

www.AmericanStandard.com/warranty



Registering allows you to keep your product information safe, and us the ability to contact you in the event of a product recall or *any* news about your purchase.

And if ever you have a question or need help...?

Call us at 1-855-815-0004

OWNERS MANUAL

Aspirations™ Bath and Shower Wall

60x32x84, 60x32x72, 48x36x84, 60x36x84, 60x36x72

2951SWT32 / 2952BWT32 / 2951SWT48 / 2951SWT36 / 2952BWT36

RECOMMENDED TOOLS AND MATERIALS

Installation steps will indicate which tools should be used with associated letter



Level

A

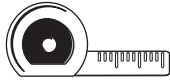

Tape Measure

B

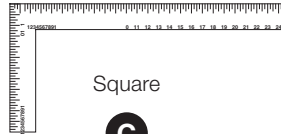

Square

C



Pencil

D



Painter's
Masking Tape

E

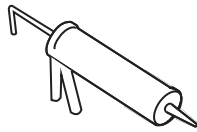

Caulking Gun

F

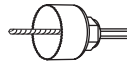

Hole Saw

G



Safety
Equipment

H

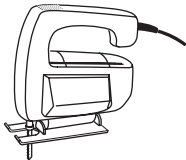

Jig Saw with fine
tooth blade

I

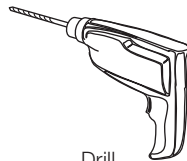

Drill

J

Sold Separately: 10 Tubes Waterproof Instant
Grab Adhesive: 3 Tubes Tub & Tile Sealant:
Additional 2x4 studs if installing optional
Aspirations Bath/Shower Door

INSTALLATION INSTRUCTIONS

IMPORTANT GENERAL INFORMATION

This unit is best installed by two people.

Cover drain with tape prior to installation to prevent the loss of small parts.

Unpack your unit carefully and inspect for freight damage. Lay out and identify all parts using Box Contents as a reference. Before discarding the carton check to see that no small hardware parts have fallen to the bottom of the box. If any parts are damaged or missing refer to the description noted in the instructions when inquiring about replacements.

Be sure to wear safety glasses whenever drilling or cutting. When drilling holes in ceramic tile or marble use a center punch and hammer to carefully break the glazed surface. This will prevent skidding when drilling.



BEFORE YOU BEGIN

Local building codes vary by location. Observe all local plumbing and building codes. Unpack your new shower walls and inspect them carefully for damage. Verify that the walls are the correct size for your installation. **NOTE: Take extra care in handling the front surfaces of the walls. Do not pull off the clear protective film until actual installation. Use only non-abrasive cloths to avoid scratching.**

PREPARATION



Do not install directly to studs.

Aspirations Bath/Shower Walls must be installed over a solid, water resistant substrate such as greenboard.

If alcove opening is larger than rough-in opening (see Illustration 1) there will be a visible gap between rear corners. Fir-out studding if necessary before installing substrate to provide correct alcove opening for panels. Ensure alcove is plumb and square.

1. ROUGH PLUMBING & FITTINGS MUST BE INSTALLED BEFORE WALLS

2. WALL SURFACE PREPARATION

Ensure wall surface is dry, smooth, and free of dust, soap scum, mold or other contaminants. Wipe wall surfaces with a damp cloth and allow to dry.

TIP: Priming wall substrate improves shower wall adhesion. Wall surface must be dry before panels can be applied.



SHOWER BASE SHOWN

NOTE: IF YOU PLAN TO INSTALL THE ASPIRATIONS BATH OR SHOWER DOOR, REFERENCE THE FIGURE FOR ADDITIONAL 2X4 SUPPORT PLACEMENT.

Follow manufacturer's instructions and prepare stud wall accordingly.

Required 2x4 Support for Aspirations Bath/Shower Door

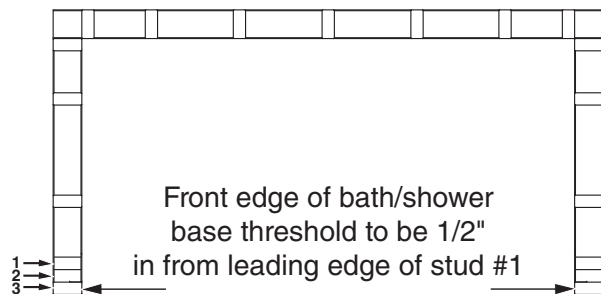

Required 2x4 stud support when installing Aspirations Bath/Shower Door.

INSTALLING REAR WALL PANELS

- Starting with the Right Rear Panel with exposed Under Lap Joint facing you (ref illustration 2), attach a Corner Trim Piece (ref illustration 3) to the opposite side of the panel and dry fit the combination of panel/trim piece to the right rear wall. **Note.** Use shims to keep a 1/8" gap above the deck of the shower base or bath.
- Dry fit the Right Rear Panel and Corner Trim squarely into the corner of the alcove. Some adjustment of the rear panel can be made to keep the panel 1/8" off the deck of bath or deck of base by moving the panel in or out from the Corner Trim if alcove is slightly out of square. If necessary the panel can be additionally cut and trimmed to fit within the alcove opening should the adjustment of the panel from the Corner Trim is not enough. Ensure the rear panel fully engages within the Corner Trim. (ref. Fig 3)

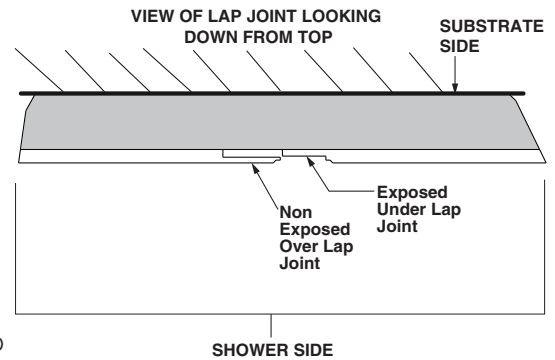

Illustration 2

Trimming Panels:

- Measure shower enclosure.
 - Apply masking tape to approximate cut area on the tile finished side to protect surface.
 - Transfer measurement to panel.
 - Using a jigsaw with a fine tooth blade, cut along line on finished tile side. Ensure a new blade is used.
- Once right rear panel is correctly dry fitted to the right rear wall, strike a vertical line top to bottom along the outer left edge of the exposed under lap joint as a reference on the wall when applying the adhesive once the panel is removed.

NOTE: Install one panel at a time.

- Wipe all panels and walls with a damp cloth to remove any dust or debris and allow to fully dry.
- Starting with the right rear panel that was correctly dry fitted first, apply 1/2" bead of adhesive on the substrate in evenly spaced horizontal strips every 6" for each panel top to bottom. Apply one row of adhesive horizontally to the top and bottom edges of the substrate. (Illustration 4) Also add adhesive along both sides in the corner of the alcove top to bottom 1/2" thick for Corner Trim.
- Move rear panel and Corner Trim onto the wall keeping a space of approximately 1/8" off the bottom surface of the shower base or bath. Press panel and Corner Trim firmly over entire surface to ensure firm contact of panel to adhesive on wall. Repeat Steps 1 to 6 for the opposite Rear Panel to dry fit, trim and apply adhesive.
- Apply waterproof construction adhesive to the Under and Over Lap Joint of both Left & Right Rear Panels. (Illustration 2) Place opposite rear panel in place on rear wall as in steps above. Wipe off excess adhesive with a damp cloth.

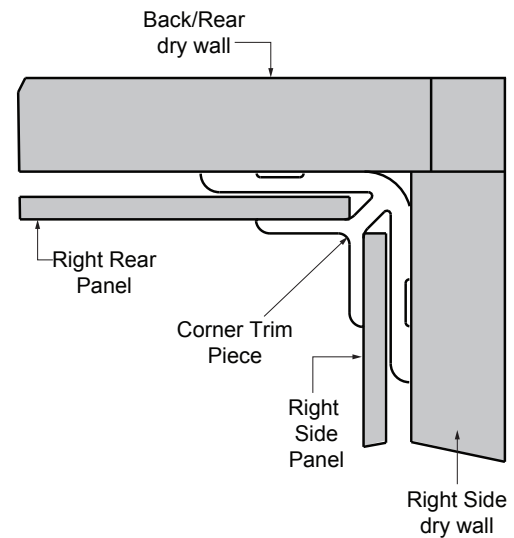

Illustration 3



Illustration 4

INSTALLING SIDE WALL PANELS

1. Orient both Left and Right Side Panels to the Rear Panels following illustrations 5. If installing Bath wall installation, follow that illustration. If installing Shower Wall installation, follow that illustration to keep grout lines in correct order.
2. Align grout lines of side panels with rear wall panel grout lines. Trim side panels if needed to fit within alcove area keeping panel 1/8" above deck of shower base or Bath. (Illustration 5) Trim or cut from bottom edge of side panels so that the top edge of the panels are level with the top edge of the back panels. Can also slide panel in or out of Corner Trim for additional adjustment of side wall panels.

Trimming Panels:

- a) Measure shower enclosure.
 - b) Apply masking tape to approximate cut area on the tile finished side to prevent chipping and protect surface.
 - c) Transfer measurement to panel.
 - d) Using a jigsaw with a fine tooth blade, cut along line on finished tile side. Ensure a new blade is used.
3. Once both side panels are properly dry fitted, and in the correct position, measure and mark all plumbing locations on the side panel with shower valve and shower head.
 4. Drill hole at each location using hole saws large enough to accommodate the opening but small enough to be covered by the trim plates. Dry fit and check alignment of hole locations. (Illustration 6)

NOTE: Drill from finished tile side.

⚠ Do not use wood/paddle bits or grit hole saws as they will chip.

5. Once both left and right side panels are dry fitted in the correct position, draw a line top to bottom on the outside edge of each panel to use as a reference for the adhesive once the panels are removed.
6. Wipe panels and walls with a damp cloth to remove any dust or debris. Allow to fully dry.
7. Apply 1/2" bead of adhesive on the substrate in evenly spaced horizontal strips every 6" for each panel, top to bottom. (Illustration 4) Apply one row of adhesive horizontally to the top and bottom edges of the substrate. (Illustration 4) Place side wall panel into groove of Corner Trim first and slowly press panel onto wall with adhesive keeping panel in correct position. Press firmly over entire surface to ensure adhesion. Wipe off excess adhesive with a damp cloth.
8. Repeat on second side wall panel.

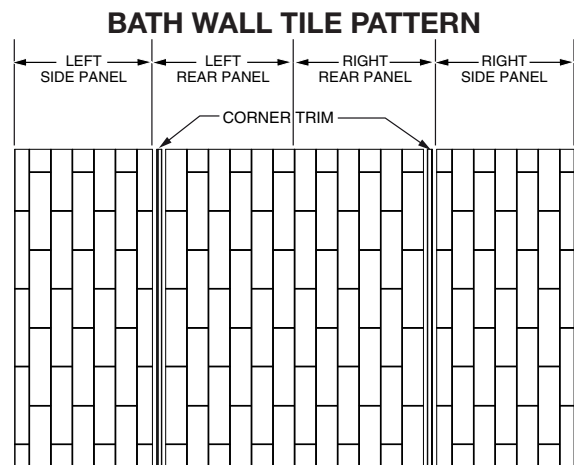
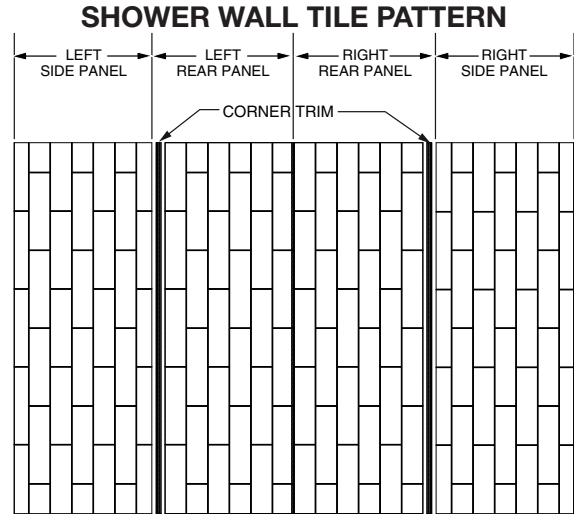

Illustration 5

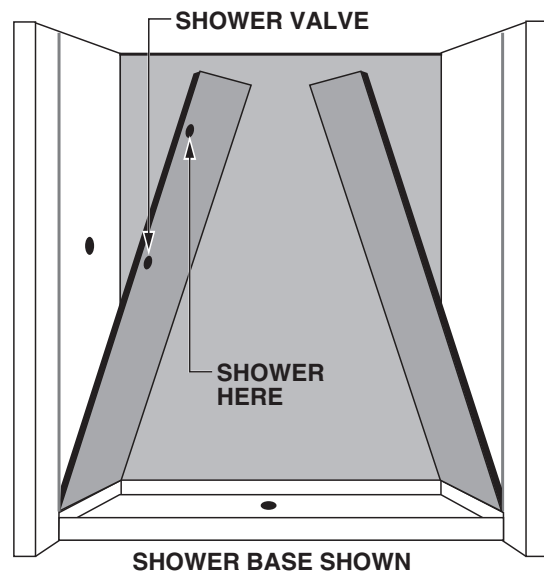



Illustration 6

4

APPLYING SEALANT FOR SEAMS AND JOINTS

1. Once all panels are securely in place and set, apply the tub and tile sealant to all areas and gaps between the bottom of walls and deck of shower base or bath and around outer edges of walls. (Illustration 7)

NOTE: Wipe any excess adhesive from the panel with damp cloth.

 Allow 24 hours for the sealant to dry before use.

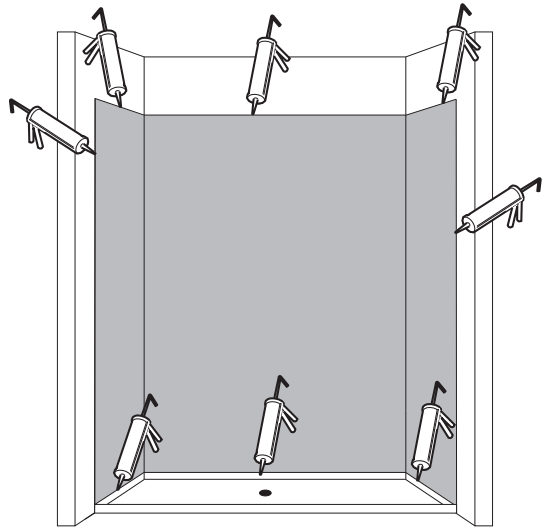

Illustration 7

POST INSTALLATION CLEAN-UP

Remove all construction debris. Install any accessories, shelves or doors according to manufacturer's installation instructions.

AFTERCARE AND CLEANING

⚠ WARNING: Cleaning products with labels that say "not suitable for use with ABS, acrylic or polystyrene" SHOULD NOT BE USED. Read all labels carefully.

Clean shower walls with warm soapy water and soft sponge. For stubborn stains, use a 50/50 mix of isopropyl alcohol and water.

HARSH CHEMICALS SHOULD NEVER BE USED ON SHOWER WALL SURFACE. Clean after use with a mild liquid household detergent cleaner. **Do not use** Lestoil®, Lysol® Disinfectant (spray or concentrate), or Lysol® Basin, Tub and Tile Cleaner, Windex®, Mr. Clean®, Dow® Disinfectant Bathroom Cleaner, or cleaning products in aerosol cans.

Do not use wire brushes, knives or sharp objects to remove stains or other surface blemishes.

Abrasive cleaners or powders should not be used as they will dull the surface.

Do not allow nail polish remover, acetone, paint remover or other solvents to come into contact with the surface.

TELL US WHAT YOU THINK!

Please leave us a product review or story
at **AmericanStandard.com/reviews**

Find installation videos at
youtube.com/americanstandard

Register your warranty and sign up for an idea-filled newsletter at
AmericanStandard-us.com/support/warranty

**PLEASE COMPLETE AMERICAN STANDARD WARRANTY REGISTRATION PROCESS AND
SAVE THIS WARRANTY INFORMATION IMPORTANT:**

Registration of the sink must be completed for this warranty to become effective. Your registration will make it easier to contact you in the event of a product recall.*

INSTRUCTIONS: Register your sink at www.americanstandard.com. Please save your proof of purchase (sale receipt). If you need assistance or do not have access to our website, please contact American Standard Customer Care at: (800) 442-1902. An American Standard representative will assist in completing the warranty registration.

*In California, your warranty rights remain intact even if you do not complete the registration process.

 **SHARE YOUR NEW PRODUCT!**

Tag us **@american_standard** on Instagram
and show us how your new product looks.

 **WANT MORE INFO?**

For questions or help call us at **855-815-0004**,
or visit **AmericanStandard.com**

UNITED STATES

American Standard Brands
865 Centennial Ave.
Piscataway, New Jersey 08854
Attention: Director of Customer Care
For residents of the United States,
warranty information may also be
obtained by calling the following
toll free number: (855) 815-0004
www.AmericanStandard.com

CANADA

LIXIL Canada, Inc.
5900 Avebury Rd.
Mississauga, Ontario
Canada L5R 3M3
Toll Free: (800) 387-0369
AmericanStandard.ca/support/warranty

MEXICO

American Standard B&K Mexico
S. de R.L. de C.V.
Via Morelos #330
Col. Santa Clara
Ecatepec 55540 Edo. Mexico
Toll Free: 800-839-1200
AmericanStandard.com.mx/garantia

756255-100 EN (11/23)
2951SWT32/2952BWT32/2951SWT48/2951SWT36/2952BWT36

PART OF **LIXIL**

American Standard