

# V135 3-Way Mixing or Diverting Valve

**PRODUCT DATA**



**Maximum Differential Pressure:** 147 psi.

**Stroke Length:** 0.08 in. (2 mm)

**Cv rating and valve size:** See Table 1.

**Table 1. Flow Capacities.**

Size (in.)	Cv Factor <sup>a</sup>
3/4	3.7
1	5.8
1-1/4	5.8
1-1/2	11.7

<sup>a</sup> Cv= U.S. GPM at 1psi differential pressure.

## APPLICATION

The Honeywell Braukmann V135 valve is designed for hydronic heating systems and can be applied as a mixing valve or a diverting valve. The V135 is normally used with the T100R series thermostatic control, which is equipped with a strap-on pipe sensor for attaching to the heating system pipe by means of a clamp. A plastic handle is also provided with the V135 for manual operation of the valve.

## SPECIFICATIONS

### Construction

Body of bronze, internal parts of high-quality engineering plastic, stainless steel stem and high-quality elastomer materials.

**Maximum Temperature Rating:** 248 °F (120 °C)

**Maximum System Pressure:** 232 psi.

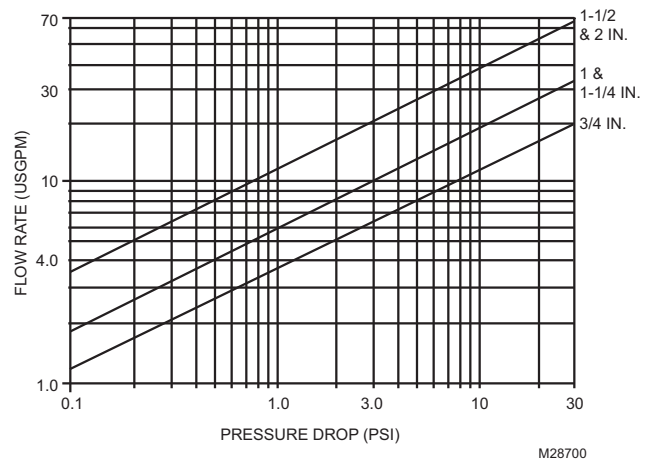

**Fig. 1. V135A flow chart.**

**Dimensions:** See Fig. 2 and Table 2.

V135 3-WAY MIXING OR DIVERTING VALVE

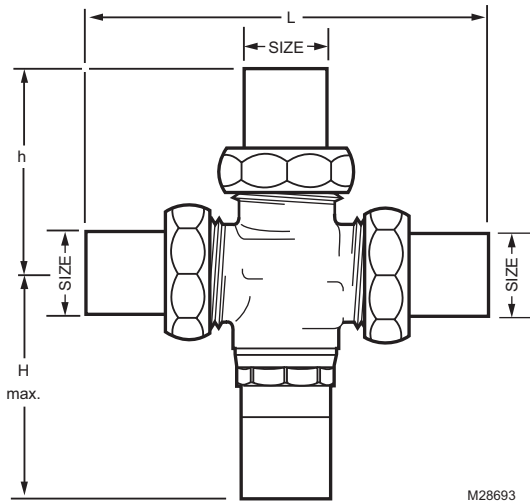

Fig. 2. V135A dimensions in in. (mm).

Table 2. V135 Dimensions in in. (mm).

Item Number	Size (in.)	L	H max.	h
V135A1006	3/4	5-1/8 (128)	3-1/4 (83)	2-9/16 (64)
V135A1014	1	5-13/16 (148)	3-1/4 (83)	2-15/16 (74)
V135A1063	1-1/4	6-3/8 (162)	3-1/4 (83)	3-3/8 (86)
NPT Threaded Union				
V135A1022	1-1/4	7-1/8 (180)	3-1/4 (83)	3-3/4 (95)
V135A1048	1-1/2	8-5/16 (211)	3-11/16 (94)	4-3/16 (106)

## REPLACEMENT PARTS

Table 3. Replacement Parts.

Description	Part Number
<b>Cartridges</b>	
3/4 in. valve	V135A-12VE
1 in. and 1-1/4 in. valves	V135A-1VE
1-1/2 in. valve	V135A-11/2VE
<b>Gaskets (packages of 10)</b>	
1/2 and 3/4 in. valves	0901444
1 in. valve	0901445
1-1/4 in. valve	0901446
1-1/2 in. valve	0901447
Plastic handle for manual shutoff	H100-1/2A

## INSTALLATION

### When Installing This Product...

1. Read these instructions carefully. Failure to follow them could damage the product or cause hazardous conditions.
2. Before installation, make sure that the inside of the valve is clean and free of any packing materials, etc. The supply line should be flushed out to clear of any sediment, scale, or foreign material.
3. Installation as a mixing valve:

After re-installation, the bushing should be adjusted flush with the metal cartridge rim.

## APPLICATION DIAGRAMS

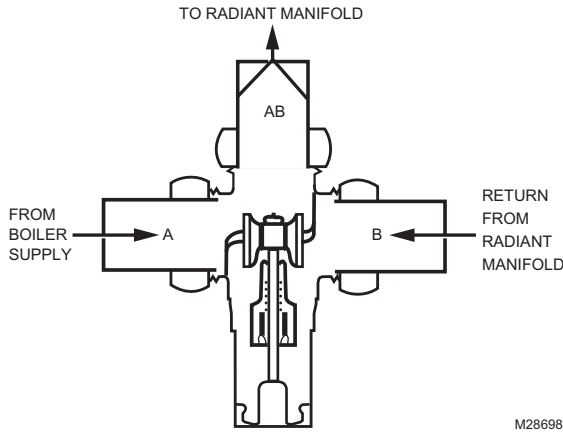

M28698

Fig. 3. Installation as a mixing valve.

### 4. Installation as a diverting valve:

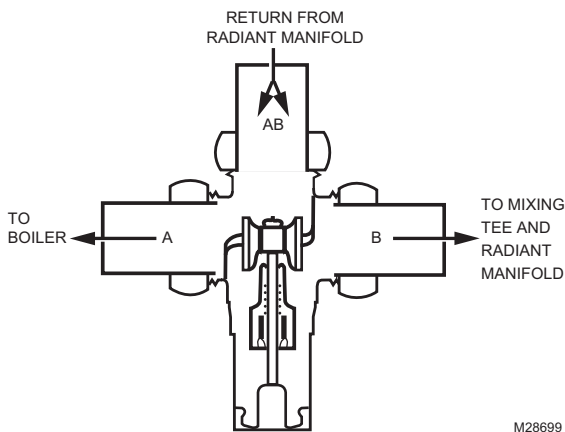

M28699

Fig. 4. Installation as a diverting valve.

## SERVICE TIPS

The Honeywell Braukmann 3-way valve has a double “stem seal” arrangement. The outer bushing with O-rings may be replaced under pressure and without draining the system.

An ordinary screwdriver is required to remove the bushing, as shown in Fig. 5.

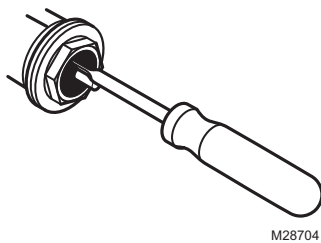

M28704

Fig. 5. Removing the bushing with a screwdriver.

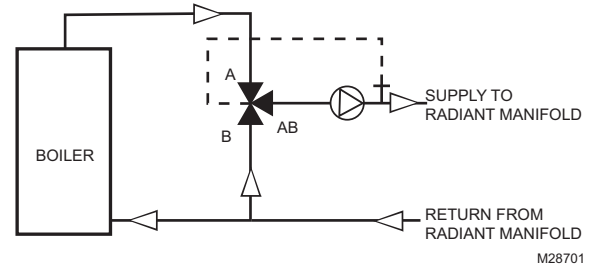

M28701

Fig. 6. Typical mixing valve application.

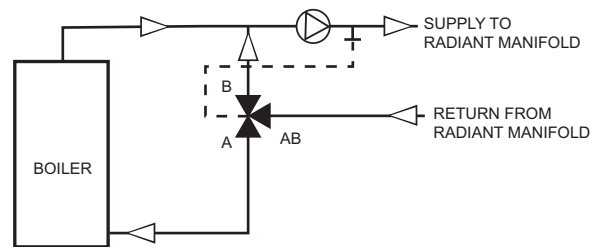

M28702

Fig. 7. Typical diverting valve application.

NOTE: These diagrams are intended to show general arrangement only. Consult local codes for complete piping requirements.

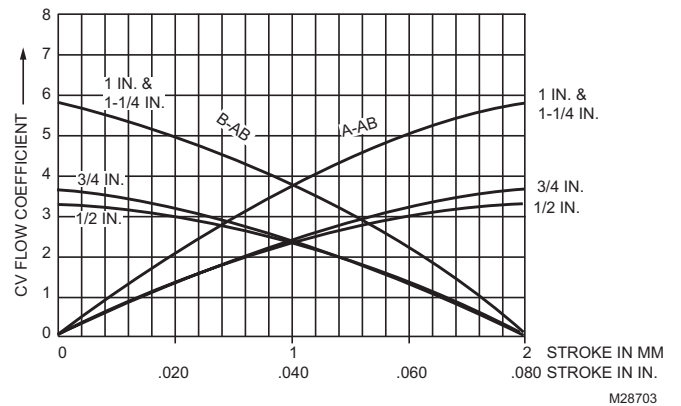

M28703

Fig. 8. Diagram for flows from A-AB and B-AB.

**Automation and Control Solutions**

Honeywell International Inc.  
1985 Douglas Drive North  
Golden Valley, MN 55422

Honeywell Limited-Honeywell Limitée  
35 Dynamic Drive  
Toronto, Ontario M1V 4Z9  
[customer.honeywell.com](http://customer.honeywell.com)

® U.S. Registered Trademark  
© 2010 Honeywell International Inc.  
95C-10711-01 M.S. Rev. 07-10  
Printed in U.S.A.

**Honeywell**