

TEMP/GUARD®

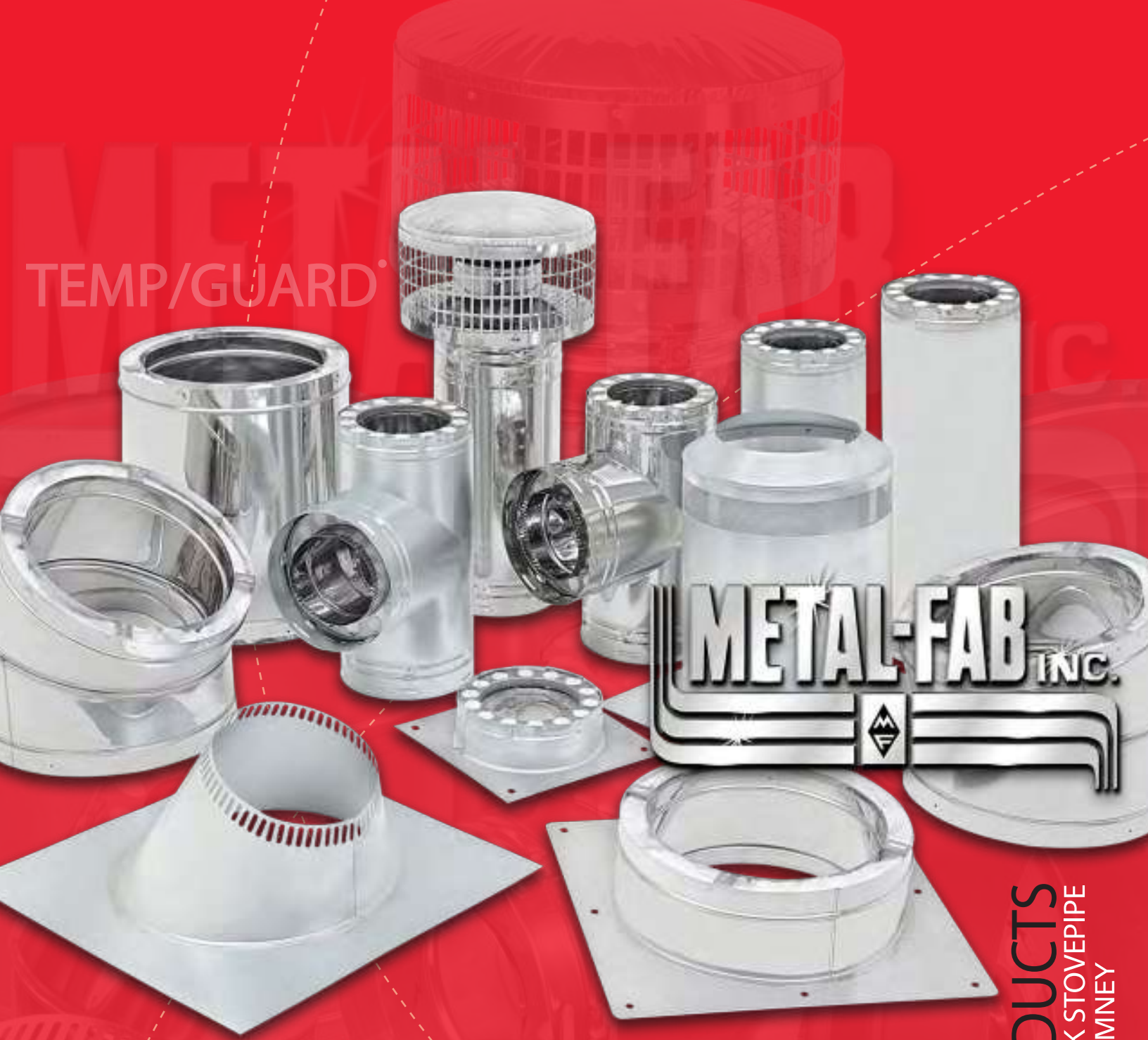

METAL-FAB INC.

BLACK STOVE PIPE

SOLID FUEL

AIR-COOLED

FOR USE WITH WOOD, COAL, OIL OR GAS-FIRED APPLIANCES

SOLID FUEL PRODUCTS
TEMP/GUARD® CHIMNEY • BLACK STOVEPIPE
AIR-COOLED TEMP/GUARD® CHIMNEY

TEMP/GUARD INTERIOR - NO OFFSET

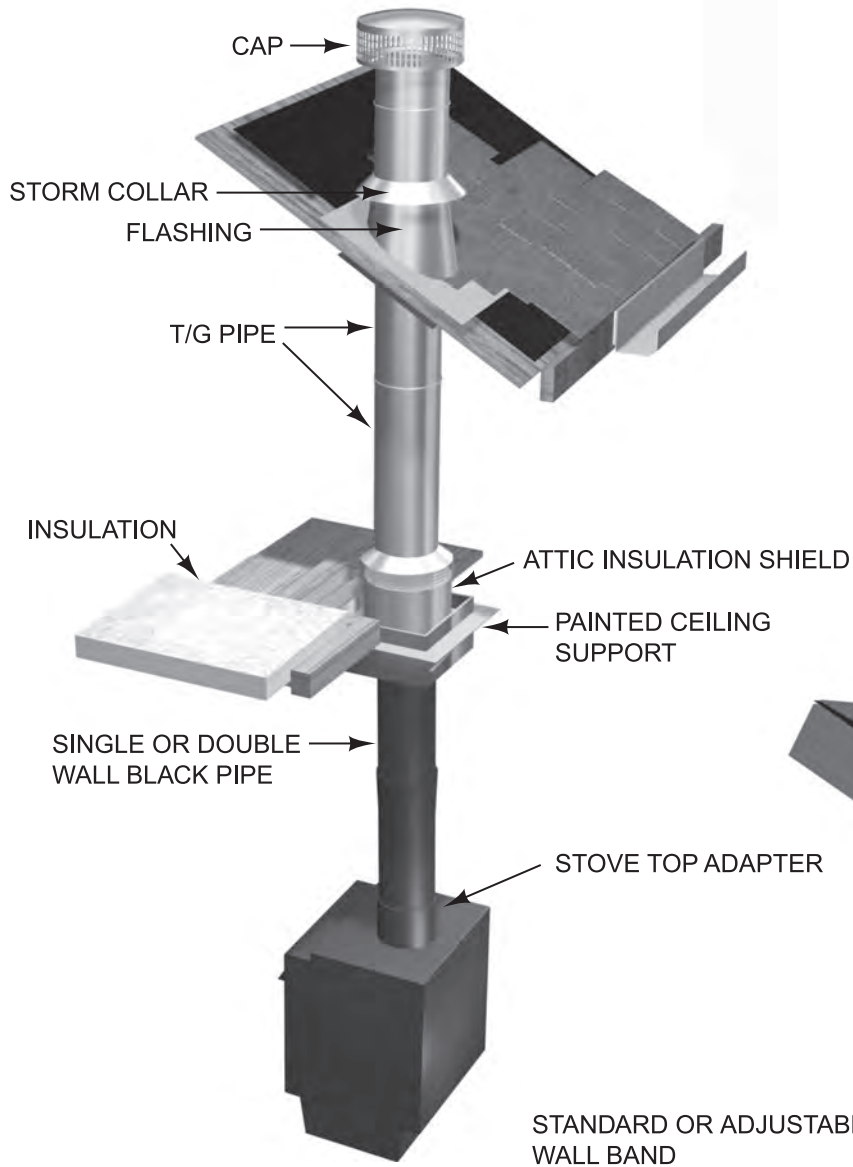

TEMP/GUARD EXTERIOR

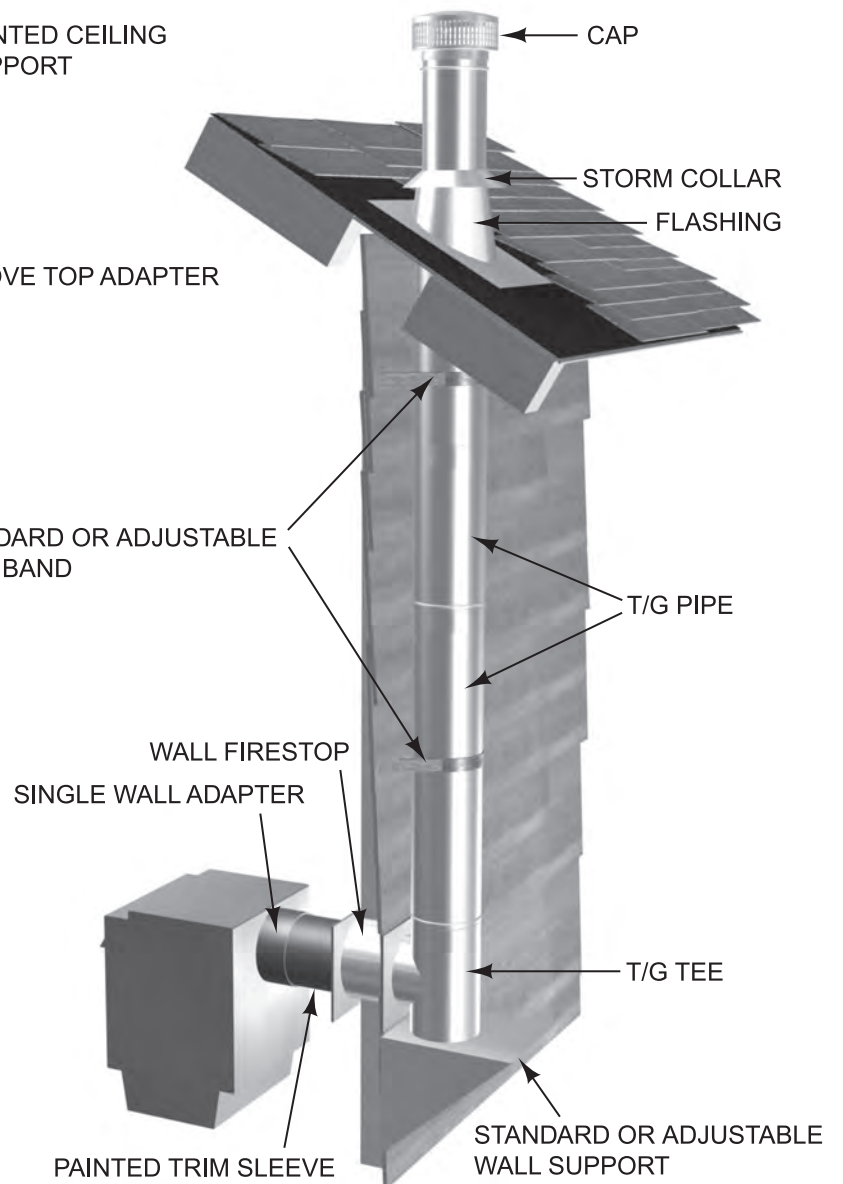

TEMP/GUARD PITCHED CEILING

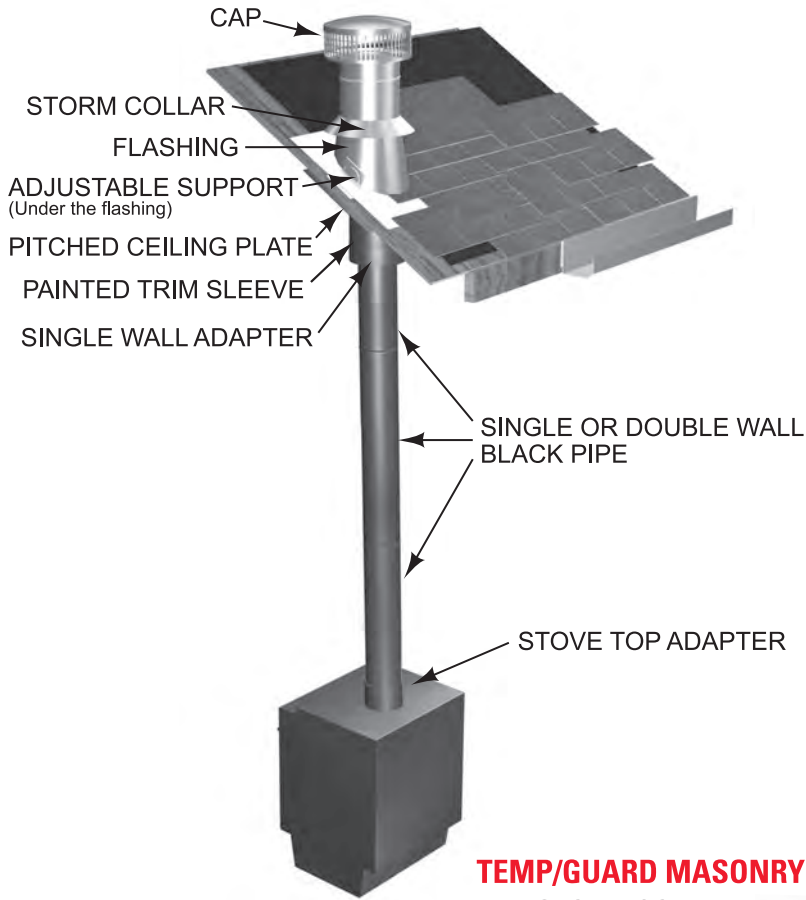

TEMP/GUARD HIGH-PITCHED CATHEDRAL CEILING

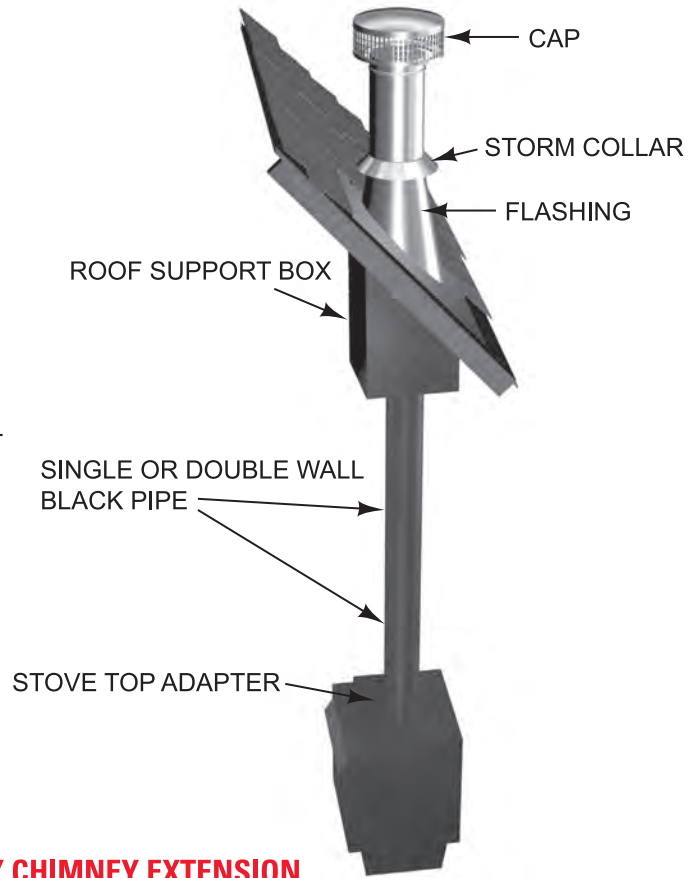

TEMP/GUARD MASONRY CHIMNEY EXTENSION

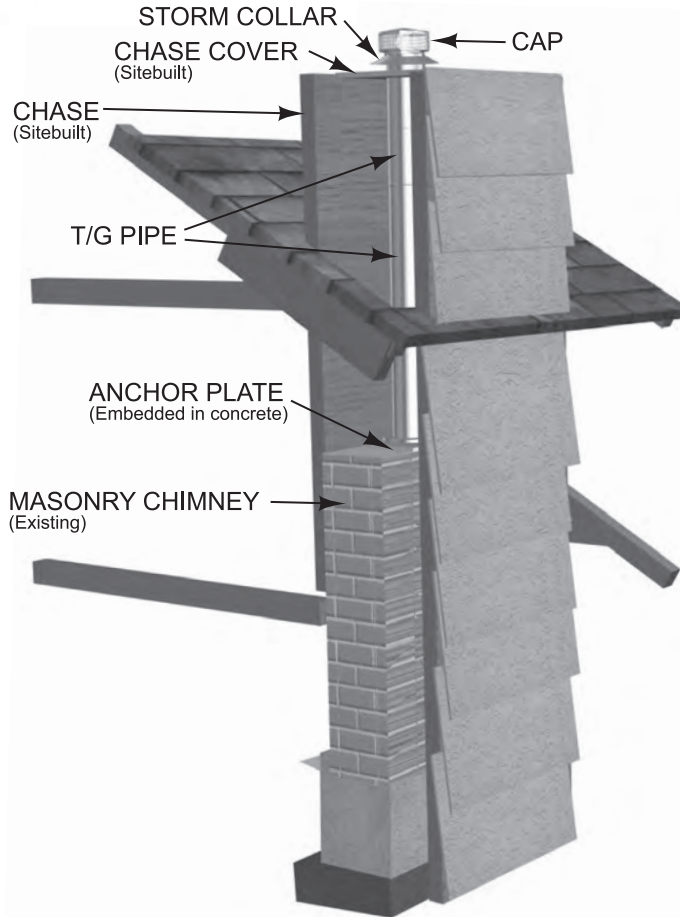

Note: Twist Lock Pipe (6"-12") overlaps 1½" when joined together. Quick Connect Lock (14"-18") overlaps 1½" when joined together with sheet metal screws. Therefore, assembled length on all sizes is 1½" less than listed length.

Temp/Guard® All-Fuel Chimneys

Double-wall, factory-built type for use with listed wood, coal, oil or gas-fired appliances.



- Temp/Guard Max is the only all-fuel chimney that is UL Listed for 1½" clearance to combustibles on 6", 7", and 8" diameters.
- Temp/Guard (10"-18") is tested and listed for a minimum clearance to combustibles of 2".
- Sizes 6", 7", 8", 10" and 12" are listed by Underwriters Laboratories Inc. to UL Standard 103HT (2100° intermittent; 1000° continuous).
- Sizes 14", 16" and 18" are listed by Underwriters Laboratories Inc. to UL Standard 103 (1700°F intermittent; 1000°F continuous).
- Sizes 6", 7" and 8" are listed by Underwriters Laboratories Inc. to ULC-S629 for use in Canada (see separate installation instructions; literature number L2686).
- The S.S. flue conduit is wrapped with ceramic insulating material.
- Limited Lifetime Warranty



- **Application Reminder:** For oil or coal burning appliances, use only pipe with S.S. casing and S.S. or Aluminum accessory components outside the envelope of the building.
- **Appliance Caution:** Temp/Guard is intended for use in residential and building heating appliances that operate at continuous temperatures below 1000° F.

CHIMNEY PIPE – 6" - 12" TGS (Stainless Casing) and TGG (Galvanized Casing)

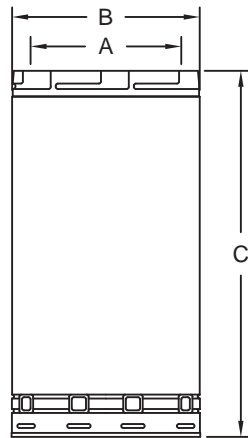

SIZE	6"	7"	8"	10"	12"
A	6.00"	7.00"	8.00"	10.00"	12.00"
B	9.00"	10.00"	11.00"	13.00"	15.00"
C	6, 12, 18, 24, 36, and 48* inch lengths				

*48" lengths of 10" and 12" not available

The outer casing of stainless or galvanized provides strength, durability, and corrosion resistance. Twist lock enables fast, easy installation, without tools. **Always use TGS for exterior pipe in oil applications.**

CHIMNEY PIPE – 14" - 18" TG (Aluminized Outer Casing)

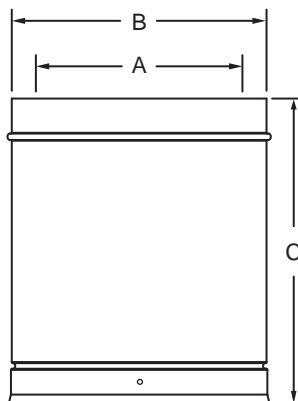

- Notes:
- (1) 14", 16", 18" listed to 1700°F intermittent; 1000°F continuous.
 - (2) Quick Connect Lock using sheet metal screws.

SIZE	14"	16"	18"
A	14.00"	16.00"	18.00"
B	17.00"	19.00"	21.00"
C	12, 18, 36, & 48 inch lengths		

Note: Twist Lock Pipe overlaps 1½" when joined together. Therefore, assembled length is 1½" less than listed length.

INSULATED TEE – 6" - 12" TGST (Stainless Casing) and TGGT (Galvanized Casing)

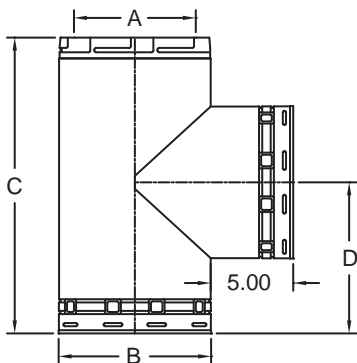

SIZE	6"	7"	8"	10"	12"
A	6.00"	7.00"	8.00"	10.00"	12.00"
B	9.00"	10.00"	11.00"	13.00"	15.00"
C	17.50"	18.50"	19.50"	21.50"	23.50"
D	9.50"	10.00"	10.50"	11.50"	12.50"

The chimney tee may be used to support the chimney indoors or outdoors on the non-combustible wall support or masonry pier. A standard tee cap (TGTC) ships with the tee.

Note: Insulated Tee - 10" - 12" galvanized casing only. 14", 16", and 18" components are intended for use on chimney extensions only.

TEE CAP – 6" - 12" TGTC



Ships with 6" - 12" tee, or may be ordered separately.

INSULATED TEE CAP – 6" - 8" TGITC

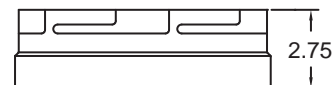

For installations close to combustibles, this insulated tee cap may be ordered separately. Not for use on a tee support.

15° ANGLE – 6" - 12" TGSA15 (Stainless Casing) and TGA15 (Galvanized Casing)

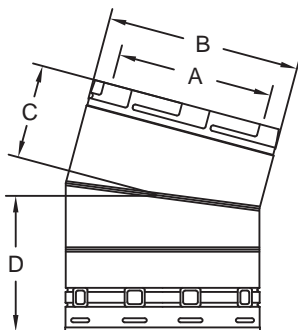

SIZE	6"	7"	8"	10"	12"
A	6.00"	7.00"	8.00"	10.00"	12.00"
B	9.00"	10.00"	11.00"	13.00"	15.00"
C	3.75"	3.75"	3.75"	3.75"	3.75"
D	6.40"	6.40"	6.40"	6.40"	6.40"

15° angles are used in pairs to obtain lateral movement around obstructions or to locate the chimney closer to the ridge.

15° angles in 10" & 12" available with galvanized casing only.

NOTE: See installation instructions for offset chart.

15° ANGLE – 14" - 18" TGA15 (Aluminized Outer Casing)

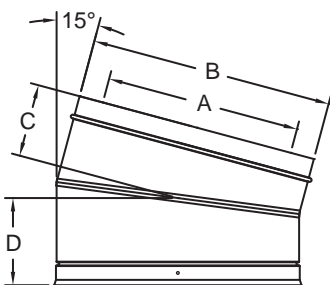

SIZE	14"	16"	18"
A	14.00"	16.00"	18.00"
B	17.00"	19.00"	21.00"
C	5.13"	5.25"	5.40"
D	6.13"	6.25"	6.40"

15° angles are used in pairs to obtain lateral movement around obstructions or to locate the chimney closer to the ridge.

NOTE: See installation instructions for offset chart.

Note: Twist Lock Pipe overlaps 1½" when joined together. Therefore, assembled length is 1½" less than listed length.

30° ANGLE – 6" - 12" TGSA30 (Stainless Casing) and TGGA30 (Galvanized Casing)

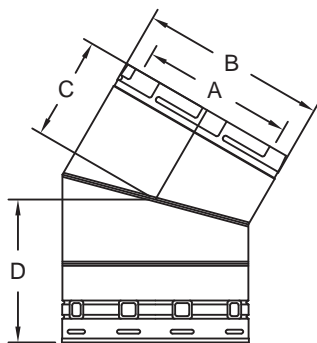

SIZE	6"	7"	8"	10"	12"
A	6.00"	7.00"	8.00"	10.00"	12.00"
B	9.00"	10.00"	11.00"	13.00"	15.00"
C	4.75"	4.75"	4.75"	4.75"	4.75"
D	6.75"	6.75"	6.75"	6.75"	6.75"

30° angles are used in pairs to obtain lateral movement where more angle is required.

30° ANGLE – 14 - 18" TGA30 (Aluminized Outer Casing)

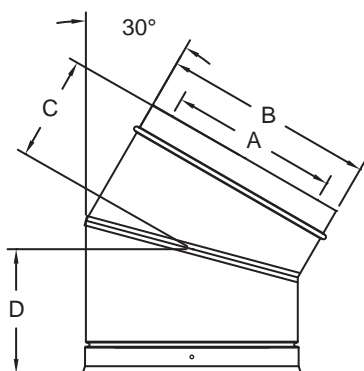

SIZE	14"	16"	18"
A	14.00"	16.00"	18.00"
B	17.00"	19.00"	21.00"
C	6.25"	6.50"	6.81"
D	7.25"	7.50"	7.81"

30° angles are used in pairs to obtain lateral movement where more angle is required.

PAINTED CEILING SUPPORT – TGCSF

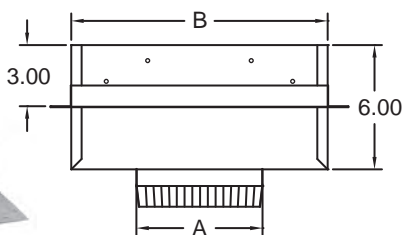
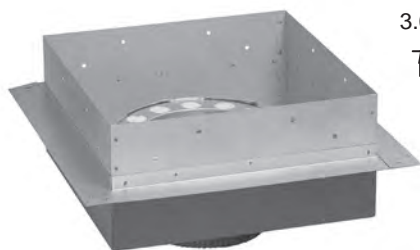

SIZE	6"	7"	8"	10"	12"
A	6.00"	7.00"	8.00"	10.00"	12.00"
B	12.44"	13.44"	14.44"	17.00"	19.00"
Flange Width is 1½"					

The black ceiling support is designed to support the chimney from the floor or ceiling joists. 6", 7", and 8" chimney fits between 16" O.C. joists with required clearance. Single wall adapter is part of support assembly.

PAINTED CEILING SUPPORT TRIM – TGCST

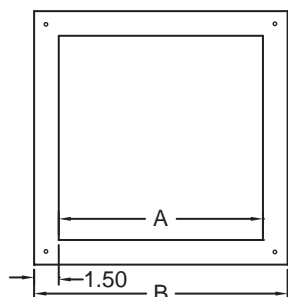

SIZE	6"	7"	8"	10"	12"
A	12.63"	13.63"	14.63"	17.19"	19.19"
B	15.63"	16.63"	17.63"	20.19"	22.19"

The black trim piece is used to trim off the ceiling support (TGCSF) if ceiling drywall has covered the built-in support box trim on new construction.

DELUXE CEILING SUPPORT – 6" and 8" TGDLS

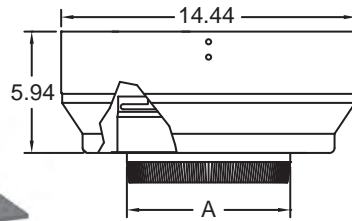

SIZE	6"	8"
A	6.00"	8.00"

The deluxe support provides round "barrel" design. The "barrel" has Temp/Guard pipe adapter built into it. Comes with both round and square trim plates (square plate shown).

WALL SUPPORT/ADAPTER – FIXED – TGWS

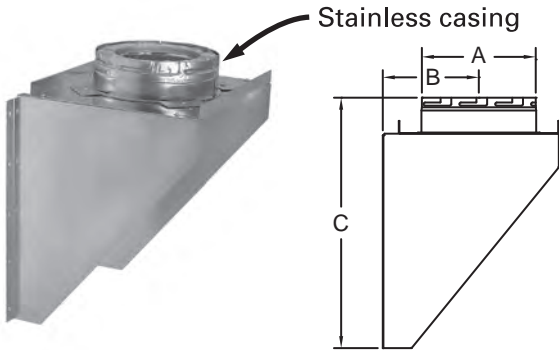

SIZE	6"	7"	8"	10"	12"
A	9.00"	10.00"	11.00"	13.00"	15.00"
B	6.50"	7.00"	7.50"	8.50"	9.50"
C	16.50"	16.50"	16.50"	20.50"	20.50"

Mounting spacing is 16" O.C. for all sizes. This fixed spacing wall support is designed for use with the insulated tee to provide support for the chimney which has a lateral connection passing through the combustible wall. Support allows access from below to tee cap. The maximum height of chimney which may be supported is 60 ft.

Note: Available in stainless steel, please contact factory.

WALL SUPPORT/ADAPTER – ADJUSTABLE – TGAWS

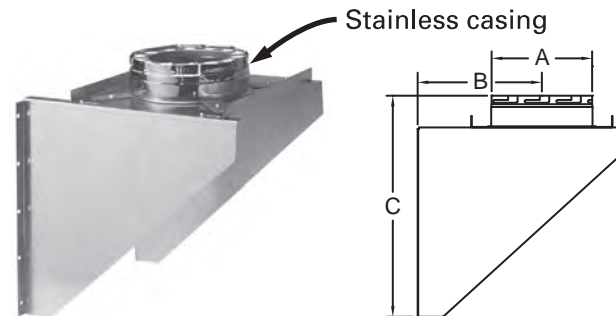

SIZE	6"	7"	8"
A	9.00"	10.00"	11.00"
B	5.00"-11.00"	5.00"-11.50"	5.00"-13.50"
C	19.50"	19.50"	19.50"

The adjustable support enables adjustments in clearance to combustibles from 2" - 8.50".

Note: Available in stainless steel, please contact factory.

ANCHOR PLATE – 6" - 12" TGAP

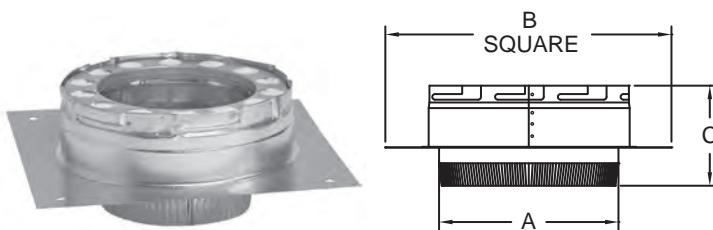

SIZE	6"	7"	8"	10"	12"
A	6.00"	7.00"	8.00"	10.00"	12.00"
B	12.00"	13.00"	14.00"	16.00"	18.00"
C	4.75"	4.75"	4.75"	3.75"	3.75"

The stainless steel anchor plate provides a positive connection to the smoke chamber on top of the masonry fireplace. 6" - 12" also used with chimney tee on masonry pier.

ANCHOR PLATE – 14" - 18" TGAP

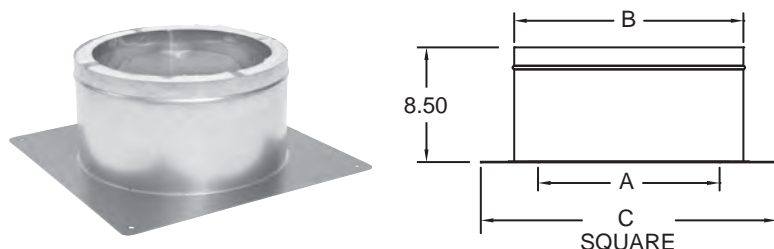

SIZE	14"	16"	18"
A	14.00"	16.00"	18.00"
B	17.00"	19.00"	21.00"
C	22.00"	24.00"	26.00"

SUPPORT BAND – 6" - 16" TGSB

Note: Use with TG and ATG

SIZE	6"	7"	8"	10"	12"	14"	16"
A	9.00"	10.00"	11.00"	13.00"	15.00"	17.00"	19.00"

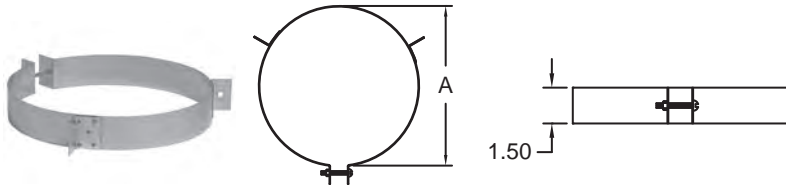

The support band is for use on installations where additional support is needed above the roof. Thin wall conduit or guy wire is to be attached to the band.

Note: Available in stainless steel, please contact factory.

ROOF BRACE – 6" - 8" TGRB

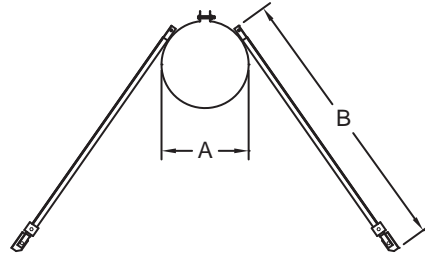

SIZE	6"	7"	8"
A	9.00"	10.00"	11.00"
B	Adjustable from 32" to 60"		

The roof brace kit includes support band, two braces, and mounting feet. Needed when more than 4 ft. of chimney extends above the roof.

WALL BAND – 6" - 18" TGWB

Note: Use with TG and ATG

SIZE	6"	7"	8"	10"	12"	14"	16"	18"
A	9.00"	10.00"	11.00"	13.00"	15.00"	17.00"	19.00"	21.00"
B	6.50"	7.00"	7.50"	8.50"	9.50"	10.50"	11.50"	12.50"
C	16.00"	16.00"	16.00"	16.00"	17.50"	18.00"	20.00"	22.00"

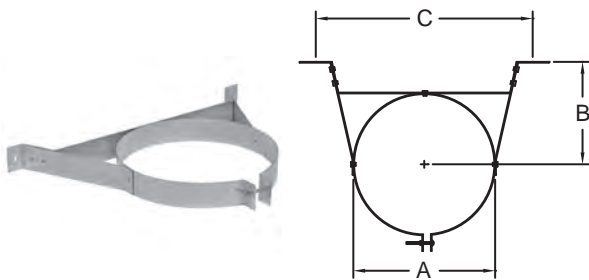

The wall band is used to secure the chimney to the wall, providing lateral stability and maintaining the proper clearance for the chimney pipe. The recommended spacing is 8 ft. between bands above the starting point.

Note: Available in stainless steel, please contact factory.

WALL BAND ADJUSTMENT KIT – TGWBA – KIT FITS 6", 7" AND 8"

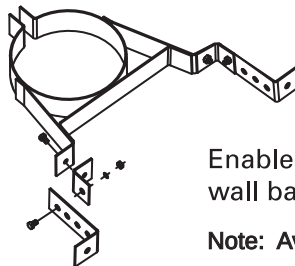

Enables adjustment of standard wall band (TGWB) from 2" - 6"

Note: Available in stainless steel, please contact factory.

ROOF SUPPORT W/TRIM – 6" - 12" TGRS

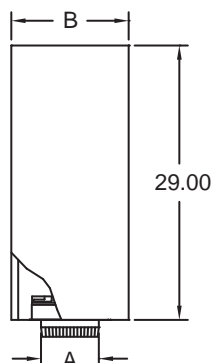

SIZE	6"	7"	8"	10"	12"
A	6.00"	7.00"	8.00"	10.00"	12.00"
B	12.44"	13.44"	14.44"	17.00"	19.00"

For use on open beamed pitched roofs or ceilings. Includes trim pieces for finishing out installation. Also includes integral single wall adapter. Will support 20 ft. of pipe.

ADJUSTABLE SUPPORT – 6" - 12" TGAS

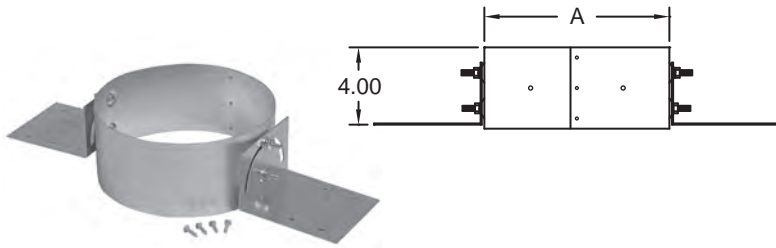

SIZE	6"	7"	8"	10"	12"
A	9.10"	10.10"	11.10"	13.10"	15.10"

Adjustable support fits all roof pitches and requires only simple framing. Can support 30 ft. of pipe. Trim with pitched ceiling plate of correct pitch.

PITCHED CEILING PLATE – 6" - 8" TGPCP

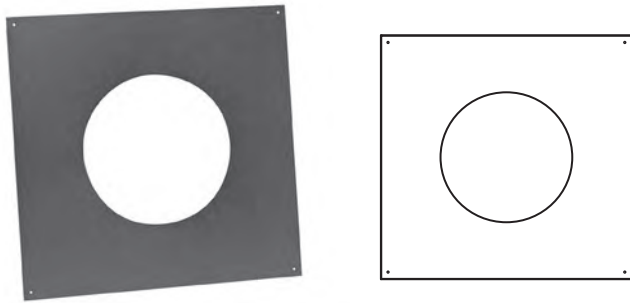

Used when pipe is supported by the TGAS. The oval I.D. of this plate covers any gap left between the chimney pipe and the ceiling. Select the plate which corresponds with the ceiling pitch. I.D. sized to fit over trim sleeve (TGTS).

Available pitches:
2/12; 4/12; 6/12; 8/12; & 10/12

PAINTED TRIM SLEEVE – 6" - 8" TGTS

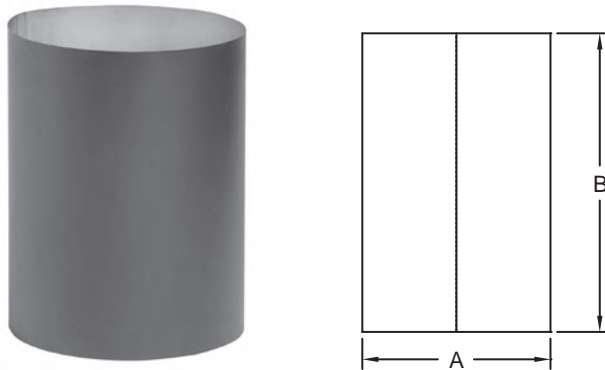

SIZE	6"	7"	8"
A	9.06"	10.06"	11.06"
B	12.00"	12.00"	12.00"

This cylinder slides over O.D. of TG pipe that protrudes through the wall or ceiling. It provides a uniform, finished appearance.

SINGLE WALL ADAPTER – 6" - 8" TGPSWA (Painted) & 10" - 12" TGSWA (Unpainted)

Also used as double wall black adapter.

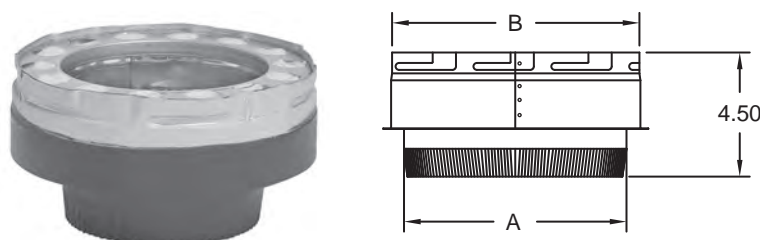

SIZE	6"	7"	8"	10"	12"
A	6.00"	7.00"	8.00"	10.00"	12.00"
B	9.00"	10.00"	11.00"	13.00"	15.00"

The single wall adapter is used to provide transition from single wall pipe to Temp/Guard chimney pipe.

*10" & 12" are unpainted.

FIRESTOP ASSEMBLY – TGFSA

SIZE	6"	7"	8"	10"	12"	14"	16"	18"
A	15.88"	16.88"	17.88"	21.00"	23.00"	19.00"	21.00"	23.00"
B	12.94"	13.94"	14.94"	16.94"	18.94"	21.00"	23.00"	25.00"
C	1.00"	1.00"	1.00"	1.00"	1.00"	25.00"	27.00"	29.00"

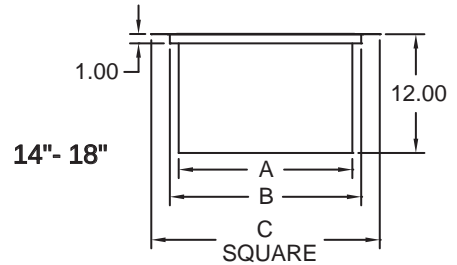
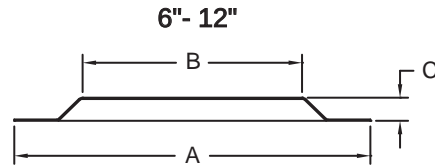

WALL FIRESTOP – 6" - 12" TGWFSP

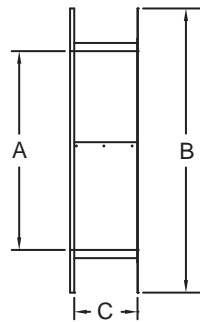

SIZE	6"	7"	8"	10"	12"
A	9.13"	10.13"	11.13"	13.13"	15.13"
B	17.00"	18.00"	19.00"	21.00"	23.00"
C	4.00" to 7.50"				

Wall firestop is used to provide the proper clearance for the chimney pipe when passing through a combustible wall.

INSULATION SHIELD – 6" - 12" TGIS

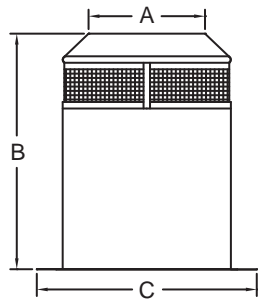

SIZE	6"	7"	8"	10"	12"
A	9.00"	10.00"	11.00"	13.00"	15.00"
B	18.00"	18.00"	18.00"	18.00"	18.00"
C	17.00"	18.00"	19.00"	21.00"	23.00"

Insulation shield must be used anytime the chimney system passes through an attic. TGIS is used to prevent the insulation from coming in contact with the pipe. This part is required on **any** attic pass-through situation, regardless if insulation is present or not.

Note: 14" - 18" insulation shield is not available, attic installation is not intended for these sizes.

RADIATION SHIELD – 8" - 18" TGRSH

Note: Use with TG and ATG

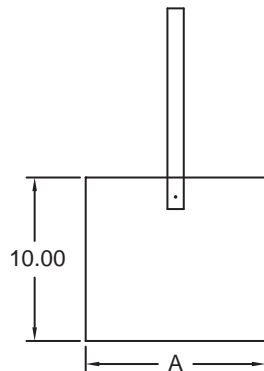

SIZE	8"	10"	12"	14"	16"	18"
A	13.00"	15.00"	17.00"	19.00"	21.00"	23.00"

12"-18"

Used on Temp/Guard

8"-16"

Used on Air-Cooled Temp/Guard

Radiation shield is required when 12" and larger diameter chimney pipe passes through a roof.

Note: Available in stainless steel, please contact factory.

STAINLESS CAP/SPARK ARRESTER – 6" - 12" TGC

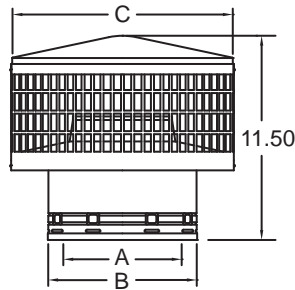

SIZE	6"	7"	8"	10"	12"
A	6.00"	7.00"	8.00"	10.00"	12.00"
B	9.00"	10.00"	11.00"	13.00"	15.00"
C	13.50"	13.50"	15.50"	19.13"	19.13"

The contemporary spark arrester cap also guards against rain, snow and down drafts, and helps provide proper venting action.

STAINLESS CAP/ SPARK ARRESTER – 14" - 18" TGC

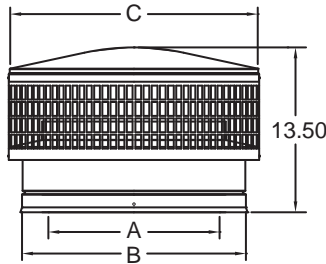

SIZE	14"	16"	18"
A	14.00"	16.00"	18.00"
B	17.00"	19.00"	21.00"
C	19.13"	21.00"	24.00"

STAINLESS DETACHABLE CAP – 6" - 8" TGDC

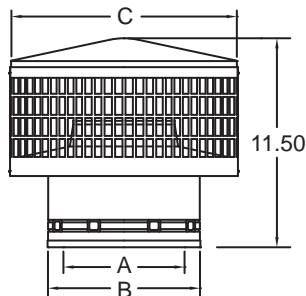

This cap is similar to TGC, but is produced without twist locking buttons. Cap slips onto pipe and is attached with packaged screws. Easily removed for cleaning. See TGC size chart.

STAINLESS CAP (Rain Cap) – 6" - 12" TGRC

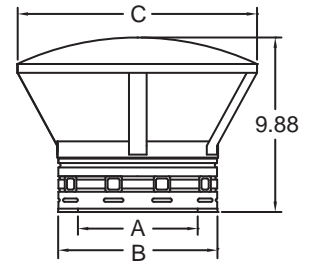

SIZE	6"	7"	8"	10"	12"
A	6.00"	7.00"	8.00"	10.00"	12.00"
B	9.00"	10.00"	11.00"	13.00"	15.00"
C	13.50"	13.50"	15.50"	19.13"	19.13"

**STORM COLLAR – 6" - 8" TGSC and TGASC (Aluminum)
10" - 12" TGSC and TGSSC (Stainless)
14" - 18" TGSC (Galvanized)**

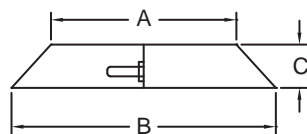

SIZE	6"	7"	8"	10"	12"	14"	16"	18"
A	9.00"	10.00"	11.00"	13.00"	15.00"	17.00"	19.00"	21.00"
B	18.00"	18.00"	19.50"	21.50"	23.50"	25.50"	27.50"	29.50"
C	3.18"	3.18"	3.18"	3.18"	3.18"	4.25"	4.25"	4.25"

Note: Aluminum or stainless steel materials are recommended for oil and coal applications.

DEAD SOFT ALUMINUM FLASHING – 6" and 8" TGDSF

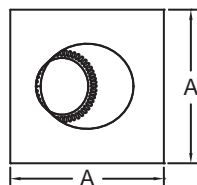

Fits roof pitch from 2/12 to 5/12

SIZE	6"	8"
A	22.25"	24.00"

For use with metal, corrugated and tile applications.

PITCHED ROOF FLASHINGS

FLASHING – TGF or TGAF
Fits roof pitch from 2/12 to 5/12.

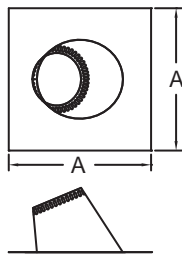

SIZE	A
6"	22.25"
7"	24.00"
8"	24.00"
10"	26.75"
12"	29.00"

FLASHING – TGF10 or TGAF10
Fits roof pitch from 6/12 to 10/12.

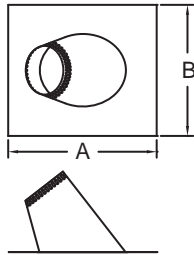

SIZE	A	B
6"	28.50"	23.50"
8"	30.75"	25.25"
*10"	35.35"	28.75"
*12"	37.50"	30.25"

Note: Available in galvanized only.

FLASHING – TGF15 or TGAF15
Fits roof pitch from 11/12 to 15/12.

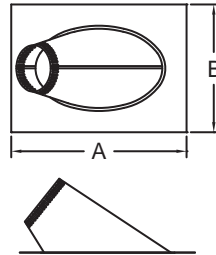

SIZE	A	B
6"	28.88"	21.00"
7"	30.50"	22.00"
8"	35.75"	28.50"
10"	38.40"	27.00"
12"	41.60"	29.00"

FLASHING – TGF24 or TGAF24
Fits roof pitch from 16/12 to 24/12.

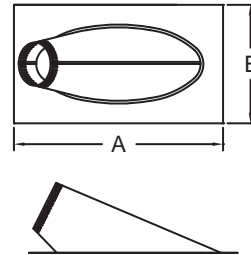

SIZE	A	B
6"	38.00"	23.00"
8"	43.50"	25.70"



NOTE: Aluminum option material is recommended for oil and coal applications.

FLAT ROOF FLASHINGS

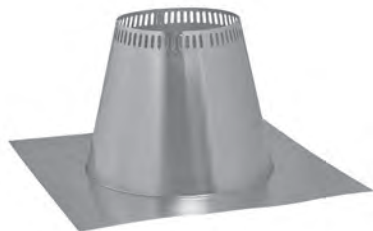

FLAT TALL CONE FLASHING – 6" - 8" TGFT OR TGAFT 10"-12" TGFT

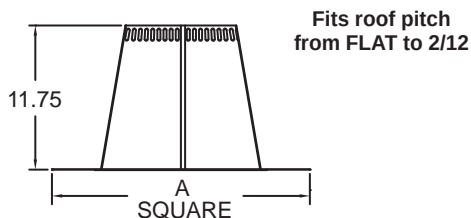

FLAT TALL CONE FLASHING – 14"-18" TGFT

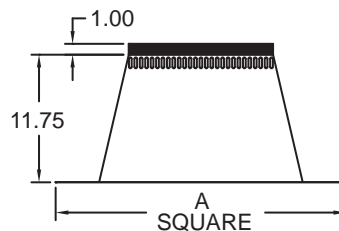

SIZE	A
6"	22.25"
7"	24.00"
8"	24.00"
10"	26.75"
12"	29.00"
14"	33.00"
16"	35.00"
18"	37.00"

NOTE: In 6" - 8" aluminum option material is recommended for oil and coal applications.

VERTICAL INSTALLATION KIT

TGCK (Galvanized only)
Available in 6", 7", & 8"
Includes:

- Cap
- Flashing
- Storm Collar
- Painted Ceiling Support

VERTICAL INSTALLATION KIT

TGCK5 (Galvanized) or TGCK5 (Stainless)
Available in 6" & 8"
Includes:

- Cap
- Flashing
- Storm Collar
- Painted Ceiling Support
- 36" Length of Pipe
- 24" Length of Pipe

THROUGH THE WALL INSTALLATION KIT

TGGTWK (Galvanized) or TGTWK (Stainless)
Available in 6" & 8"
Includes:

- Cap
- Flashing
- Storm Collar
- 2-Wall Bands
- Insulated Tee Cap
- Wall Firestop
- Wall Support/Adapter
- 6" Length of Pipe
- Single Wall Adapter



Painted Flat-Matte Black Stovepipe – Single Wall and Double Wall

- The perfect companion to Temp/Guard Chimney.
- Double Wall Warnock Hersey tested and listed to UL 103 with 6" clearance to combustibles.
- Single Wall Stovepipe and the casing of Double Wall Stovepipe are made of heavy-duty 24-gauge steel.
- Continuous laser welded flue and casing allow for clean appearance and installation.

BLACK PIPE TELESCOPING PIPE SECTIONS

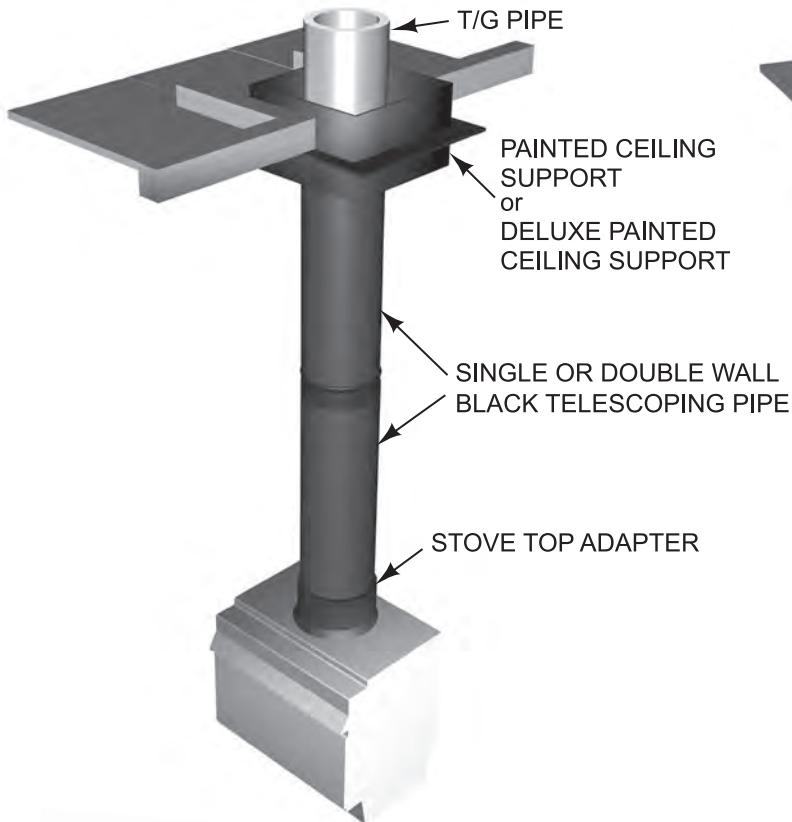

BLACK PIPE – RIGID PIPE SECTIONS

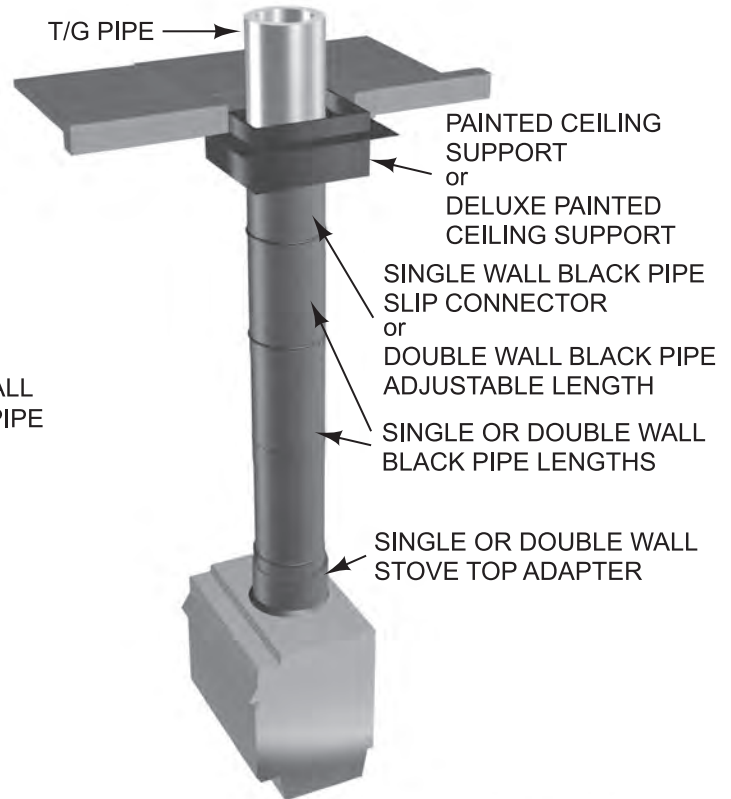

BLACK PIPE INTERIOR WITH OFFSET

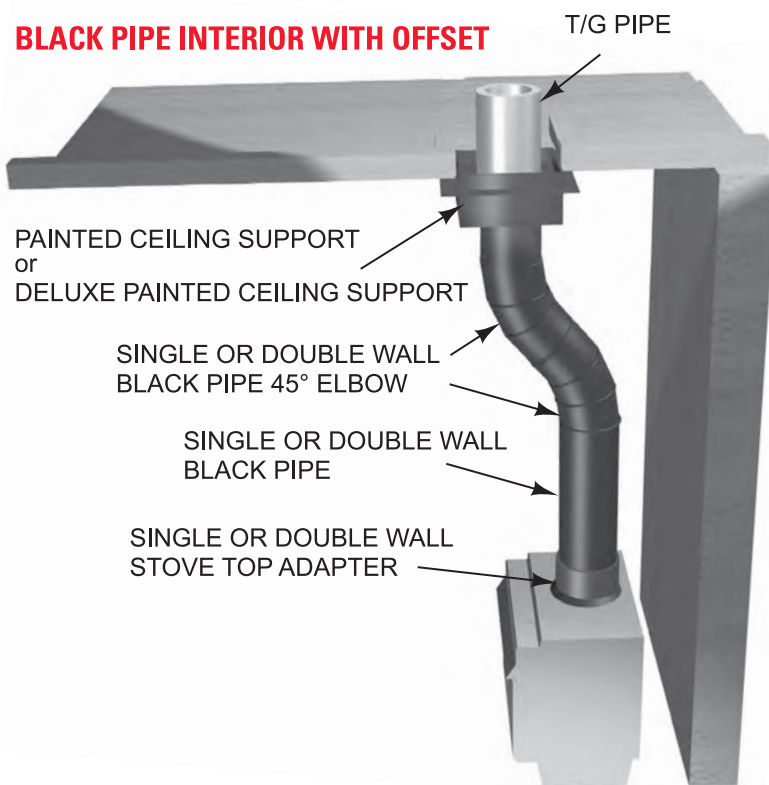

BLACK PIPE INTERIOR INTO MASONRY CHIMNEY

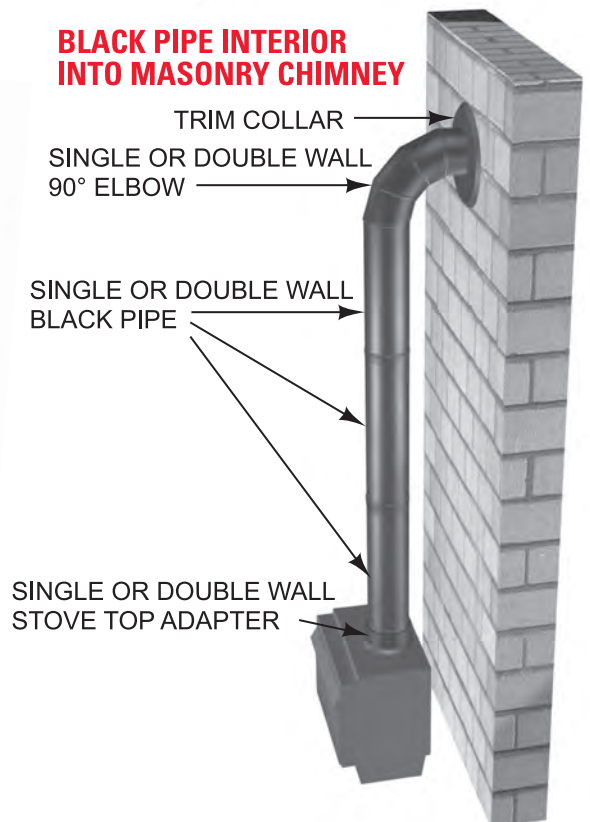

Note: Pipe overlaps 1" when joined together. Therefore, assembled length is 1" less than listed length.

PIPE SECTION – SW

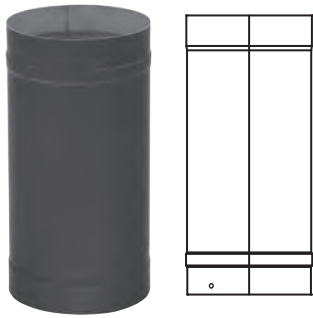

SIZE	LENGTHS		
	12"	24"	48"
6"	X	X	X
7"	X	X	
8"	X	X	X

TELESCOPING LENGTH – SWTL

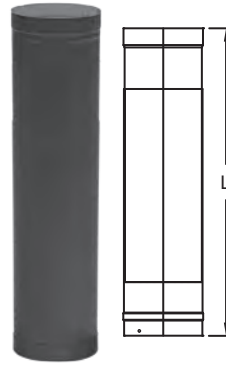

SIZE	MODEL TL48		MODEL TL66	
	MIN L	MAX L	MIN L	MAX L
6"	26.00"	48.00"	36.00"	66.00"
7"	26.00"	48.00"	36.00"	66.00"
8"	26.00"	48.00"	36.00"	66.00"

SLIP CONNECTOR – SW14S

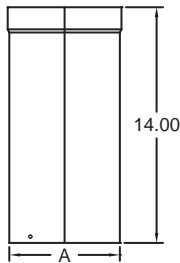

SIZE	A
6"	6.00"
7"	7.00"
8"	8.00"

45° ELBOW – SW45

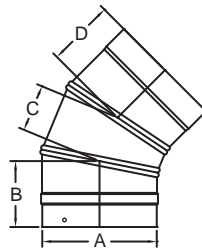

SIZE	A	B	C	D
6"	6.00"	3.50"	2.38"	3.63"
8"	8.00"	4.63"	5.00"	—

Note: Two-piece elbow for 8" diameter.

90° ELBOW – SW90

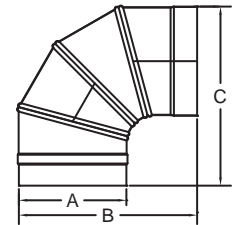

SIZE	A	B	C
6"	6.00"	10.13"	10.38"
7"	7.00"	11.88"	12.00"
8"	8.00"	12.25"	12.50"

TEE W/TEE CAP – SWT

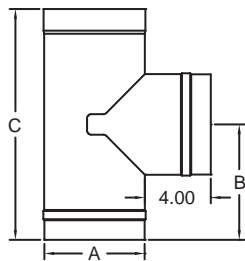

SIZE	A	B	C
6"	6.00"	7.00"	14.00"
8"	8.00"	8.00"	16.00"

STOVE TOP ADAPTER – SWA1

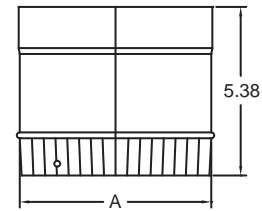

SIZE	A
6"	6.00"
7"	7.00"
8"	8.00"

TRIM COLLAR – SWTC

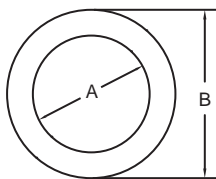

SIZE	A	B
6"	6.13"	8.88"
8"	8.13"	10.88"

INCREASER – SWI8

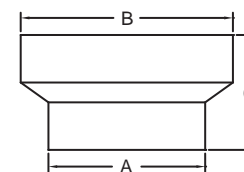

SIZE	A	B	C
6" to 8"	6.00"	8.00"	4.37"
7" to 8"	7.00"	8.00"	3.75"

Note: Pipe overlaps 1½" when joined together. Therefore, assembled length is 1½" less than listed length.

PIPE SECTION – DWB



SIZE	LENGTHS			O.D.
	12"	24"	48"	
6"	X	X	X	7.00"
8"	X	X	X	9.00"

ADJUSTABLE LENGTHS – DWB8A & 18A

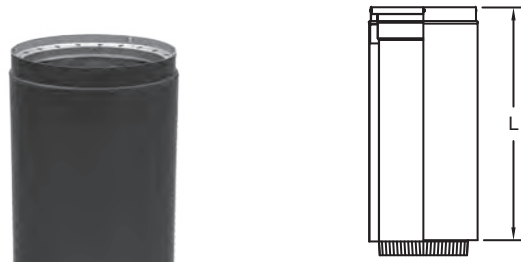

SIZE	MODEL 8A		MODEL 18A	
	MIN L	MAX L	MIN L	MAX L
6"	3.00"	6.00"	6.00"	16.00"
8"	3.00"	6.00"	6.00"	16.00"

TELESCOPING LENGTH – DWBTL

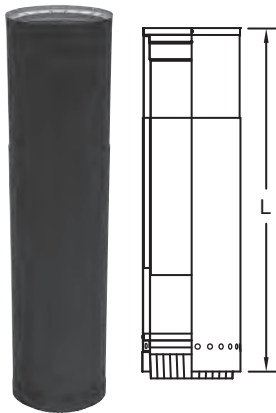

SIZE	MODEL TL48		MODEL TL66	
	MIN L	MAX L	MIN L	MAX L
6"	26.00"	48.00"	36.00"	66.00"
8"	26.00"	48.00"	36.00"	66.00"

Built-in Stove Top adapter.

TEE – W/TEE CAP – DWBT



SIZE	A	B	C	D
6"	6.00"	7.00"	13.37"	6.82"
8"	8.00"	9.00"	15.12"	7.61"

45° ELBOW – DWB45



SIZE	A	B	C	D
6"	6.00"	7.00"	5.00"	4.38"
8"	8.00"	9.00"	4.60"	4.80"

90° ELBOW – DWB90

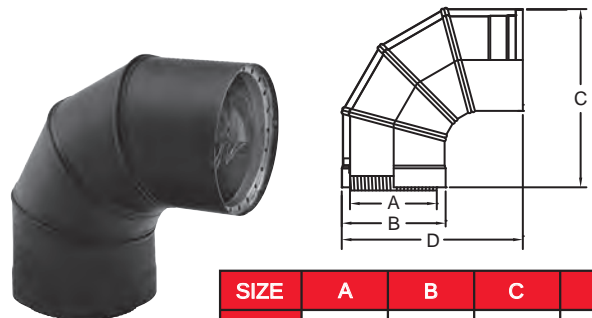

SIZE	A	B	C	D
6"	6.00"	7.00"	12.50"	12.50"
8"	8.00"	9.00"	13.50"	13.50"

STOVE TOP ADAPTER – DWBA

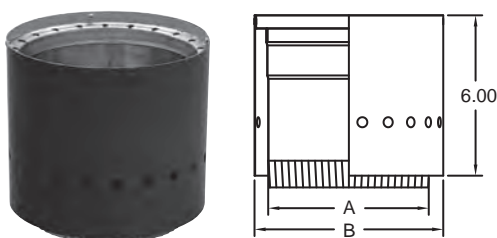

SIZE	A	B
6"	6.00"	7.00"
8"	8.00"	9.00"

Note: DWBA **must** be used when installing a Double Wall pipe system, unless starter piece is a telescoping length.

INCREASER – DWBI-8

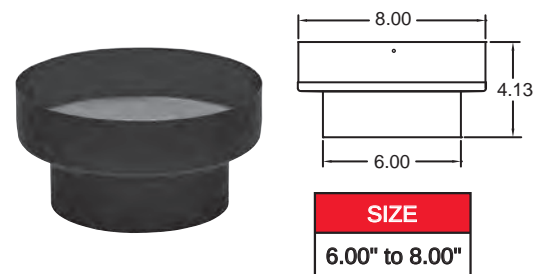

AIR-COOLED TEMP/GUARD®

INC

SOLID FUEL CHIMNEY PRODUCTS

- Listed to UL103 (1000°F continuous, 1700°F intermittent temperatures).
- Available in 8", 10", 12", 14" and 16" diameters.
- 2" clearance to combustibles.
- Double Wall Factory-Built Chimney for use with masonry fireplaces which burn wood, oil, coal or gas.
- Cost-effective alternative for pre-fabricated masonry chimneys.

Notes:

1. Air-Cooled Temp/Guard chimney, 12" & 14" utilize a Button-Lock Tab design.
2. Wall Band, Support Band and Radiation Shield are the same parts for TG & ATG.

AIR-COOLED TEMP/GUARD CHIMNEY EXTENSION

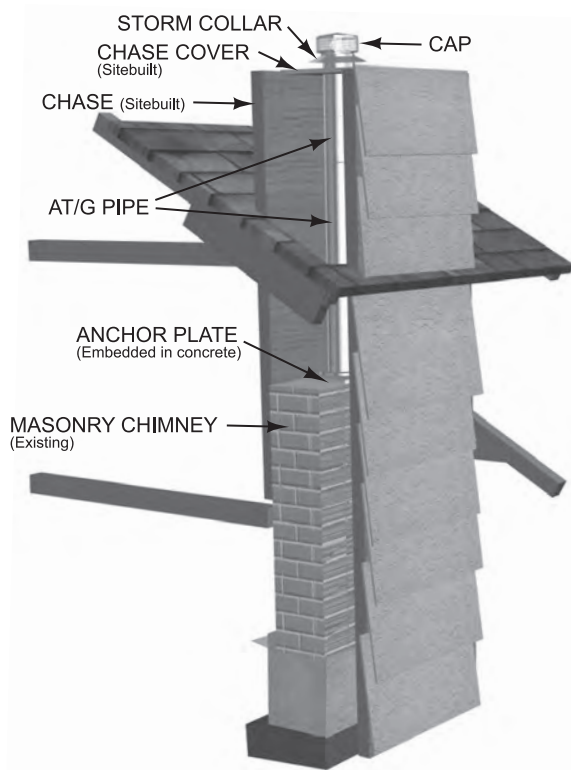

AIR-COOLED TEMP/GUARD OUTDOOR FIREPLACE

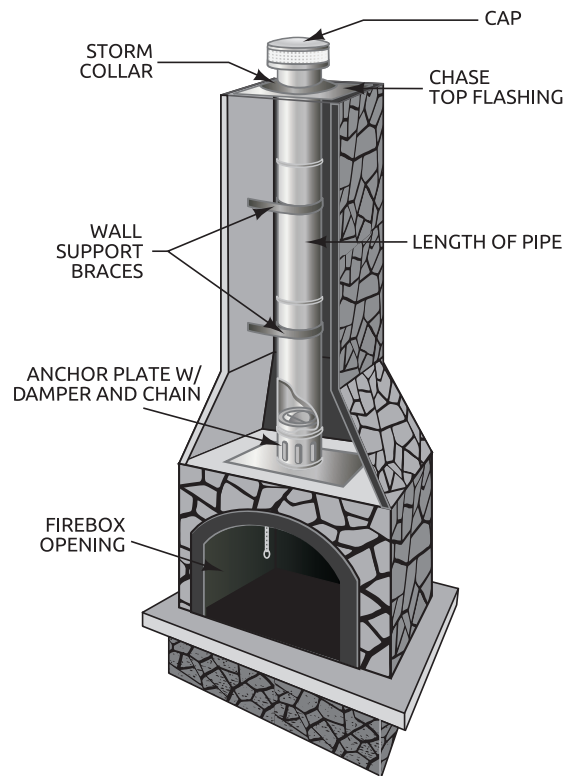

CHIMNEY PIPE – 8" -16" ATG (Aluminized Outer Casing)

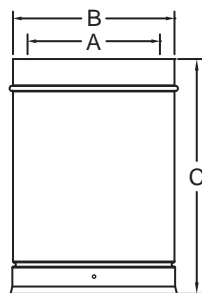

SIZE	8"	10"	12"	14"	16"
A	8.00"	10.00"	12.00"	14.00"	16.00"
B	11.00"	13.00"	15.00"	17.00"	19.00"
C	12, 18, 36, and 48 inch lengths				

NOTE: 8"-16" listed to 1700°F intermittent; 1000°F continuous.

Note: Air-Cooled Temp/Guard chimney, 12" & 14" utilize a Button-Lock Tab design.

15° ANGLE – 8" - 16" ATGA15 (Aluminized Outer Casing)

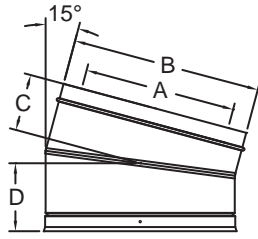

SIZE	8"	10"	12"	14"	16"
A	8.00"	10.00"	12.00"	14.00"	16.00"
B	11.00"	13.00"	15.00"	17.00"	19.00"
C	4.75"	4.88"	5.00"	5.13"	5.25"
D	5.75"	5.88"	6.00"	6.13"	6.25"

NOTE: See installation instructions for offset chart.

30° ANGLE – 8" - 16" ATGA30 (Aluminized Outer Casing)

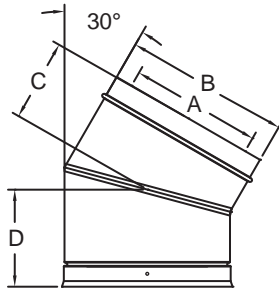

SIZE	8"	10"	12"	14"	16"
A	8.00"	10.00"	12.00"	14.00"	16.00"
B	11.00"	13.00"	15.00"	17.00"	19.00"
C	5.48"	5.75"	6.00"	6.30"	6.55"
D	6.48"	6.75"	7.00"	7.30"	7.55"

NOTE: See installation instructions for offset chart.

ANCHOR PLATE – 8" - 16" ATGAP

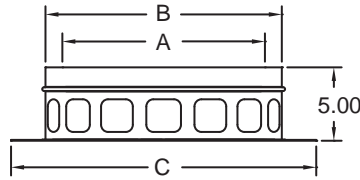
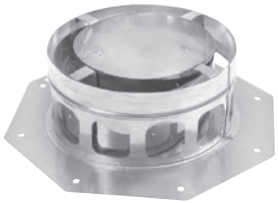

SIZE	8"	10"	12"	14"	16"
A	8.00"	10.00"	12.00"	14.00"	16.00"
B	11.00"	13.00"	15.00"	17.00"	19.00"
C	16.00"	18.00"	20.00"	21.00"	23.00"

ANCHOR PLATE W/DAMPER – 8" - 16" ATGAPD

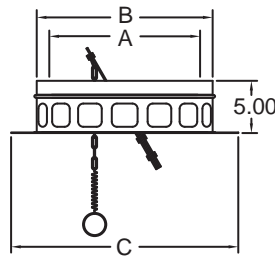

SIZE	8"	10"	12"	14"	16"
A	8.00"	10.00"	12.00"	14.00"	16.00"
B	11.00"	13.00"	15.00"	17.00"	19.00"
C	16.00"	18.00"	20.00"	21.00"	23.00"

FIRESTOP ASSEMBLY – 8" - 12" ATGFSA

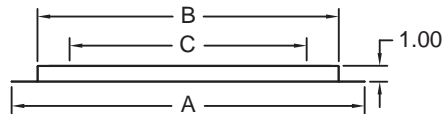
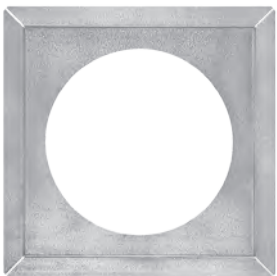

SIZE	8"	10"	12"
A	18.19"	20.19"	22.19"
B	14.94"	16.94"	18.94"
C	11.38"	13.38"	15.38"

Note: Air-Cooled Temp/Guard chimney, 12" & 14" utilize a Button-Lock Tab design.

FIRESTOP ASSEMBLY – 14"-16" ATGFSA

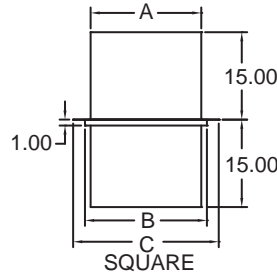

SIZE	14"	16"
A	19.00"	21.00"
B	20.94"	22.94"
C	25.00"	27.00"

INSULATION SHIELD – 8"-16" ATGIS

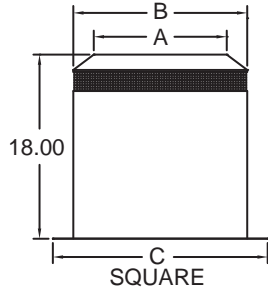

SIZE	8"	10"	12"	14"	16"
A	11.00"	13.00"	15.00"	17.00"	19.00"
B	15.00"	17.00"	19.00"	21.00"	23.00"
C	19.00"	21.00"	23.00"	25.00"	27.00"

STAINLESS CAP/SPARK ARRESTER – 8"-16" ATGC

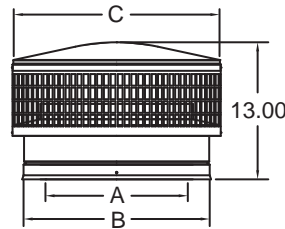

SIZE	8"	10"	12"	14"	16"
A	8.00"	10.00"	12.00"	14.00"	16.00"
B	11.00"	13.00"	15.00"	17.00"	19.00"
C	15.50"	19.13"	19.13"	19.13"	21.00"

STORM COLLAR – 8"-16" ATGSC

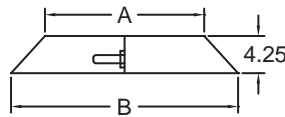

SIZE	8"	10"	12"	14"	16"
A	11.00"	13.00"	15.00"	17.00"	19.00"
B	18.75"	20.75"	22.75"	24.75"	26.75"

FLAT ROOF FLASHINGS – 8"-16" ATGFT

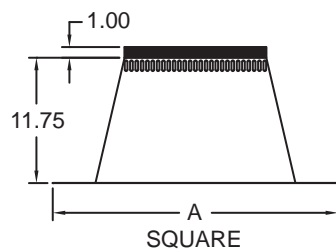
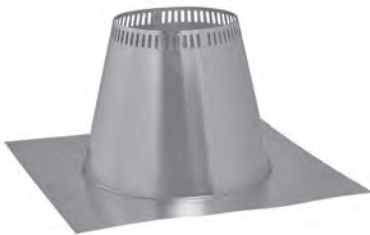

SIZE	8"	10"	12"	14"	16"
A	25.50"	27.50"	29.50"	31.50"	33.50"

Fits roof pitch from FLAT to 2/12

NOTE: For 8" diameter aluminum option material is recommended for oil and coal applications.

CHASE FLASHINGS – 8"-16" ATGFC

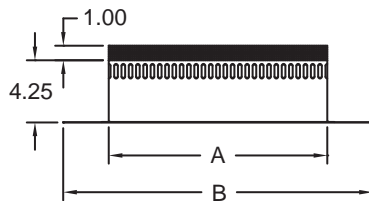
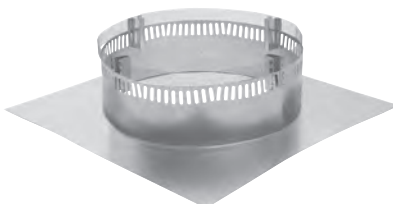

SIZE	8"	10"	12"	14"	16"
A	15.00"	17.00"	19.00"	21.00"	23.00"
B	21.25"	23.25"	25.25"	27.25"	29.25"

TYPE-B GAS VENT

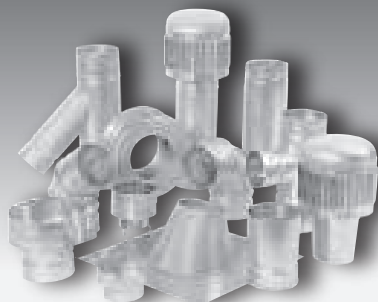

Easiest installation on the market...featuring SureLock™ B-Vent Locking System.

AIR-COOLED TEMP/GUARD®



For use with masonry fireplaces which, burn wood, oil, coal or gas.

DIRECT VENT



Premium quality, for use with gas-fired appliances.

CORR/GUARD®



Designed for corrosive appliances and exhaust systems.

FLEXIBLE CHIMNEY LINERS



Stainless steel and aluminum liner kits, connectors, and accessories.

BIOMASS



Designed for use with pellet, corn or wheat-fired appliances.

DAMPERS

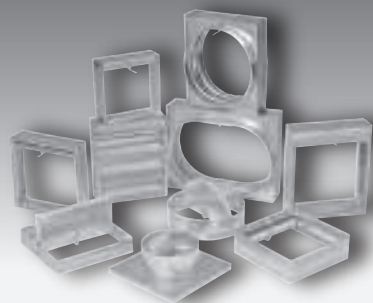

Full line of fire & ceiling radiation dampers. Capacity to fill high volume orders 100%.

PREMIUM BIOMASS

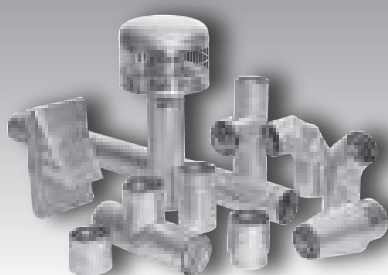

Designed for use with pellet, corn or wheat-fired appliances.

GRILLES & REGISTERS



A quality, complete line including 2x2 diffusers and extruded aluminum.

800-835-2830

