

TOTO

TOTO U.S.A., Inc. 1155 Southern Road Morrow, GA 30260
Phone : (770) 282-8686

Warranty Registration and Inquiry

For product warranty registration, TOTO U.S.A. Inc. recommends On-Line Warranty Registration. Please visit our web site <http://www.totousa.com>. If you have questions regarding warranty policy or coverage, please contact TOTO U.S.A. Inc., Customer Service Department, 1155 Southern Road, Morrow, GA 30260 (888) 295 - 8134 or (678) 466 - 1300 when calling from outside of U.S.A.

- You are advised to record the following information to allow quick service.

Date of purchase :	Name of shop :
Date : year month day	Tel : ()

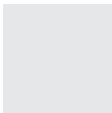

This code is for manufacturer management use.

2024.2.16
D07G50

TOTO

WASHLET

Instruction Manual

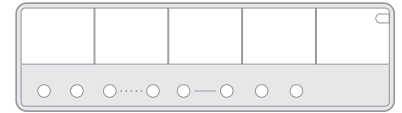

SW4736AT40, SW4736
SW4726AT40, SW4726

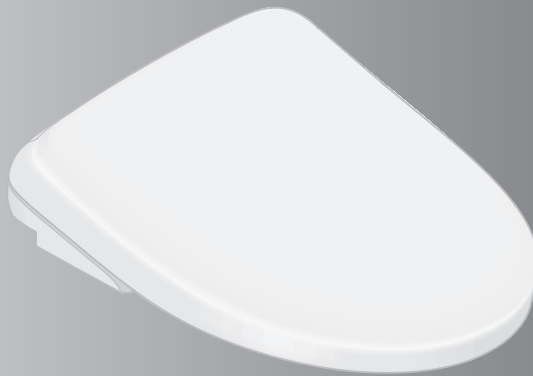

SW4734AT40, SW4734
SW4724AT40, SW4724



SW4735
SW4725



Thank you for your recent purchase of this product.

Please read the enclosed information to ensure the safe use of your product.

Be sure to read this Instruction Manual before using your product and keep it in a safe place for future reference.

Table of Contents

Introduction

Safety Precautions	4
Operational Precautions	9
Parts Names	12
Preparation	18
Using the Product for the First Time.....	18

Operation

Basic Operations	20
Mechanism of Auto Functions	20
Auto open / close	20
Auto bowl CLEAN	20
Deodorizer	20
Auto power deodorizer	20
Auto flushing	20
Auto wand CLEAN	20
Soft light	22
CLEAN indicator	22
Using the Remote Control	23
Stop	23
Rear washing	23
Rear soft washing	23
Front washing	23
Wide front washing	23
Warm air drying	23
Water pressure adjustment	23
Wand position adjustment	23
Pulsating washing	23
Oscillating washing	23
Wand CLEAN	24
Power dedorizer	24
Full flush	24
Light flush	24
Opening and closing the toilet lid	24
Opening and closing the toilet seat	24
Personal setting	24
Low battery warning mark	24
Power ON/OFF button	25
Wand cleaning	25
Manual spray	25
Warm water temperature	25
Toilet seat temperature	25
Drying air temperature	25
Auto energy saver / Auto energy saver+	25
Timer energy saver	25

Auto open / close ON / OFF	25
Setting confirmation	25
Auto flushing ON /OFF	25
Temperature Adjustment	26
Warm water / Toilet seat / Drying	26
Changing Settings	28
Setting List	28
The energy saver features	30
How to Set	32
Auto energy saver	32
Auto energy saver+	32
Timer energy saver	33
Auto flushing	33
Auto flush delay	34
Auto flush lid closed	34
Auto flush lid relation	36
Auto open / close	37
Auto close delay	37
Auto open delay	38
Seat/lid	38
Auto wand CLEAN	39
Auto bowl CLEAN	39
Deodorizer	40
Auto power deodorizer	40
Night light	41
Soft light	42
Bowl light	42
CLEAN indicator	43
Beep sound	43
Pressure/Position setting	44
Personal setting	44
Registering Personal Settings	45
Sensor detection range	46

Maintenance

Maintenance	47
Before maintenance	47
Power Plug	47
Main Unit	48
Manual spray	48
Gap between the Main Unit and Bowl Unit.....	49
Gap between the Main Unit and the Toilet Lid .	50
Wand	51
Wand cleaning	51
Deodorizing Filter	52
Drain plug with water supply filter	53

Reference

What to Do?	54
If the water does not flow due to a water service interruption	54
If you cannot operate with the remote control	54
Replacing the batteries	54
Freeze Damage Prevention	55
Long Periods of Disuse.....	56
How to drain the water	56
Resupplying the Water.....	57
How to remove the operation guide	58
Troubleshooting	59
Please check first	59
Rear Washing, Front Washing and Wand	60
Warm air drying	61
Flushing	61
Toilet Seat and Toilet Lid (Auto open/close) ...	62
Toilet Seat and Toilet Lid.....	63
Auto flush lid closed.....	64
Auto flush lid relation	64
Energy Saver.....	64
Deodorizer.....	65
Auto bowl CLEAN, Manual Spray	65
Lights	66
Others	66
Specifications	68
Limited Warranty	68

The available functions vary according to the part no.

Functions	Model No.**1			
	SW4736AT40 SW4736 SW4734AT40 SW4734	SW4726AT40 SW4726 SW4724AT40 SW4724	SW4735	SW4725
Remote control flushing	●*2	●*2*3	-	-
Auto flushing				
Opening and closing the toilet seat and lid with remote control	●	-	●	-
Auto open / close				

The illustrations in the instruction manual may differ from the actual product.

*1 The model no. is on the toilet lid label. (→Pages 12, 14)

*2 Available only when "Flush" button is located on the top side of the remote control. (→Page 24)

*3 Auto flushing will not be activated when the user uses the toilet in standing position.

Safety Precautions

IMPORTANT SAFEGUARDS

READ ALL INSTRUCTIONS BEFORE USING

Symbols and Meanings



WARNING

May result in death or serious injury.



CAUTION

May result in injury or property damage.



WARNING

Never disassemble, repair or alter.

Doing so may cause fire, electrical shock, overheating, short circuit or breakdown.

Do not use the product if a malfunction occurs.

In case of breakdown or other problem, be sure to cut off power by means such as unplugging the power plug.

Close the water shutoff valve to stop water supply.

Possible malfunctions:

- Water is leaking from a pipe or the main unit.
- The product is cracked or broken.
- The product makes a strange noise or emits a strange odor.
- The product emits smoke.
- The product is abnormally hot.
- The toilet seat cushion is out of place.

Continued use after malfunction could cause a fire, electrical shock, heat, short circuit, injury or water damage.

Do not use other water than allowed by the laws and ordinances of the region of use. Only Use potable water.

Do not use seawater or recycled water.

Doing so may cause irritation to the skin and malfunction.

Keep cigarettes and other open flames away from the product.

Failure to do so may cause fire.

Refrain from sitting on the seat for long periods.

It may cause low-temperature burns.

To prevent the following persons from getting a moderate temperature burn during use, other person should turn off the toilet seat heater and set the dryer temperature to "Low".

- Young children, the aged and other users unable to set the temperature appropriately themselves.
- The ill, physically disabled and others who do not have freedom of movement.
- Those using any medicines that cause drowsiness (sleeping or cold medicine), those who have been drinking heavily, anyone severely fatigued and anyone else liable to fall asleep.

If the power cord is damaged, avoid danger by having the manufacturer's repair department or equivalent specialist replace it.

Turn the power OFF before maintenance or inspection.*1

Failure to do so may cause electrical shock or malfunction.

Always the power OFF before removing the main unit.*1

Failure to do so may cause a fire or electrical shock.

When leaking battery fluid adheres to your body or clothes, wash it away with clean water.

The fluid may damage your eyes or skin.

*1 How to turn off the product (→Page 19)

WARNING

Do not stick a finger or anything else into the warm air outlet.

Do not place anything on the warm air outlet or drape clothes over it.

Doing so may cause burns, electrical shock or malfunction.

Do not install the product on moving vehicles such as wheeled vehicles or boats.

Doing so may cause fire, electric shock, short circuit or malfunction.

The toilet seat, toilet lid, main unit, or other parts may come loose and fall off, resulting in injury.

Do not use any power supply other than the one specified.

AC 120 V, 60 Hz

Doing so may cause fire or excessive heat.

This is an electrical product. Do not install it anywhere water is likely to get on the product or anywhere with humidity high enough that water is likely to form on the surface of this product. When using the product in a bathroom, install a fan or ventilation port and ensure good air flow through the bathroom.

Failure to do so may cause fire or electrical shock.

Always connect the product to the cold water supply.

Connecting to hot water supply may result in burns and equipment damage.

Preliminary studies in females suggest that over-use of continuous spraying can increase the possibility of vaginal mucosa drying and potential reduction in desirable microbial organisms.

Although these studies have not been validated, please consult your healthcare provider for concerns regarding whether these circumstances may apply to you.

More importantly, if you are an individual suffering from any immune deficiency as a result of disease, chemotherapy, or other medical condition compromising the immune system you should consult your healthcare provider before use of this product.

Do not touch the connection of power cord with wet hands.

Doing so may cause electrical shock.

Do not get any water or cleaning solution on the main unit, in the gap between the main unit and bowl unit, or on the power supply connections.

Doing so may cause fire, electrical shock, heat or short circuit.

Doing so may cause the product to crack resulting in injury or water damage.

Do not touch the power source connection during thunderstorms.

Doing so may cause electrical shock.

Do not allow the water supply hose to touch the power source connection.

Doing so may cause condensation resulting in a fire, electrical shock, heat or a short.

Do not do anything that may damage the power cord or power source connection.

Do not strike, yank, twist, excessively bend, damage, alter, or heat the power cords.

Also, do not place anything heavy on, bind or pinch the power cords.

Using a damaged power cord may result in a fire, electrical shock, heat or short.

Confirm that a properly grounded outlet has been installed.

Failure to install a grounded outlet could cause electrical shock in the event of a malfunction.

*If there is no ground installed, ask the contractor who did the installation to install the ground.

Periodically remove dust and dirt from the power plug and make sure it is securely plugged into the wall outlet.

Failure to do so may cause fire, heat or short circuit. Pull the power plug out from the outlet and wipe clean with a dry cloth.

Safety Precautions

WARNING

Do not use a loose or faulty electrical outlet.

Doing so may cause fire or short circuit.

Do not use any outlet beyond its specified rating.

Plugging too many plugs into the same outlet, for example using outlet splitters, can cause fire due to heat.

Insert the power plug securely into the outlet.

Failure to do so may cause fire, heat or short circuit.

To unplug, hold the power plug, not the power cord.

Do not unplug by pulling the power cord.

Pulling on the power cord may cause damage and result in fire or heat.

CAUTION

Do not use the product if the main unit is unstable.

Doing so may cause the main unit to come loose and fall, resulting in injury.

If the product is damaged, do not touch the damaged section.

Doing so may cause electrical shock or injury.
Replace it immediately.

Do not apply strong force, mechanical shock, step on or stand on the toilet seat, toilet lid or main unit.

Also do not place any heavy object on the toilet seat, toilet lid or main unit.

Doing so may cause cracking or cause the main unit to come loose and fall, resulting in injury.

Doing so may damage the product and cause injury or water damage.

Do not lift up this product by the toilet seat or lid.

Do not raise the toilet seat or lid while objects are resting on top of the unit.

Doing so may cause the main unit to come loose and fall, resulting in injury.

When maintaining the plastic parts (main unit etc.) or the water supply hose, use a pH neutral kitchen detergent diluted with water. Do not use any of the following.

Toilet cleaner, household cleaner, benzene, paint thinner, powdered cleanser or nylon scrubbing brush.

These items may damage or crack the plastic and cause injury or malfunction.

These items could damage the water supply hose and cause a water leak.

CAUTION

To prevent a sudden water leak, do not remove the drain plug with water supply filter when the shutoff valve is open.

Doing so will cause water to spurt out.
(→Refer to Page 53 for instructions on cleaning the drain plug with water supply filter.)

Do not fold or crush the water supply hose; do not damage by cutting with a sharp object.

Doing so may cause water leaks.

Do not install the base plate, which is not attached.

Doing so may cause damage.

If a water leak should occur, always close the shutoff valve.

When the ambient temperature is likely to drop to 32 °F (0 °C) or lower, prevent damage to the pipes and hoses due to freezing.

Frozen water pipes could cause the main unit and the pipes to break, resulting in a water leak.
Regulate the room temperature to prevent the pipes and hoses from freezing during cold months.
Drain the water.

When not using the product for a long time, close the shutoff valve, drain the water from the main unit and water supply hose, and then turn the power OFF.*1

When using the product again, allow the product to refill with water first. Otherwise, the water in the tank might become contaminated and cause skin inflammation or other problems. (→Refer to Page 57 for instructions on replenishing the water.)
Leaving the power on may cause fire or heat.

When installing the drain plug with water supply filter, make sure that it is securely tightened in its proper position.

Failure to securely tighten it may cause a water leak.

If the bowl is clogged, turn the power OFF*1 and remove the clog.*2

If the auto flush were allowed to function, it would make the wastewater in the bowl unit overflow and may result in water damage.
Use commercially available tools that are made for unclogging the bowl unit to remove the clogging.

Push the main unit securely on to the base plate.

After pushing the main unit until a click sound is heard, pull it slightly toward you to make sure that the product does not detach.
Doing so may cause the main unit to come loose and fall, resulting in injury.

Make sure of the plus and minus signs on the batteries before inserting them.

Remove depleted batteries immediately.

When replacing the batteries:

- Replace both batteries with new ones.
- Use the same brand for both new batteries (any brand available).

Failure to do so may cause the batteries to leak fluid, generate heat, rupture, or ignite.

When the product is supposed not to be used for long time, remove the batteries from the remote control.

Failure to do so may cause the batteries to leak fluid.

*1 How to turn off the product (→Page 19)

*2 Available only when "Flush" button is located on the top side of the remote control. (→Page 24)

Safety Precautions

DANGER

To reduce the risk of electrocution:

1. Do not use while bathing.
2. Do not place or store the product where it can fall or be pulled into a tub or sink.
3. Do not place in or drop into water or other liquid.
4. Do not reach for the product when it has fallen into water. Unplug it immediately.

WARNING

To reduce the risk of burns, electrocution, fire or injury to persons:

1. Close supervision is necessary when this product is used by, on, or near children or invalids.
2. Use this product only for its intended use as described in this manual. Do not use attachments not recommended by the manufacturer.
3. Never operate this product if it has a damaged cord or plug, is not working properly, has been dropped or damaged, or has been dropped in water. Return the product to a service center for examination and repair.
4. Keep the cord away from heated surfaces.
5. Never block the air openings on the product or place it on a soft surface, such as a bed or couch, where the air openings may be blocked. Keep the air openings free of lint, hair, and other similar items.
6. Never use while sleepy or drowsy.
7. Never drop or insert any object into any opening or hose.
8. Do not use outdoors. Do not operate where aerosol (spray) products are being used or where oxygen is being administered.
9. Connect this product to a properly grounded outlet only.
See "Grounding Instructions" in below.
10. The tank should be filled with water only.

- Servicing should be performed by an authorized service representative.
- This product is for household use.

Grounding Instructions

This product should be grounded. In the event of an electrical short circuit, grounding reduces the risk of electric shock by providing an escape wire for the electrical current.

This product is equipped with a cord having a grounding wire with a grounding plug.

The plug must be plugged into an outlet that is properly installed and grounded.

 **DANGER** - Improper use of the grounding plug can result in a risk of electric shock.

If repair or replacement of the cord or plug is necessary, do not connect the grounding wire to either flat-head terminal.

Check with a qualified electrician or serviceman if the grounding wire instructions are not completely understood, or if in doubt as to whether the product is properly grounded.

SAVE THESE INSTRUCTIONS

Operational Precautions

SW4736AT40, SW4736, SW4734AT40, SW4734, SW4735

About the built-in body sensor

The body sensor detects human movement.

The toilet lid opening or "Auto bowl CLEAN" operation may be triggered by someone outside the bathroom as the sensor detects human movement through the door or wall in front of the main unit.

The sensor may not detect properly depending on the bathroom layout, resulting in the toilet lid not opening automatically.

For someone small such as a child, the body sensor may not detect properly, resulting in the toilet lid not opening automatically.

When you are using the toilet in standing position, the length of time it takes for "Auto flushing" to complete or for the toilet lid or seat to close automatically depends on the bathroom layout, etc.

SW4726AT40, SW4726, SW4724AT40, SW4724, SW4725

For prevention of malfunctions

Do not block the body sensor.

About the body sensors

Body sensor detects changes in heat.

Detection may be difficult when the room temperature exceeds 30 °C, such as in the summertime.

When sunlight is directly on the sensor area or a heater is used in the bathroom, the sensor may detect incorrectly due to the heat, resulting in the automatic operation of "Auto bowl CLEAN".

When the bathroom door is open, the sensor may detect people who pass to the front or side of the toilet.

Detection by the sensor may be difficult when the toilet is used by someone small, such as a child.

Body sensor
(Detects changes in heat)



About the built-in seat sensor

When you sit on the toilet seat, the seat sensor turns ON, enabling you to use various features. (The deodorizer starts when the seat sensor makes a detection.)

A label indicating the position of the seat sensor is attached to the seat.

Detection by the sensor may be difficult when the toilet is used by someone small, such as a child, depending on how the person sits.

Sit on the seat with the label as a guide. (The label can be peeled off).

Sit down so that the seat sensor touches your skin directly. The seat sensor may not detect properly if there is a seat cover or clothing. If you use the booster seat for infants, the seat sensor may not detect properly, resulting in the toilet lid closing automatically during use. Turn "Auto open / close" OFF before use.*1

Water droplets collecting on the seat sensor may cause the main unit to malfunction. Be sure to wipe off any water droplets on the sensor.

Detection range

SW4736AT40, SW4736, SW4726AT40, SW4726
SW4734AT40, SW4734, SW4724AT40, SW4724

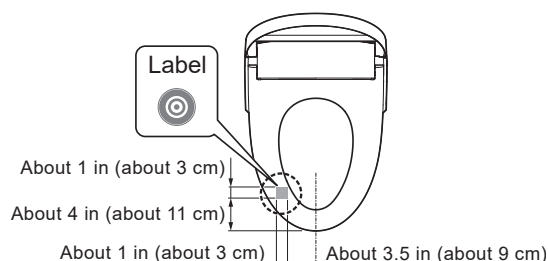

SW4735, SW4725

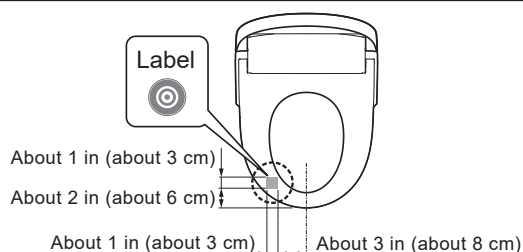

*1 Except SW4726AT40, SW4726, SW4724AT40, SW4724, SW4725.

Operational Precautions

For prevention of damage

Wipe plastic areas such as the main unit and remote control with a soft cloth tightly wrung out with water.

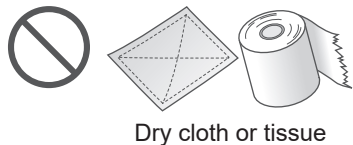

Dry cloth or tissue

Do not lean against the toilet lid.



For prevention of malfunctions and failures

Do not block the remote control transmitter or receiver.
May cause main unit to malfunction.

Turn the power OFF if there is a risk for lightning strike.*1

A toilet seat cover or a toilet lid cover cannot be used.
Otherwise, the body sensor*2 and seat sensor may not detect properly.
Additionally, the toilet seat and lid may not open or close properly.

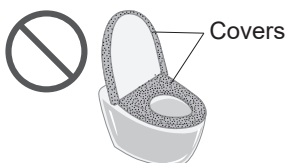

Do not urinate on the main unit, toilet seat or wand.
Doing so may cause a failure or discoloration.

Do not apply strong forces to the control panel of the remote control.

When using a toilet cleaner to clean the toilet, rinse it off within 3 minutes and leave the toilet seat and toilet lid open.

If vapor from a toilet cleaner enters the main unit, it may cause a malfunction.

► Wipe off any cleaner that remains on the bowl unit.

Note: If "Auto flush lid closed" *3 (→ Pages 34, 35) is turned ON and you use the remote control to flush the bowl unit, the toilet seat and lid close before flushing the bowl unit.

After the bowl unit has been flushed, open the toilet seat and lid.

Do not use the product with the toilet lid removed.

Do not expose to direct sunlight.

Doing so may cause changes in color, irregular heated seat temperature or remote control malfunction.
It may also cause product malfunction due to the change in temperature.

Use radios, etc. away from the product.

The product could cause interference with the radio signal.

If you use a booster seat for infants or a soft high-chair, remove it after use.

Keeping it installed may prevent some of the functions from being used.

Do not apply force to the remote control.

This cause malfunction.

► To prevent the remote control from being dropped, set it in the hanger when you are not using it.
Be careful not to expose it to water.

Do not place anything on the toilet seat, and do not press them with hands.

Doing so may activate the seat sensor, causing the floor to get wet if buttons on the remote control are touched and warm water comes out from the wand.

*1 How to turn off the product (→Page 19)

*2 Except SW4736AT40, SW4736, SW4734AT40, SW4734, SW4735

*3 Except SW4726AT40, SW4726, SW4724AT40, SW4724, SW4725

■ Body Sensor Compliance

● FEDERAL COMMUNICATIONS COMMISSION (FCC) INTERFERENCE STATEMENT

This equipment has been tested and found to comply with the limits for a Class B digital device, pursuant to part 15 of the FCC Rules. These limits are designed to provide reasonable protection against harmful interference in a residential installation. This equipment generates, uses and can radiate radio frequency energy and, if not installed and used in accordance with the instructions, may cause harmful interference to radio communications.

However, there is no guarantee that interference will not occur in a particular installation.

If this equipment does cause harmful interference to radio or television reception, which can be determined by turning the equipment off and on, the user is encouraged to try to correct the interference by one or more of the following measures:

- Reorient or relocate the receiving antenna.
- Increase the separation between the equipment and receiver.
- Connect the equipment into an outlet on a circuit different from that to which the receiver is connected.
- Consult the dealer or an experienced radio/TV technician for help.

CAUTION:

Any changes or modifications not expressly approved by the grantee of this device could void the user's authority to operate the equipment.

This device complies with part 15 of the FCC Rules.

Operation is subject to the following two conditions:

- (1) this device may not cause harmful interference, and
- (2) this device must accept any interference received, including interference that may cause undesired operation.

RF exposure warning

This equipment complies with FCC RF exposure limits set forth for an uncontrolled environment.

This equipment must not be co-located or operating in conjunction with any other antenna or transmitter.

● Canada, Industry Canada (IC) Notices

This device complies with Industry Canada's licence-exempt RSSs.

Operation is subject to the following two conditions:

- (1) This device may not cause interference; and
- (2) This device must accept any interference, including interference that may cause undesired operation of the device.

Radio Frequency (RF) Exposure Information

The radiated output power of the Wireless Device is below the Industry Canada (IC) radio frequency exposure limits.

The Wireless Device should be used in such a manner such that the potential for human contact during normal operation is minimized.

This device has also been evaluated and shown compliant with the IC RF Exposure limits under portable exposure conditions.

(antennas are less than 8 inch (20 cm) of a person's body).

Parts Names

SW4736AT40, SW4736
SW4726AT40, SW4726

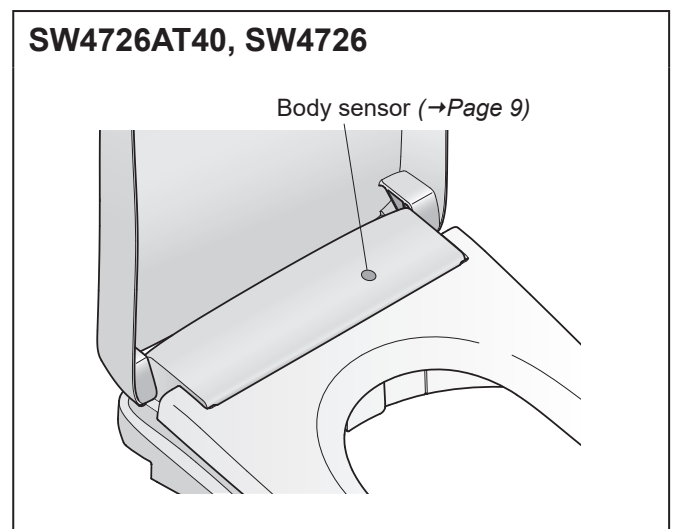
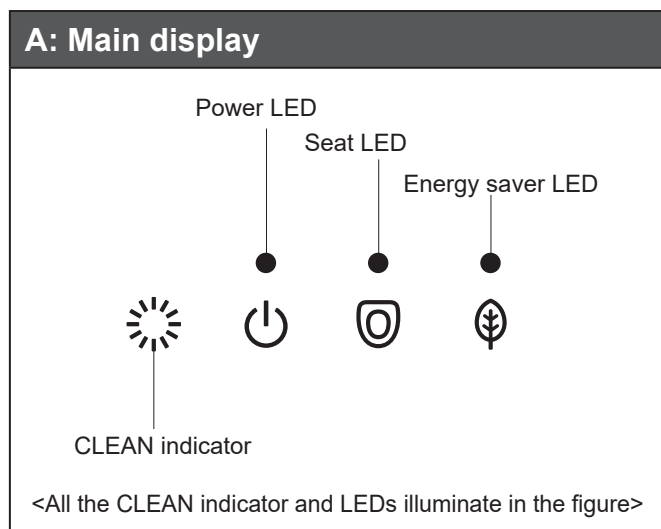
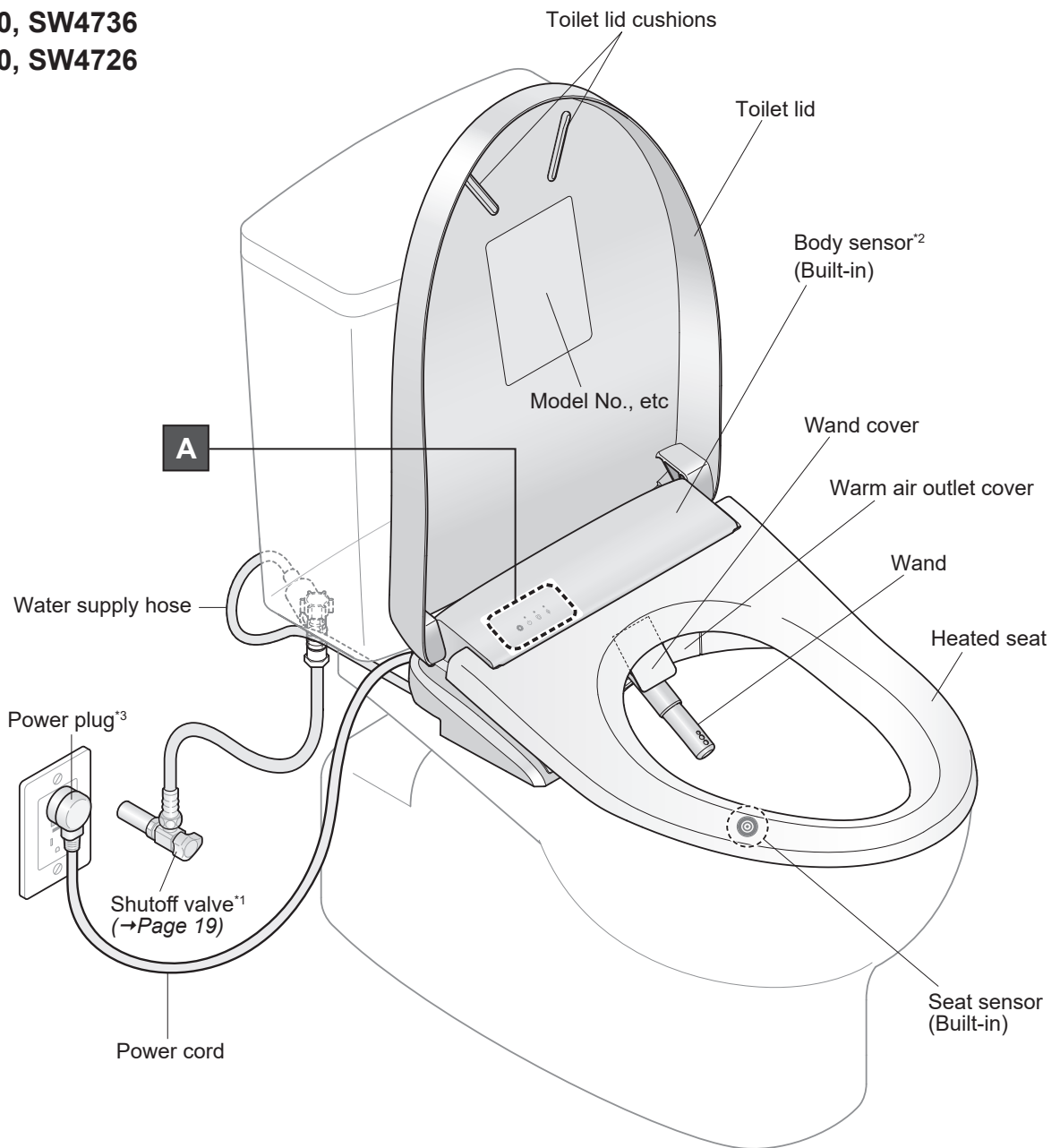

*1 The shape and location vary depending on the type of bowl unit and tank.

*2 Except SW4726AT40, SW4726

*3 The shape of the power plug may vary.

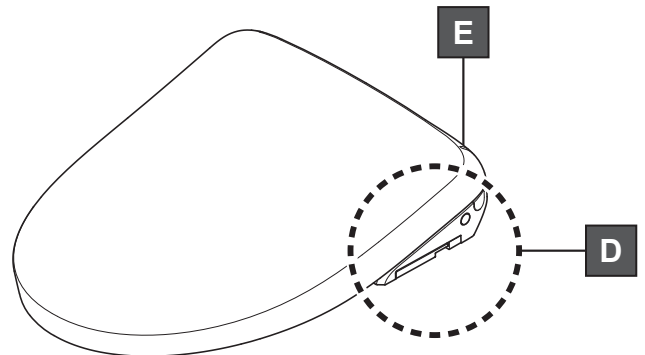
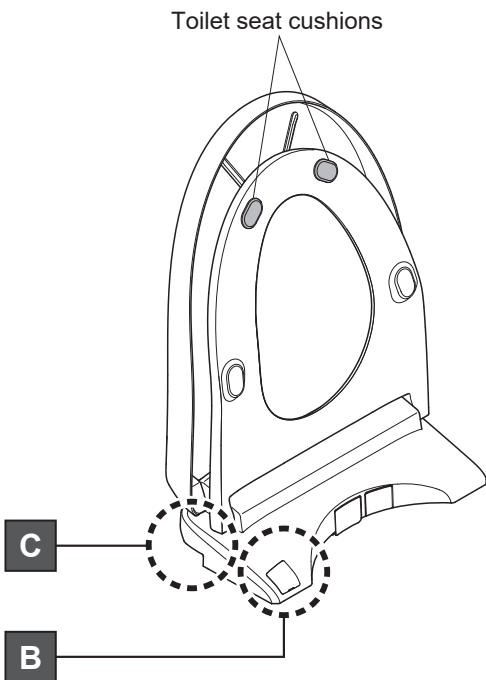

B: Front side of the main unit

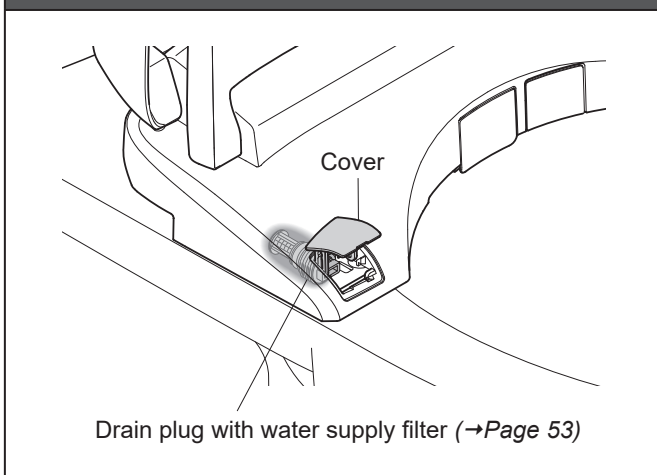

D: Right side of the main unit

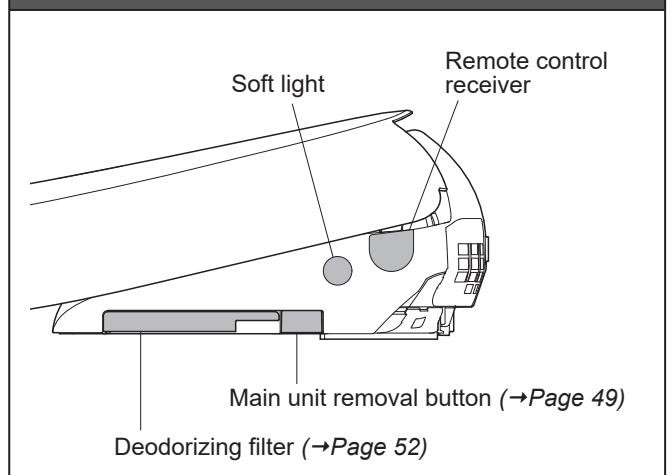

C: Left side of the main unit

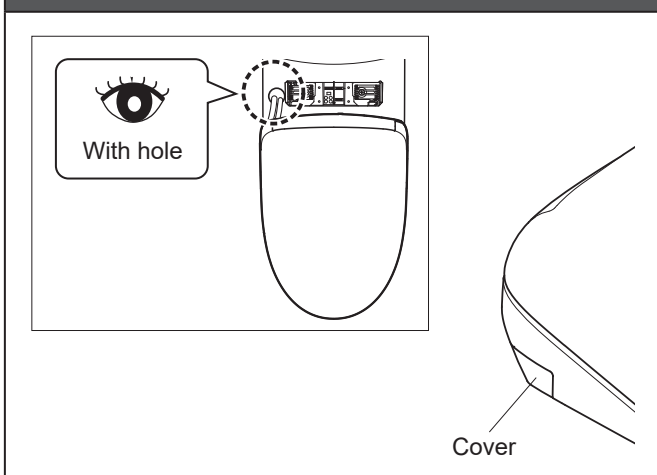

E: Rear side of the main unit

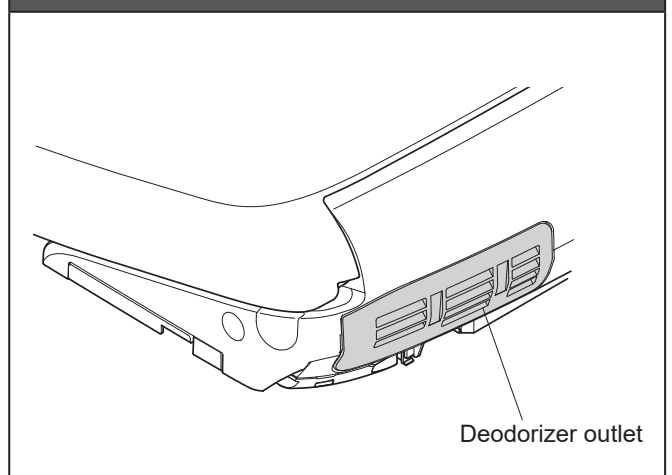

Parts Names

SW4734AT40, SW4734
SW4724AT40, SW4724

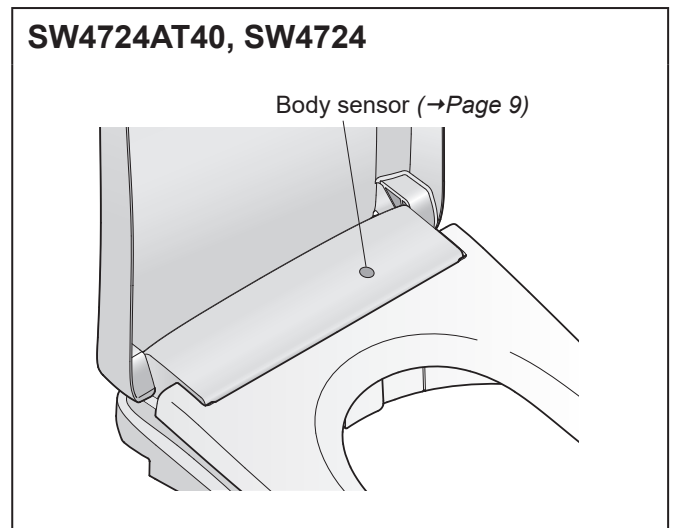
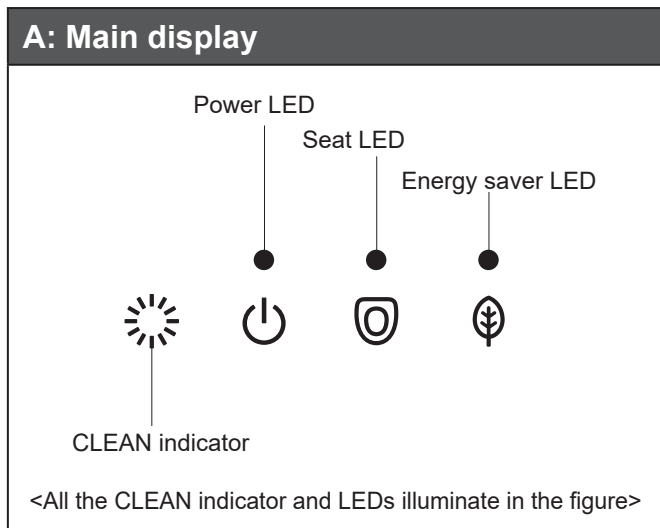
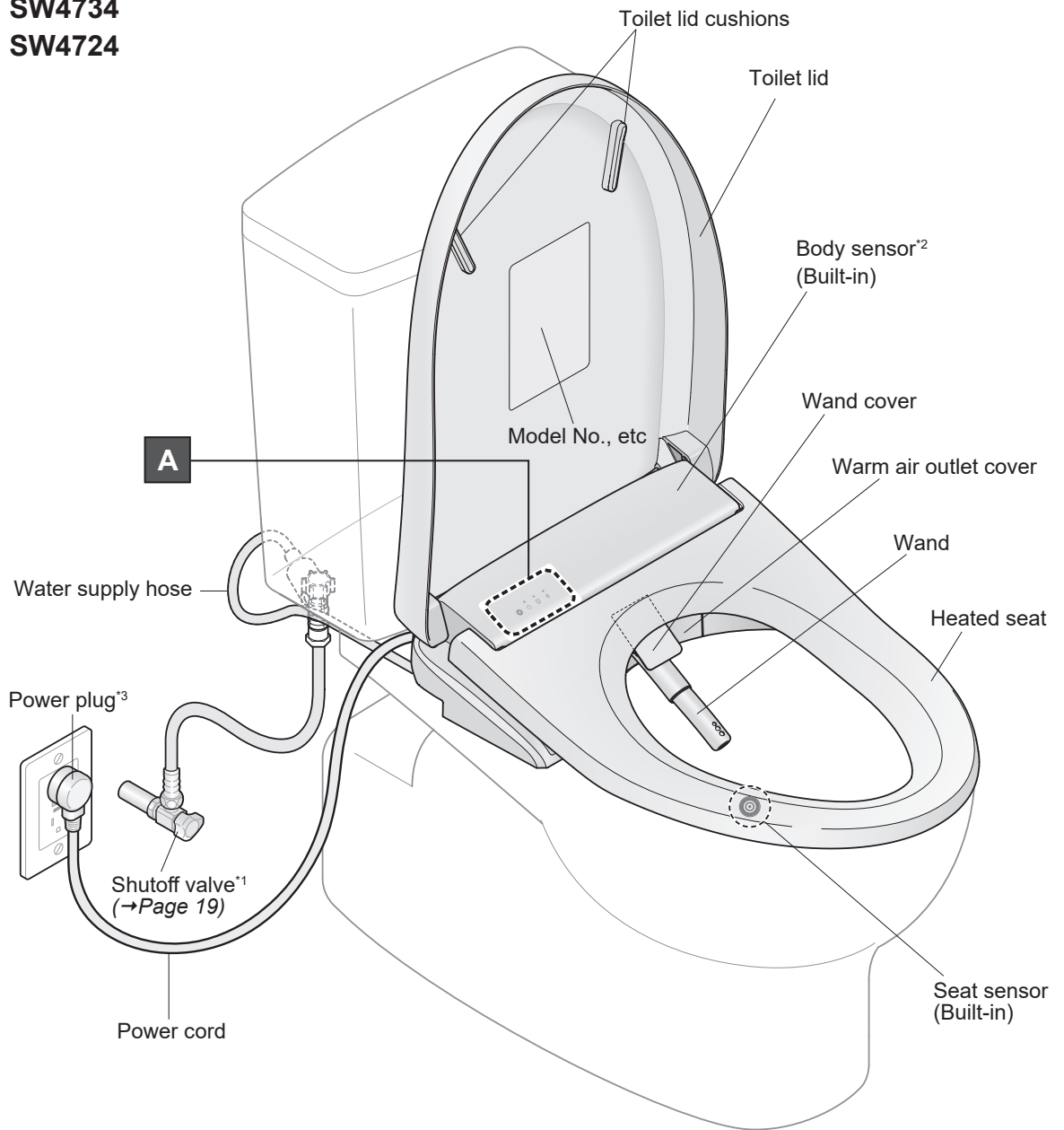

*1 The shape and location vary depending on the type of bowl unit and tank.

*2 Except SW4724AT40, SW4724

*3 The shape of the power plug may vary.

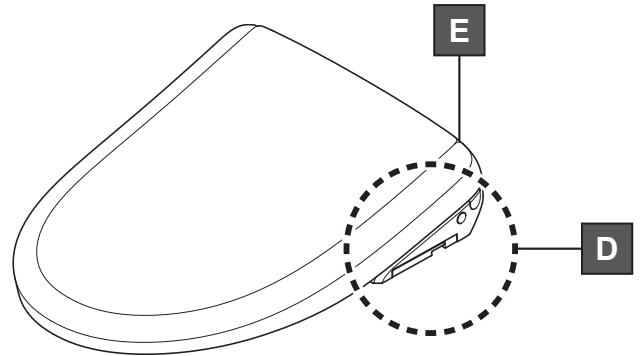
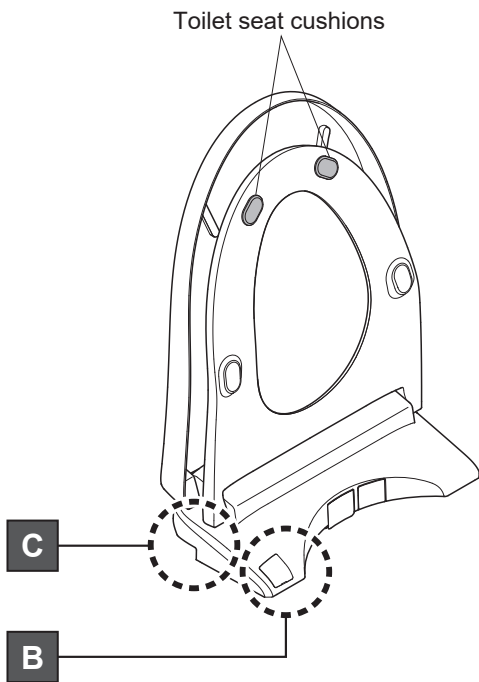

B: Front side of the main unit

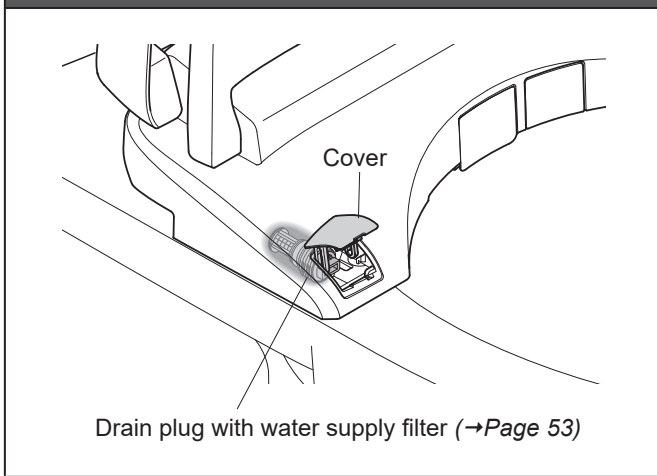

D: Right side of the main unit

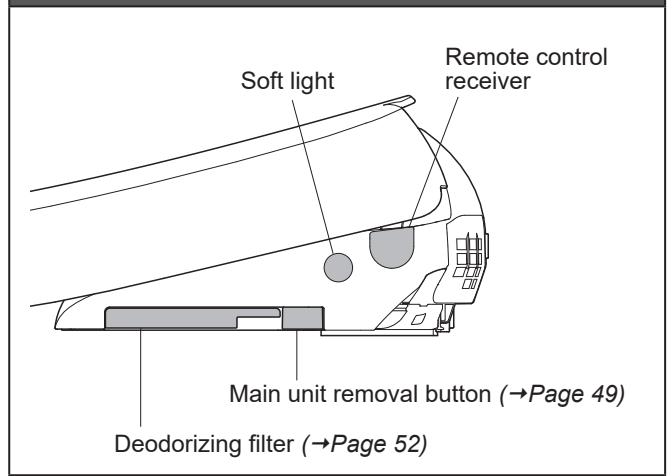

C: Left side of the main unit

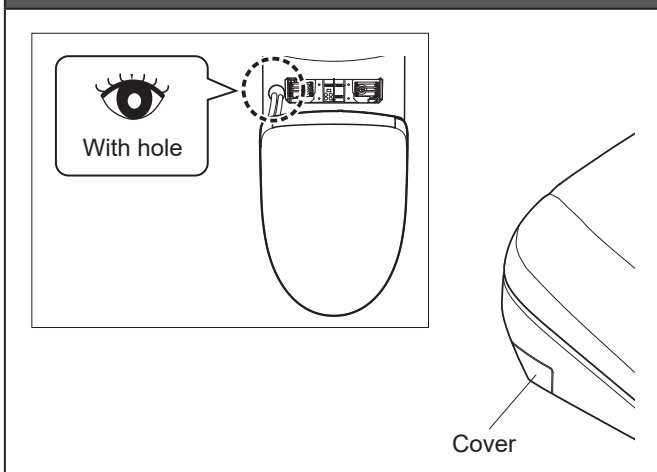

E: Rear side of the main unit

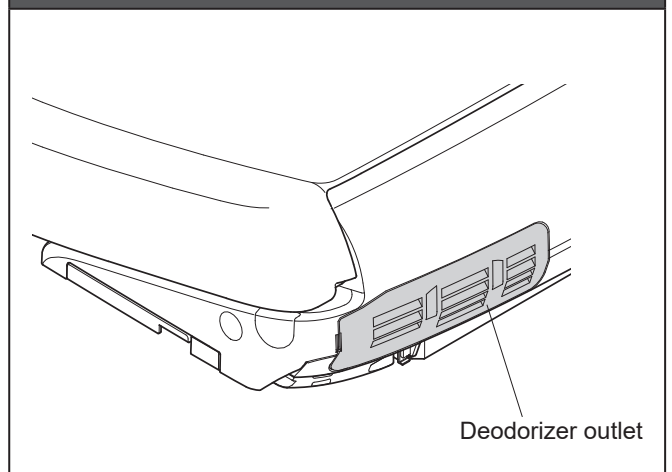

Parts Names

SW4735
SW4725

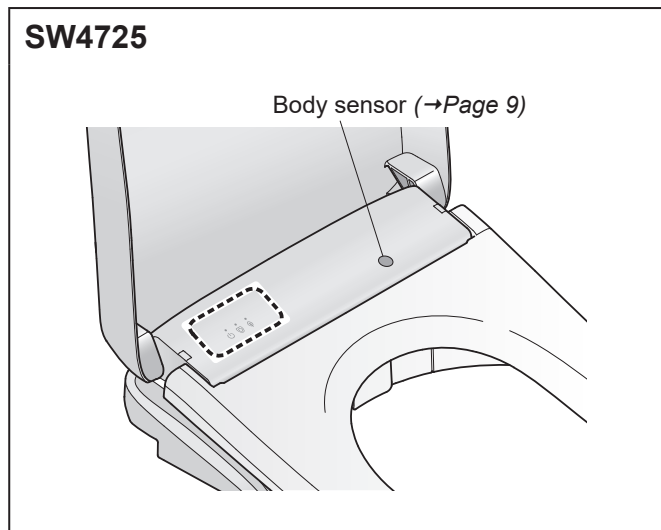
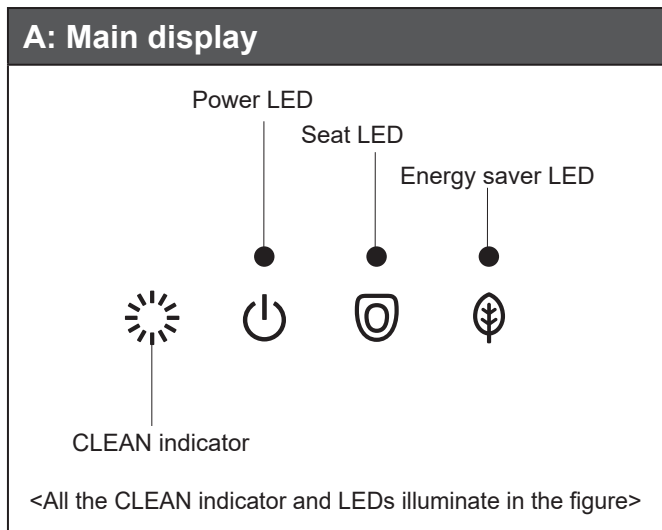
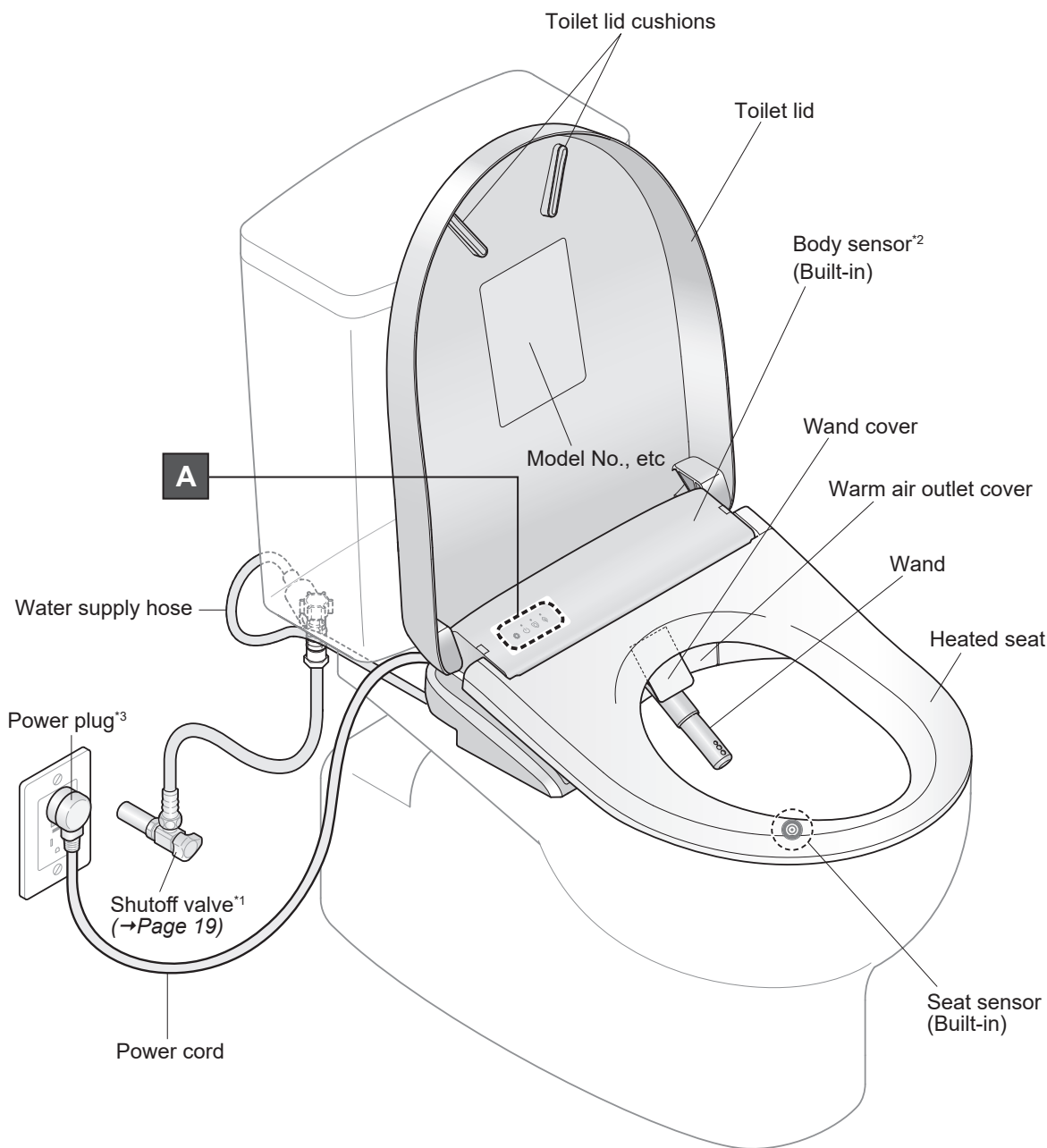

*1 The shape and location vary depending on the type of bowl unit and tank.

*2 Except SW4725

*3 The shape of the power plug may vary.

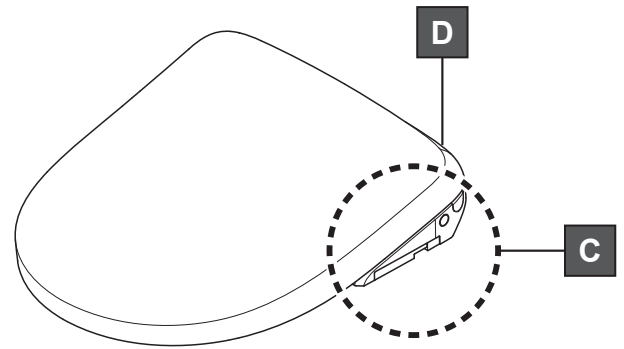
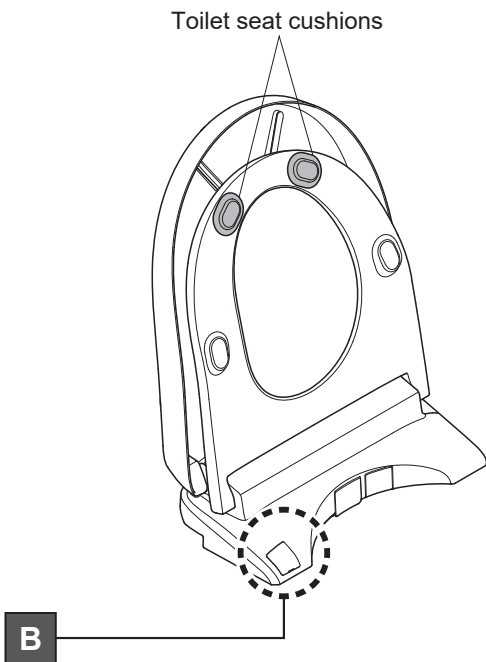

B: Front side of the main unit

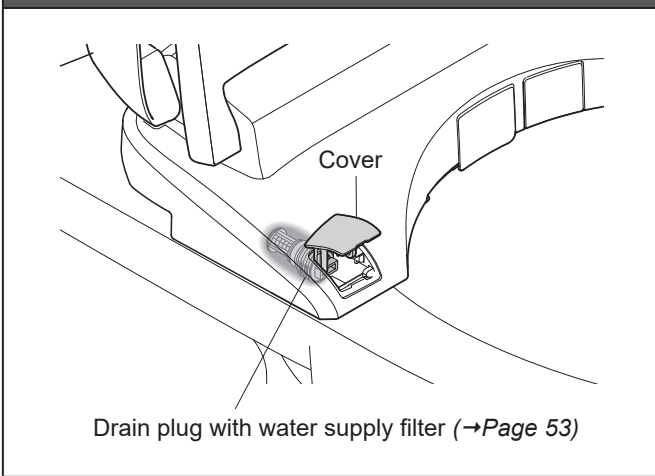

C: Right side of the main unit

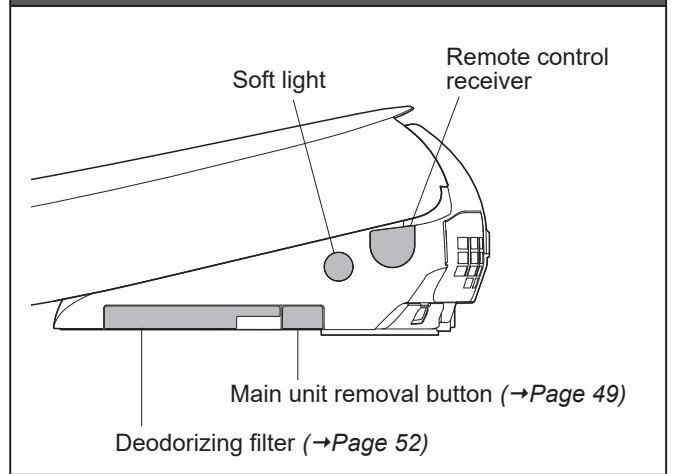

D: Rear side of the main unit

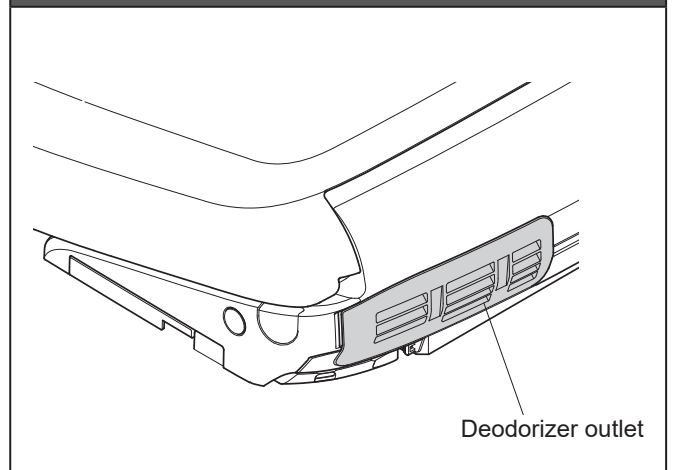

Preparation

Using the Product for the First Time

1. Insert the battery

1.1 Remove the remote control from the hanger.

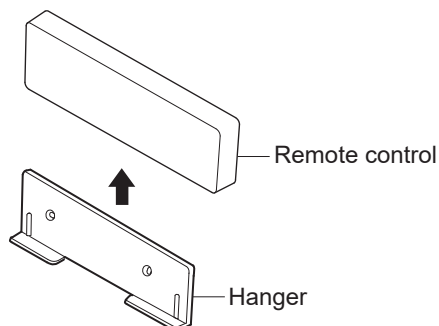

1.2 Open the battery cover and insert two AAA batteries. After inserting batteries, close the battery cover.

Remote control back side

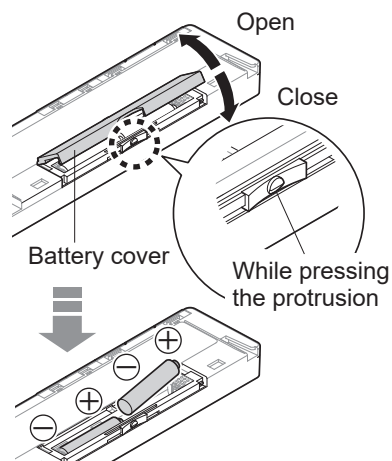

- ▶ When batteries are properly loaded, all the LEDs on the remote control light up for about 2 sec.

1.3 Mount the remote control in the hanger.

About the batterie

Use dry cell, alkaline batteries.

Be sure to follow "Safety Precautions" to prevent the batteries from rupturing or leaking fluid. (→Pages 4,7)

If the remote control is secured to prevent theft

- 1) Hold the remote control and remove the hanger hooks. (two locations, left and right)

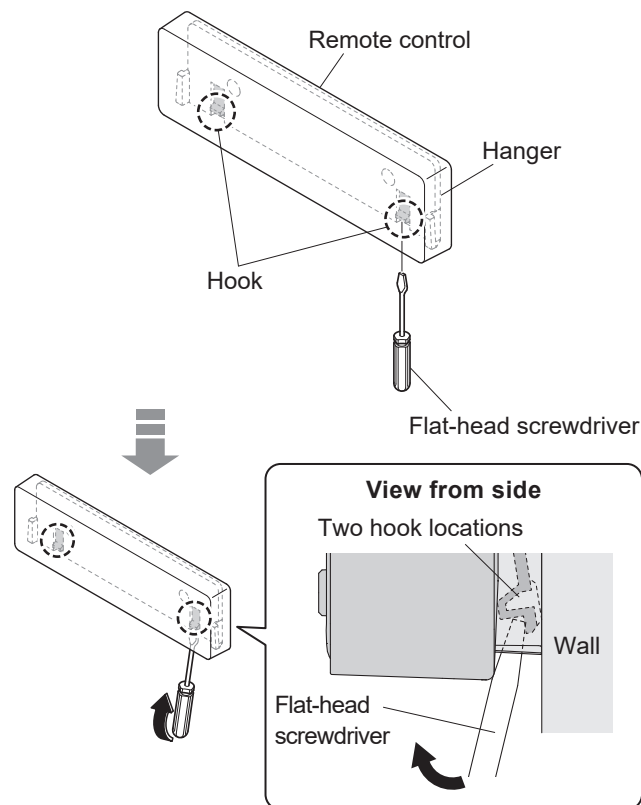

- 2) Remove the remote control from the hanger.

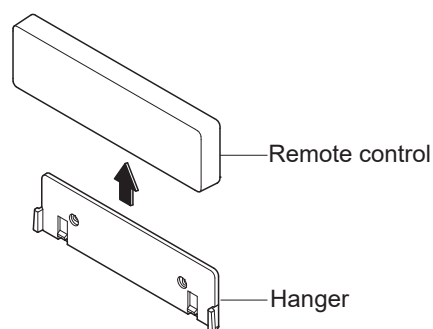

To secure the remote control again

Mount the remote control in the hanger.

2. Turn on the power

2.1 Insert the power plug.

- ▶ The wand extends and then retracts.

2.2 Check the "Power" LED illuminates.

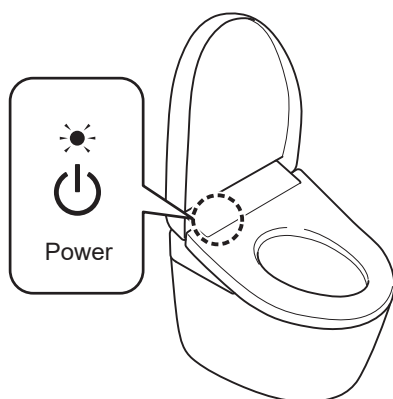

If the light is off

Switch "Power" to "ON" using the remote control.

To operate from the back of remote control

 Press "Power ON/OFF" button about 3 seconds or longer.

To operate from the front of remote control

Recommended if the remote control is secured to prevent theft, etc.

1) and

Press and hold both the "Stop" button and "Water pressure adjustment +" button until the remote control LEDs are lit or flashing. (about 10 seconds)

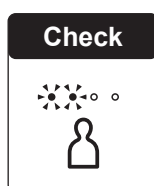

2)

Press "Water pressure adjustment +" button.

3)

Press "Water pressure adjustment -" button.

4)

Press "Water pressure adjustment +" button.

To turn the power "OFF"

Unplug the power plug.

- ▶ The "Power" LED is unilluminated.

3. Open the shutoff valve

3.1 Fully open the shutoff valve.

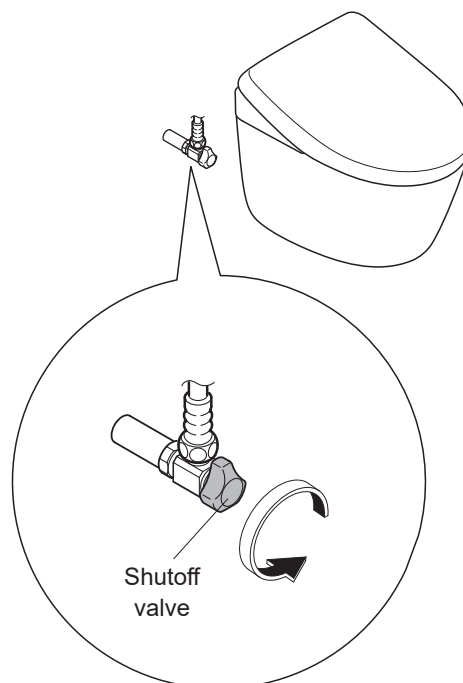

Basic Operations

Mechanism of Auto Functions

"EWATER+" is used automatically to clean the wand and bowl unit.

1. As you approach



Auto open / close
Auto bowl CLEAN

Auto open / close*¹

The toilet lid opens

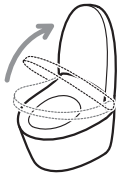

When the toilet is used in standing position

Open the toilet seat with the remote control.

Auto bowl CLEAN

Pre-mist*²



The Bowl light lights up

A mist is automatically sprayed inside the bowl unit to make it more difficult for dirt to adhere.

2. As you sit*³



Deodorizer

Deodorizer

Starts the deodorizer



Removing odors inside the bowl unit.

Note: Deodorizing filter needs regular maintenance. (→Page 52)

3. As you stand up



Auto power deodorizer
Auto flushing
Auto wand CLEAN
Auto bowl CLEAN

Auto power deodorizer

After about 10 seconds

Starts the auto power deodorizer



It stops about 60 seconds after you stand up from the toilet seat

Auto flushing*⁴

After about 10 seconds

The toilet flushes*⁵



Note: The flushing varies depending on how long you sit on the toilet seat.

- Performs a light flush if the time is about 6 to 30 seconds.*⁶
- Performs a full flush if the time is about 30 seconds or longer.

Auto wand CLEAN

Only when the washing functions are used.

After about 25 seconds

The wand extends to clean with the "EWATER+" that comes out of the base*⁷



The Bowl light lights up

Note: "EWATER+" can also be used by pressing the remote control button. (→Page 24 "Wand CLEAN")

Auto bowl CLEAN

After auto wand CLEAN

If the washing functions are not used, after-mist starts after about 25 seconds.

After-mist



The Bowl light lights up

"EWATER+" mist is sprayed on the bowl unit.*⁸

Note: "EWATER+" can also be used by pressing the remote control button. (→Page 48 "Manual spray")

4. As you move away

When you move away



Auto flushing
Auto open / close

Operation under the default settings is described in "Mechanism of Auto Functions".

These mechanisms be changed.
(→Pages 28–46 "Changing Settings")

What is meant by "EWATER+" ?

"EWATER+" helps the self-cleaning wand feature work effectively and by preventing the accumulation of dirt that can cause stains.

- "EWATER+" is generated from chemicals already present in potable water.
- "EWATER+" helps to minimize dirty surfaces, but does not make cleaning unnecessary.
- The effect of rinsing with "EWATER+" can vary depending on the frequency of toilet use and other conditions.

When the toilet is used in standing position

Auto flushing^{*4}

The toilet flushes^{*5*9}



Performs a light flush.^{*6}

Auto open / close^{*1}

The toilet lid and toilet seat close^{*5}



Auto open / close^{*1*10}

The toilet lid closes^{*5}

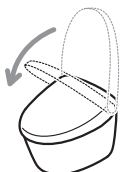

*1 Except SW4726AT40, SW4726, SW4724AT40, SW4724, SW4725

*2 Opening a closed toilet lid on SW4726AT40, SW4726, SW4724AT40, SW4724, or SW4725 activates pre-mist.

*3 Water comes out from the area around the wand for several seconds while water is warmed up.

*4 Available only when "Flush" button is located on the top side of the remote control. (→Page 24)

*5 You can change to the setting that closes the toilet lid before flushing the bowl unit. (→Page 34)

*6 A full flush will be used depending on the type of bowl unit.

*7 When the washing functions (Rear washing and Front washing etc.) have not been used in 8 hours, the wand is cleaned automatically. (Water comes out from around the wand.)

*8 When the washing feature (Rear washing and Front washing etc.) is not used for about 8 hours, mist is sprayed on the bowl unit automatically.

*9 If SW4726AT40, SW4726, SW4724AT40, or SW4724 is used from a standing position, "Auto flushing" is not activated.

*10 When you do not sit on the toilet seat, or when you sit on it or stand in front of the bowl unit briefly, it takes about 5 minutes before the lid closes automatically.

Basic Operations

Mechanism of Auto Functions

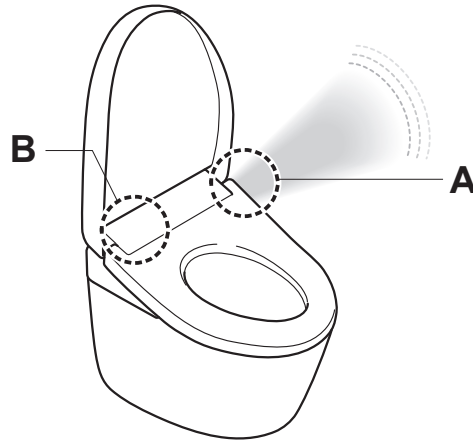

A Soft light

Lighting up the inside of the bathroom with a soft light.

It lights up as you approach the bowl unit and goes off after you move away from the unit and a certain time has passed.

Note: You can turn "Soft light" ON or OFF.
(→Page 42)

Night light

You can change "Soft light" and "Bowl light" to "Night mode", a lighting mode suitable for night. (→Page 41)

B CLEAN indicator

Lights to show that the "Auto bowl CLEAN", "Deodorizer", "Auto wand CLEAN", and "Manual spray" functions are operating.

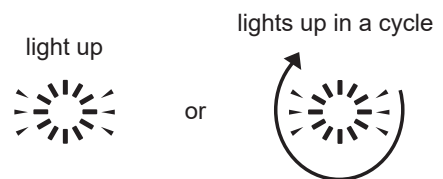

Lights only when the toilet seat is not in-use*1

Note: You can turn "CLEAN indicator" ON or OFF.
(→Page 43)



*1 Except "Manual spray"

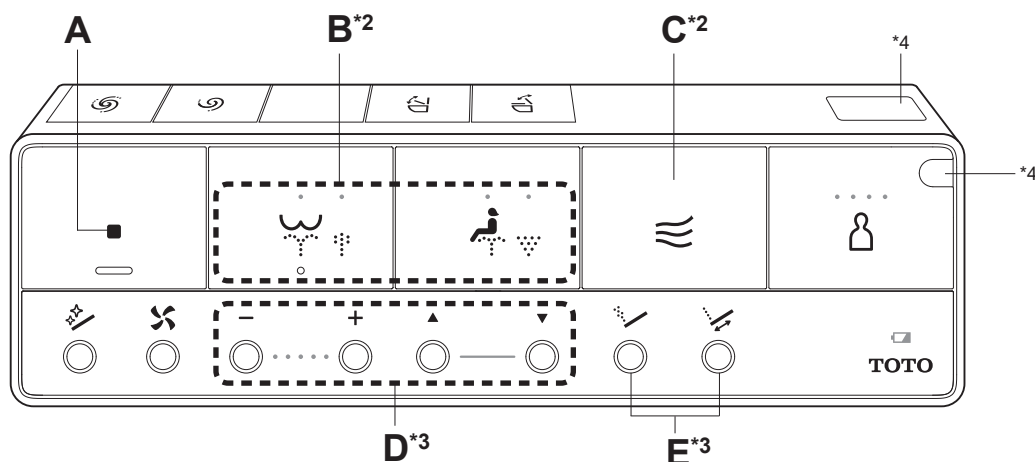

Using the Remote Control





Operate the controls on the remote control; a beep sounds when the main unit receives the signal.



A  **Stop**
Stops the B or C operation.

B  **Rear washing**
Washes your rear.
 **Rear soft washing**
Washes your rear with soft embracing water flow.

The setting changes between  and  each time the  is pressed.



 **Front washing**
Serves as a bidet for ladies.

 **Wide front washing**
Gently washes a wide area.





The setting changes between  and  each time the  is pressed.

C  **Warm air drying**
Dries your rear.

D **Water pressure adjustment**

  You can adjust the water pressure to one of five levels.
[-] Softer, [+] Stronger
After you press the "Water pressure adjustment" button, the set position will light for 10 seconds.



Wand position adjustment

  You can adjust the washing position to 5 different points between the front and the rear, using the [] and [] buttons.

Once use of the remote control is finished, the settings will return to the initial setting (3rd position) after a while, not exceeding a maximum of 5 minutes.

If you do not want to return to 3rd position (→Page 44)

Note: *Sitting back on the toilet seat makes it easier to adjust the wand position and to reduce splashing.*

E  **Pulsating washing**
Washes with the water pressure pulsating between soft and strong.

 **Oscillating washing**
The wand moves back and forth to washes your rear thoroughly.

Note: *Sitting back on the toilet seat makes it easier to adjust the wand position and to reduce splashing.*

*2 This cannot be used if the seat sensor is not working. Sit down so that the seat sensor touches your skin directly. (→Page 9)

*3 While using B, these buttons and their functions can be operated.

*4 Remote control transmitter

Basic Operations

Using the Remote Control (Continued)

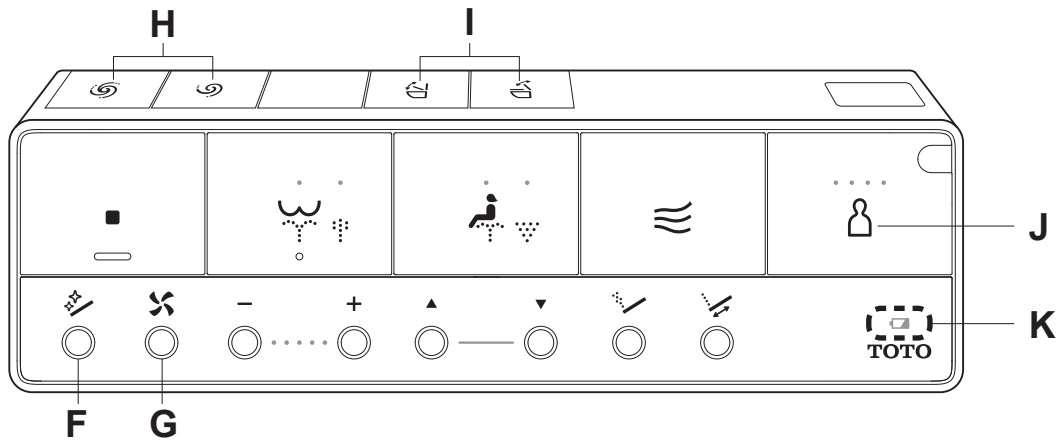

F  **Wand CLEAN**
 Cleans the wand with "EWATER+"*1
 After wand cleaning, water comes out from around the wand.
Note: This function will operate automatically after using the washing functions (Rear washing, Front washing, etc.). (→Pages 18, 39 "Auto wand CLEAN")
Note: To clean the wand with it extended. (→Page 51 "Wand cleaning")

G  **Power deodorizer**
 Press the button to increase suction power and remove odor.
 Cannot be used unless you are seated on the toilet seat.
 Stops automatically in 60 seconds if left running.

H **Flushing***2
 The type of button varies depending on the type of bowl unit or tank.

 **Full flush***3
 Performs a full flush.

 **Light flush***3
 Performs a light flush.

Full flush/Light flush **Full flush**

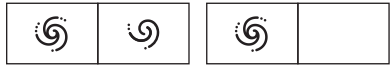

Toilet flush button not included





I **Opening/closing the toilet seat and lid***4
 For models with the "Auto open/close" function, the remote control can also be used for operation.

 **Opening and closing the toilet lid**
 Opens and closes the toilet lid.

 **Opening and closing the toilet seat**
 Opens and closes the toilet seat.

With "Auto open / close" **Without "Auto open / close"**



J  **Personal setting**
 Up to four people can register their preferred "Water pressure", "Wand position" and "Warm water temperature" settings. (→Pages 44, 45)

To use

- 1) Press the button to turn on the LED for the location of your setting.
 - ○ ○ ○ Register 1
 - ● ○ ○ Register 2
 - ● ● ○ Register 3
 - ● ● ● Register 4
- 2) Press the wash button you want to use ("Rear washing", etc.)

K  **Low battery warning mark**
 (→Page 54)

*1 What is meant by "EWATER+"? (→Page 21)
 *2 Available only when "Flush" button is located on the top side of the remote control. (→Page 24)
 *3 You can change to the setting that closes the toilet lid before flushing the bowl unit. (→Pages 34–36)
 *4 Except SW4726AT40, SW4726, SW4724AT40, SW4724, SW4725

Remote control back side

How to remove the remote control (→Page 18)

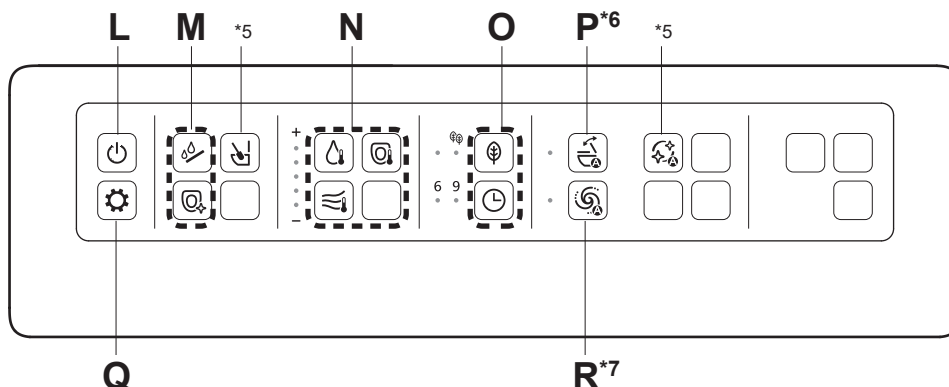

Operate the controls on the remote control; a beep sounds when the main unit receives the signal.

This section is an overview of the settings that can be configured with the remote control. See the corresponding pages for the detailed descriptions.

L

"Power ON/OFF" button
 Press and hold for 3 seconds or longer to turn washlet operation ON/OFF.
 ► If the remote control is secured to prevent theft.
 (→Page 19 Step 2-2.2)





M

Wand cleaning
 (→Page 51)

Manual spray
 "EWATER+"^{*1} mist is sprayed on the bowl unit.

Note: It cannot be used when the wand is out or when you are sitting on the toilet seat.



N

Warm water temperature

Toilet seat temperature

Drying air temperature

Adjust temperatures (→Pages 26, 27)







O

Auto energy saver / Auto energy saver+

Timer energy saver

Saving energy (→Pages 32, 33)

P

Auto open/close ON/OFF^{*6}
 Changing Settings (→Page 37)



Q

Setting confirmation
 The current setting can be discerned from the LEDs.



R

Auto flushing ON/OFF^{*7}
 Changing Settings (→Page 33)



*5 The button is not used with this product, so pressing it does not perform operations.

*6 SW4726AT40, SW4726, SW4724AT40, SW4724, and SW4725 are equipped with the button, but it cannot be used.

*7 The button (if any) cannot be used when the "Flush" button is not located on the top side of the remote control.

Temperature Adjustment

Warm Water, Toilet Seat, Drying

Five different temperature levels from high to low and "OFF" can be set.

Remote control back side

How to remove the remote control (→Page 18)

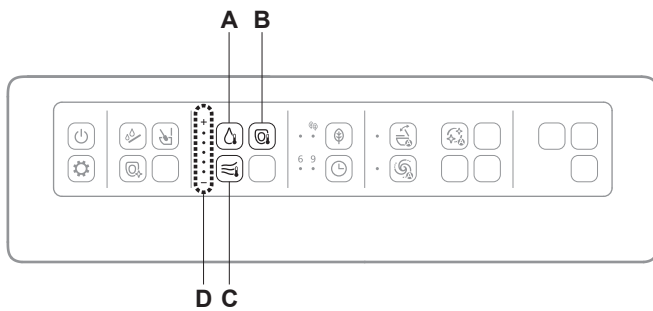

- A Warm water temperature button**
(When you want to adjust the warm water temperature)
- B Toilet seat temperature button**
(When you want to adjust the toilet seat temperature)
- C Drying air temperature button**
(When you want to adjust the drying air temperature)
- D Displaying the temperature level of the pressed button**

Adjusting the temperature

- 1.** Remove the remote control from the hanger.
 - ▶ If the remote control is secured to prevent theft. (→Page 18)
- 2.** Choose and press the button of the temperature that you want to set from the ("Toilet seat temperature" button), ("Warm water temperature" button) and (Drying air temperature button).
 - ▶ The current temperature level appears.

- 3.** Press the button selected in step 2 repeatedly until a desired temperature level illuminates.

▶ The setting changes each time the button is pressed once

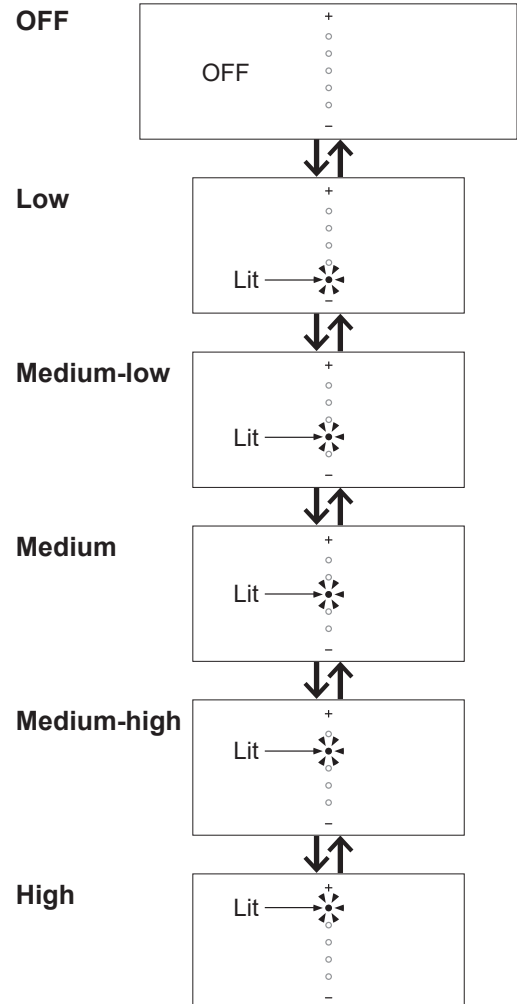

If adjusting the temperature does not warm up the toilet seat.

▶ Is the energy saver set to "ON"? (→Pages 30, 31)

Settings complete

- ▶ When seat temperature is set, the SEAT LED illuminates.



Note: The "Drying" cannot be turned "OFF".
 If the button is not pressed for about 10 seconds, the "Temperature adjustment" LED will go off, but the setting will be retained.
 If the "Temperature adjustment" LED goes out before the setting is completed, start all over again at step 2.

4. Mount the remote control in the hanger.

- ▶ If the remote control is secured to prevent theft. (→Page 18)

To turn the warm water temperature*1 and toilet seat temperature "OFF"

1. Remove the remote control from the hanger.

- ▶ If the remote control is secured to prevent theft. (→Page 18)

2. Select a temperature button you want to turn "OFF" from ("Toilet seat temperature" button), ("Warm water temperature" button) and press it.

- ▶ The current temperature level appears.

3. Press the button selected in step 2 repeatedly until the temperature level is set to "OFF".

- ▶ The setting changes each time the button is pressed once

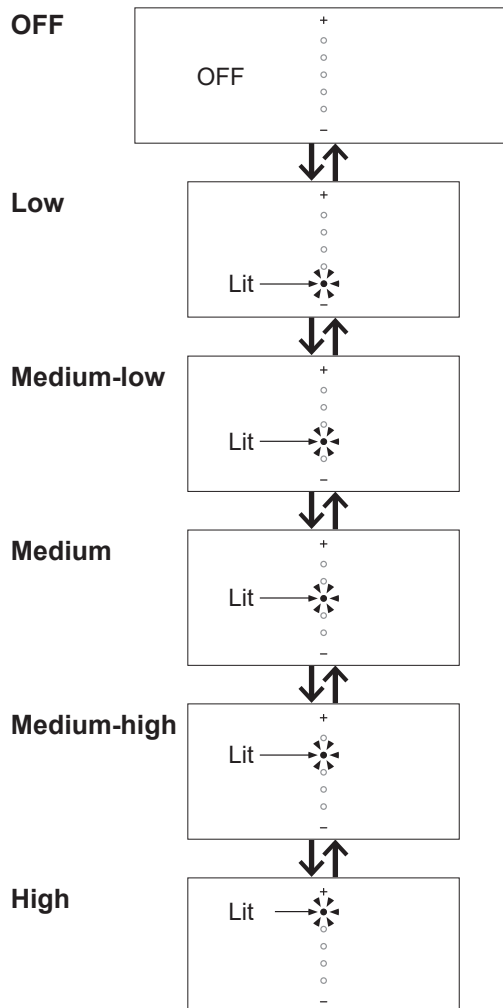

Settings complete

- ▶ When seat temperature is OFF, the SEAT LED is unilluminated.



Note: The "Drying" cannot be turned "OFF".

4. Mount the remote control in the hanger.

- ▶ If the remote control is secured to prevent theft. (→Page 18)

*1 To prevent condensation, the water temperature does not drop below 68 °F (20 °C) even when set to "OFF".

Changing Settings

Setting List

Setting Types	Available Settings Bold: Initial settings	Applicable Models	
Auto energy saver (→Page 32)	ON/OFF	All models	
Auto energy saver+ (→Page 32)	ON/OFF		
Timer energy saver (→Page 33)	6H/9H/OFF		
Auto flushing (→Page 33)	ON/OFF	SW4736AT40*1, SW4736*1 SW4734AT40*1, SW4734*1	
Auto flush delay (→Page 34)	SET1/SET2/SET3	SW4726AT40*1, SW4726*1 SW4724AT40*1, SW4724*1	
Auto flush lid closed (→Page 34)	ON/OFF	SW4736AT40*1, SW4736*1 SW4734AT40*1, SW4734*1	
Auto flush lid relation (→Page 36)	ON/OFF	SW4726AT40*1, SW4726*1 SW4724AT40*1, SW4724*1	
Auto open / close (→Page 37)	ON/OFF	SW4736AT40, SW4736 SW4734AT40, SW4734 SW4735	
Auto close delay (→Page 37)	SET1/SET2		
Auto open delay (→Page 38)	SET1/SET2/SET3		
Seat/lid (→Page 38)	Lid/Seat·Lid		
Auto wand CLEAN (→Page 39)	ON/OFF	All models	
Auto bowl CLEAN (→Page 39)	ON/OFF		
Deodorizer (→Page 40)	ON/OFF		
Auto power deodorizer (→Page 40)	ON/OFF		
Night light (→Page 41)	ON/STANDBY/TIMER		
Soft light (→Page 42)	ON/OFF		
Bowl light (→Page 42)	ON/OFF		
CLEAN indicator (→Page 43)	ON/OFF		
Beep sound (→Page 43)	ON/OFF*2		
Pressure/position setting (→Page 44)	ON/OFF		
Personal setting (→Page 44)	ON/OFF		
Registering Personal Settings (→Page 45)	Register 1/Register 2/Register 3/Register 4		
Sensor detection range (→Page 46)	SET1/SET2/SET3/SET4/SET5		SW4736AT40, SW4736 SW4734AT40, SW4734 SW4735

*1 Available only when "Flush" button is located on the top side of the remote control. (→Page 24)

*2 The beep sounds when settings are being changed, even if the beep noise is turned off. (except for "Pressure/position setting" or "Personal setting")

Setting with buttons on the front of the remote control

Press the button indicated in step 1 for approximately 10 seconds or longer to enter setting mode.

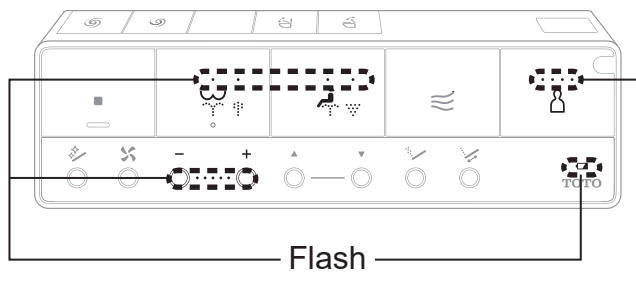

Check

■ Press "Stop" button about 10 seconds or longer. 

■ and + Press "Stop" button and "Water pressure adjustment +" button at the same time about 10 seconds or longer. 

Note: During setting, if the next button is not pressed within about 60 seconds, the light will stop flashing. If you fail to complete the setting, redo from the step 1.

Setting with buttons on the back of the remote control

Remote control back side

How to remove the remote control (→Page 18)

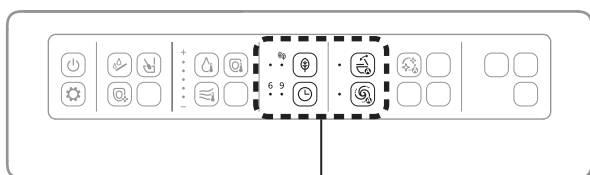

Use the LED to check settings.

▶ Setting buttons (→Pages 32–46)

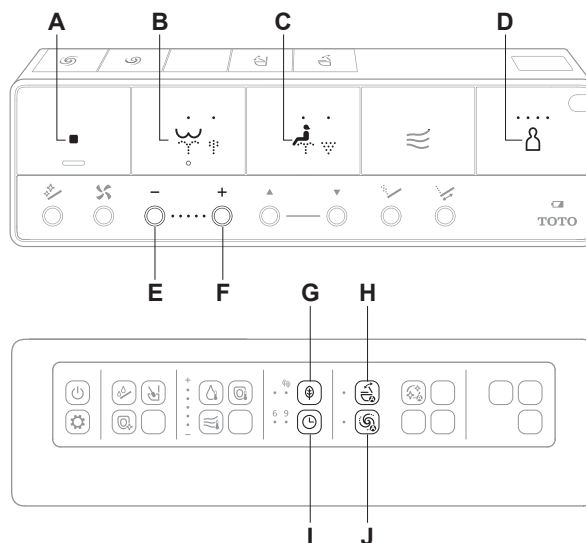

- A Stop button
- B Rear washing button
- C Front washing button
- D Personal setting button
- E Water pressure adjustment - button
- F Water pressure adjustment + button
- G Auto energy saver button
- H Auto open / close button
- I Timer energy saver button
- J Auto flushing button

Changing Settings

The energy saver features

"Auto energy saver", "Auto energy saver+" or "Timer energy saver" can be selected.

To save energy, the temperature of the toilet seat becomes low (or "OFF").

Note: Even if the energy saver is activated (with the toilet seat heater set to Low or OFF), the toilet seat will be temporarily heated when you sit on it. (To reach the set temperature, the toilet seat takes about 15 minutes.) The LED indication on the main display returns to the state for when the energy saver is on.

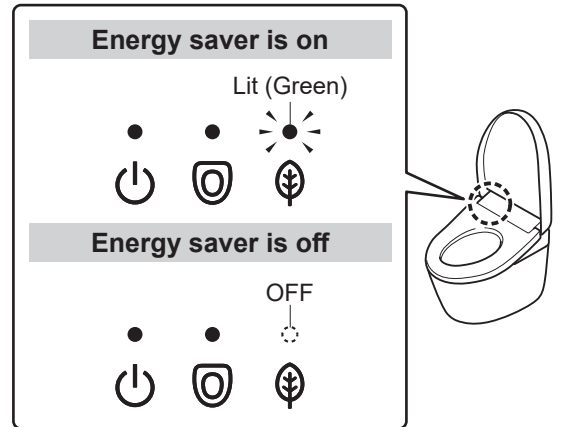

Auto energy saver

You want the product to save energy automatically

The product detects time periods with infrequent use and lowers the toilet seat temperature automatically.

It takes about 10 days for the product to determine the periods when it is used relatively less frequently.

When energy saver is in operation

Main display

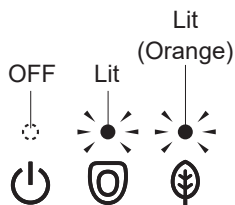

Toilet seat heater



Auto energy saver+

You want to save more energy

In addition to the "Auto energy saver" feature, it automatically turns off the toilet seat heater during time periods when the toilet is not used.

When energy saver is in operation

Main display

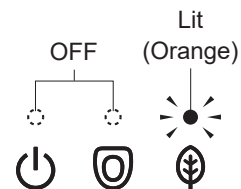

Toilet seat heater

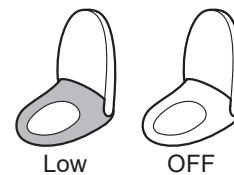

Example

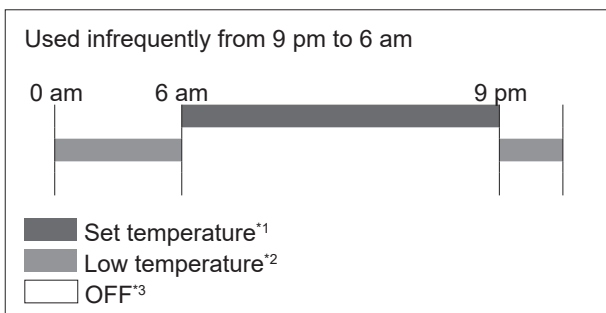

Example

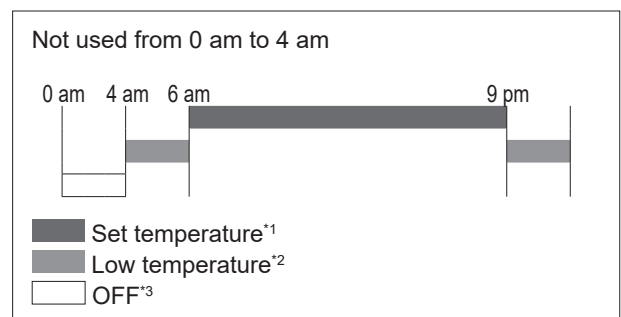

*1 The toilet seat temperature settings on pages 26, 27.

*2 The time period when the toilet seat heater is set to a "Low".

*3 The time period when the toilet seat heater is set to a "OFF"

Timer energy saver

You want to save energy only for a preset duration of time. (6 hours, 9 hours)

Once the time is set, the toilet seat heater turns off automatically during the set time period every day.

When energy saver is in operation

Main display

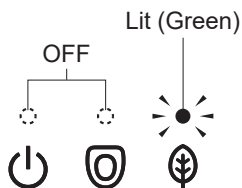

Toilet seat heater



Example

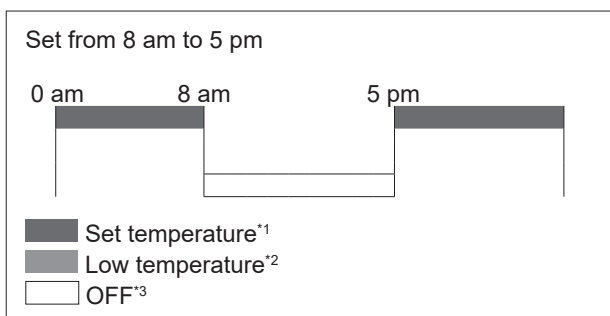

Timer energy saver and Auto energy saver / Auto energy saver+

You want to save the maximum amount of energy possible?

When both "Timer energy saver" and "Auto energy saver / Auto energy saver+" are set, "Auto energy saver / Auto energy saver+" operates when "Timer energy saver" is not operating.

When energy saver is in operation

Main display

During "Auto energy saver / Auto energy saver+":

- ▶ Same LED indication as "Auto energy saver / Auto energy saver+" (→Page 30)

During "Timer energy saver":

- ▶ Same LED indication as "Timer energy saver" (→See the description on the left)

Toilet seat heater

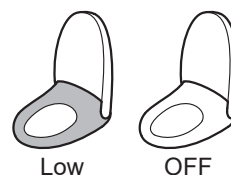

Example

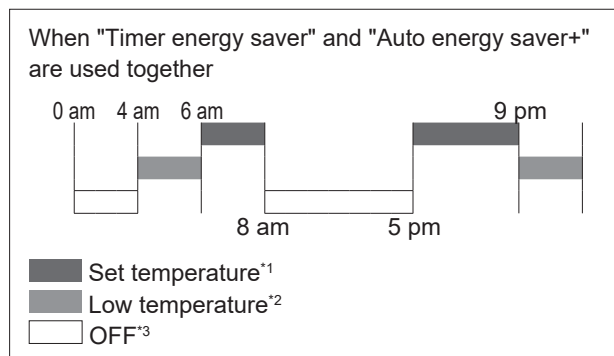

Changing Settings

How to Set

Auto energy saver

1. 

Press "Auto energy saver" button.

► The setting changes each time the button is pressed once.

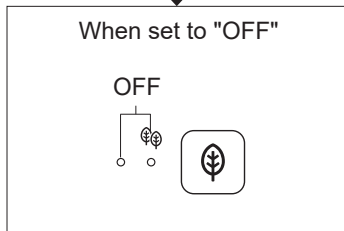
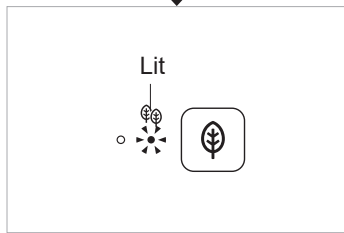
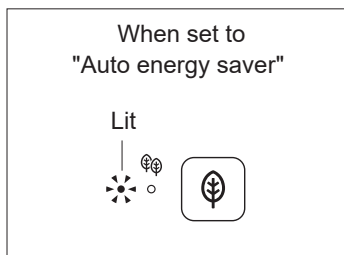

Settings complete

Auto energy saver+

1. 

Press "Auto energy saver+" button.

► The setting changes each time the button is pressed once.

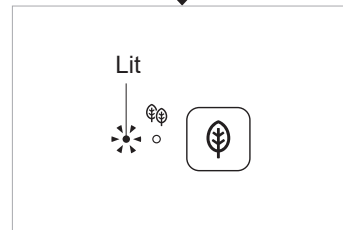
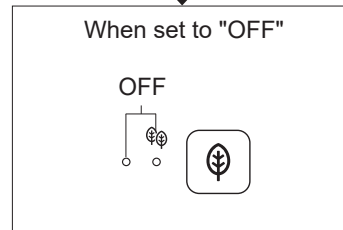
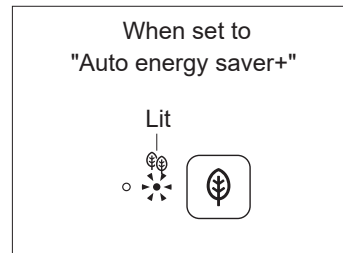

Settings complete

Timer energy saver

Set the "Timer energy saver" at the time you want to start it.

Example: To save energy from 1 am to 7 am (for 6 hours)

1.

When the time of the day reaches 1:00 am at night, press "Timer energy saver" button.

Press the "Timer energy saver" button repeatedly until the "6" LED illuminates.

- ▶ The setting changes each time the button is pressed once.

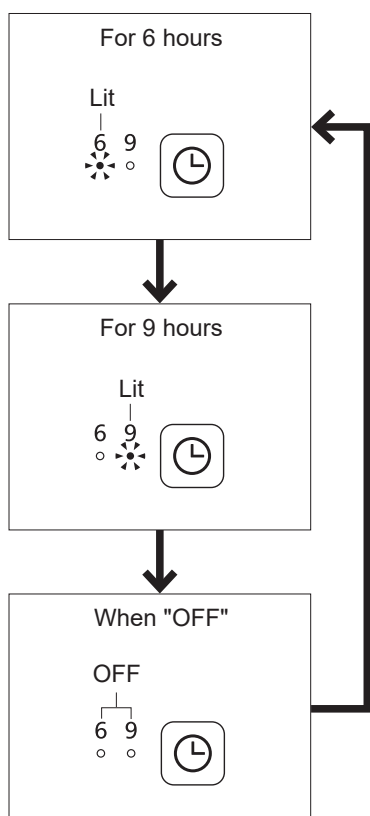

Settings complete

Auto flushing

Set whether or not to clean the bowl unit automatically

1.

Press "Auto flushing" button.

- ▶ The setting changes each time the button is pressed once.

Set whether or not to clean the bowl unit automatically.

Check the "Auto flushing" LED (→Page 29)

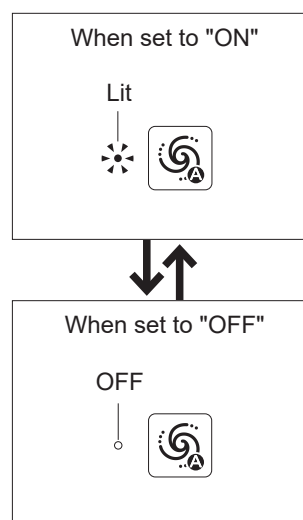

Settings complete

Changing Settings

Auto flush delay*1

Change the amount of time before the toilet flushes automatically

1. ■

Press "Stop" button until all LEDs on the remote control are lit or flashing. (about 10 seconds)

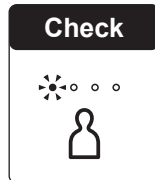

2.

Press "Rear washing" button.

3.

Press "Front washing" button.

4. Choose and press the button of the item that you want to set.*2

Change the amount of time before the toilet flushes automatically.

When set to "SET1" Press "Water pressure adjustment -" button. - Short beeps	When set to "SET2" Press "Rear washing" button. Long beep	When set to "SET3" Press "Water pressure adjustment +" button. + Short beep
---	---	--

- SET 1 (Short) : After about 5 seconds
- SET 2 (Standard) : After about 10 seconds
- SET 3 (Long) : After about 15 seconds

Note: If "Auto flush lid closed" is turned ON, the toilet lid closes before flushing the bowl unit as above.

Settings complete

Auto flush lid closed

Set whether or not to close the toilet lid automatically before flushing the bowl unit

1. ■

Press "Stop" button until all LEDs on the remote control are lit or flashing. (about 10 seconds)

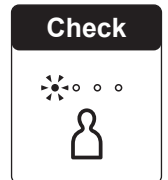

2.

Press "Rear washing" button.

3. +

Press "Water pressure adjustment +" button.

4. Choose and press the button of the item that you want to set.

When set to "ON" Press "Rear washing" button. Short beep	When set to "OFF" Press "Front washing" button. Long beep
--	---

Settings complete

*1 The length of time specified for "Auto close delay (Auto flush lid closed)" if "Auto flush lid closed" is turned ON.
 (If the "Flush" button is located on the top side of the remote control for SW4736AT40, SW4736, SW4734AT40, or SW4734)
 *2 If "Auto flush lid relation" is set to "ON", the bowl unit automatically flushes about 25 seconds for [STEP1] (Short), 30 seconds for [STEP2] (Standard), or 35 seconds for [STEP3] (Long) after leaving the toilet without closing the toilet lid.
 (If the "Flush" button is located on the top side of the remote control for SW4726AT40, SW4726, SW4724AT40, or SW4724)

About "Auto flush lid closed"...
 (If the "Flush" button is located on the top side of the remote control for SW4736AT40, SW4736, SW4734AT40, or SW4734)

About 10 seconds after you stand up or move away if you use the toilet in standing position, the toilet lid closes automatically before flushing the bowl unit.
 Also, if you press the Flush buttons ("Full flush" or "Light flush")^{*3} on the remote control, the toilet lid closes before flushing the bowl unit.

Using the toilet seat

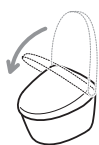

Stand up

The toilet lid closes in about 10 seconds.
 ► The toilet lid closes before flushing the bowl unit.

Using the toilet in standing position



Move away

The toilet seat and lid close when you move away.
 ► The toilet seat and lid close before flushing the bowl unit.^{*4}

Using the flush buttons on the remote control

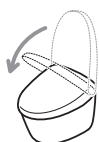

Press

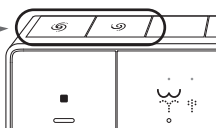

The toilet lid closes.
 ► The toilet lid closes before flushing the bowl unit.

"Auto flush lid closed" does not work if "Auto flushing" and "Auto open / close" are set as below: (Except when using the Flush buttons on the remote control)

	Auto flushing	Auto open / close
1)	OFF	ON
2)	ON	OFF
3)	OFF	OFF

- 1) The toilet lid closes automatically but the bowl unit does not flush.
- 2) The bowl unit flushes automatically but the toilet lid does not close.
- 3) The toilet lid does not open / close and the bowl unit does not flush automatically.

Turn both "Auto flushing" and "Auto open / close" ON.
 (→Pages 33, 37)

Even if "Auto flushing" is turned ON, "Auto flush lid closed" may not work in some cases. For details, refer to "Auto flush lid closed" does not work" in "Troubleshooting". (→Page 64)

Note: You can change the length of time before water flushes after closing the toilet lid automatically to [SET 1] (Short), [SET 2] (Standard), or [SET 3] (Long). (→Page 34)
 If you get up slightly from the seat or sit leftward on the seat while seated on it, the seat sensor may not detect properly, which results in the toilet lid being closed and bowl unit being flushed. Sit down so that the seat sensor touches your skin directly. (→Page 9)
 While using the toilet in standing position, the toilet lid may close and the bowl unit may be flushed. Stand straight in front of the bowl unit.

*3 The type of button varies depending on the type of bowl unit or tank. (→Page 24)

*4 The toilet seat and lid close in about 30 seconds and then the bowl unit flushes.

Changing Settings

Auto flush lid relation

Close the toilet lid before flushing the bowl unit ON/OFF

1. ■

Press "Stop" button until all LEDs on the remote control are lit or flashing. (about 10 seconds)

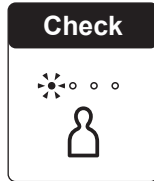

2. 



Press "Rear washing" button.

3. +

Press "Water pressure adjustment +" button.

4. Choose and press the button of the item that you want to set.

Close the toilet lid before flushing the bowl unit

<p>When set to "ON"</p> <p>Press "Rear washing" button.</p>  <p>Short beep</p>	<p>When set to "OFF"</p> <p>Press "Front washing" button.</p>  <p>Long beep</p>
---	--

Settings complete

About "Auto flush lid relation"

(If the "Flush" button is located on the top side of the remote control for SW4726AT40, SW4726, SW4724AT40, or SW4724)

When the toilet lid is closed by hand, the bowl unit flushes in conjunction with the movement of the toilet lid.

If the toilet lid is not closed, the bowl unit flushes automatically about 30 seconds after the user stands up in order to ensure flushing.

(If "Auto flushing" (→page 33) is turned ON)

You can change the length of time before the bowl unit flushes after leaving the toilet without closing the toilet lid to [STEP1] (Short), [STEP2] (Standard), or [STEP3] (Long). (→Page 34)

Auto open / close

Set whether or not to open and close the toilet lid automatically



Press "Auto open / close" button.

- ▶ The setting changes each time the button is pressed once.

Set whether or not to open and close the toilet lid automatically.

Check the "Auto open/close" LED (→Page 29)

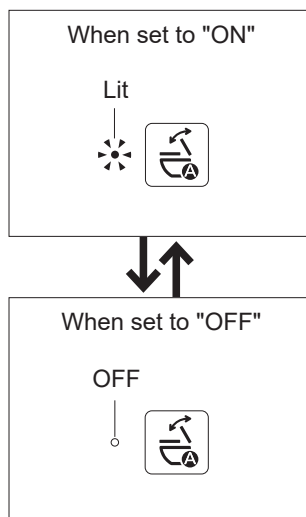

Settings complete

Auto close delay*1

Change the amount of time before the lid/seat closes automatically



Press "Stop" button until all LEDs on the remote control are lit or flashing. (about 10 seconds)

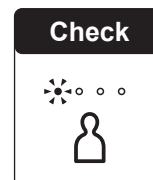

Press "Front washing" button.



Press "Rear washing" button.

4. Choose and press the button of the item that you want to set.

Change the amount of time before the lid/seat closes automatically.

When set to "SET1"*2 Press "Water pressure adjustment -" button. - Short beep	When set to "SET2" Press "Water pressure adjustment +" button. + Long beep
--	---

SET 1 (Short) : After about 25 seconds

SET 2 (Standard) : After about 90 seconds

Settings complete

*1 If "Auto flush lid closed" is turned ON, you cannot use this setting to change the length of time before closing the toilet lid automatically. Configure the settings for "Auto flush delay". (→Page 34) (If the "Flush" button is located on the top side of the remote control for SW4736AT40, SW4736, SW4734AT40, or SW4734)

*2 When set to "SET 1 (Short)", the lid/seat does not open automatically for about 15 seconds after closing automatically.

Changing Settings

Auto open delay

Change the time period till automatic opening
(After closing by hand or remote control.)

- 

Press "Stop" button until all LEDs on the remote control are lit or flashing.
(about 10 seconds)

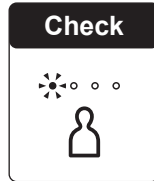

- 



Press "Front washing" button.

- 

Press "Water pressure adjustment +" button.

- Choose and press the button of the item that you want to set.

Change the time period till automatic opening.

When set to "SET1" Press "Rear washing" button.  Long beep	When set to "SET2" Press "Front washing" button.  Short beep	When set to "SET3" Press "Water pressure adjustment -" button. - Short beeps
--	--	---

- SET 1 (Standard) : After about 15 seconds
- SET 2 (Middle) : After about 30 seconds
- SET 3 (Long) : After about 90 seconds

Settings complete

Seat/lid

Automatically open and close the toilet lid/
Automatically open and close the toilet seat and toilet lid

- 

Press "Stop" button until all LEDs on the remote control are lit or flashing.
(about 10 seconds)

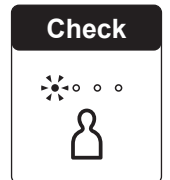

- 



Press "Front washing" button.

- 

Press "Water pressure adjustment -" button.

- Choose and press the button of the item that you want to set.

**Automatically open and close the toilet lid/
Automatically open and close the toilet seat and toilet lid.**

When set to "Lid" Press "Rear washing" button.  Long beep	When set to "Seat-Lid" ^{*1*2} Press "Front washing" button.  Short beep
--	--

Settings complete

*1 When "Seat and lid" are set to open automatically, pre-mist is not sprayed.

*2 When "Seat and lid" are set, a light flush may be performed even if you do not stand and use it, depending on the layout of your toilet.

Auto wand CLEAN

Set whether or not to clean the wand automatically

- 

Press "Stop" button until all LEDs on the remote control are lit or flashing. (about 10 seconds)

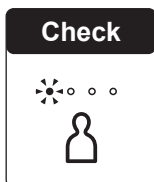

- 

Press "Water pressure adjustment +" button.

- 

Press "Rear washing" button.

- Choose and press the button of the item that you want to set.

Set whether or not to clean the wand automatically.

<p>When set to "ON"</p> <p>Press "Water pressure adjustment +" button.</p> <p style="text-align: center;">+</p> <p>Short beep</p>	<p>When set to "OFF"</p> <p>Press "Water pressure adjustment -" button.</p> <p style="text-align: center;">-</p> <p>Long beep</p>
--	--

Settings complete

Auto bowl CLEAN

Set whether or not to spray mist in the bowl unit automatically

- 

Press "Stop" button until all LEDs on the remote control are lit or flashing. (about 10 seconds)

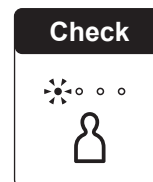

- 

Press "Water pressure adjustment +" button.

- 

Press "Front washing" button.

- Choose and press the button of the item that you want to set.

Set whether or not to spray mist in the bowl unit automatically.

<p>When set to "spray"</p> <p>Press "Water pressure adjustment +" button.</p> <p style="text-align: center;">+</p> <p>Short beep</p>	<p>When set to "do not spray"</p> <p>Press "Water pressure adjustment -" button.</p> <p style="text-align: center;">-</p> <p>Long beep</p>
---	---

Settings complete

Changing Settings

Deodorizer

Set whether or not to deodorize automatically after sitting on the toilet seat

1. ■

Press "Stop" button until all LEDs on the remote control are lit or flashing. (about 10 seconds)

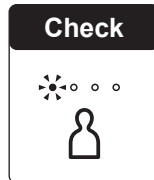

2. -

Press "Water pressure adjustment -" button.

3.

Press "Front washing" button.

4. Choose and press the button of the item that you want to set.

Set whether or not to deodorize automatically after sitting on the toilet seat.

When set to "ON" Press "Water pressure adjustment +" button. + Short beep	When set to "OFF" Press "Water pressure adjustment -" button. - Long beep
--	--

Settings complete

Auto power deodorizer

Set whether or not to power deodorize automatically after standing up

1. ■

Press "Stop" button until all LEDs on the remote control are lit or flashing. (about 10 seconds)

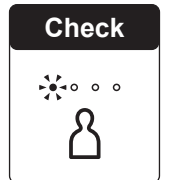

2. -

Press "Water pressure adjustment -" button.

3. +

Press "Water pressure adjustment +" button.

4. Choose and press the button of the item that you want to set.

Set whether or not to power deodorize automatically after standing up

When set to "ON" Press "Rear washing" button. Short beep	When set to "OFF" Press "Front washing" button. Long beep
--	---

Settings complete

Night light

Set whether or not to change "Soft light" and "Bowl light" to "Night mode", a lighting mode suitable for night, as well as the time window.

To set the time window (timer), set the desired start time.

1. ■ and +

Press and hold both the "Stop" button and "Water pressure adjustment +" button until the remote control LEDs are lit or flashing. (about 10 seconds)

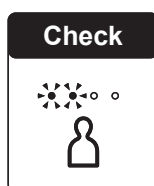

2.

Press "Front washing" button.

3. +

Press "Water pressure adjustment +" button.

4. Choose and press the button of the item that you want to set.

<p>When set to "ON" ON</p> <p>Press "Rear washing" button.</p> <p>Short beep</p>	<p>When set to "OFF" OFF [STANDBY]</p> <p>Press "Front washing" button.</p> <p>Long beep</p>	<p>When set to "the time window" TIMER</p> <p>Press "Water pressure adjustment -" button.</p> <p>—</p> <p>Short beep</p>
--	--	--

Settings complete

About "Night light"...

You can change "Soft light" and "Bowl light" to "Night mode", a lighting mode suitable for night.

Note: The light does not turn on if "Soft light" and "Bowl light" are turned OFF.

The "Night light" is turned ON

Soft light

Always lights up



Bowl light

Lights up only while someone is detected



The brightness changes according to human movement.

The "Night light" is turned OFF [STANDBY]

Soft light

Lights up as specified in the settings



Bowl light

Lights up as specified in the settings



The "Night light" is configured with the timer



The light turns ON / OFF [STANDBY] every 12 hours starting from the set time.

Example

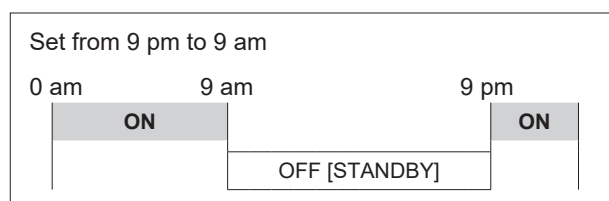

Changing Settings

Soft light

Set whether or not to use the soft light

1.  and **+**

Press and hold both the "Stop" button and "Water pressure adjustment +" button until the remote control LEDs are lit or flashing. (about 10 seconds)

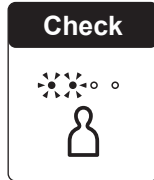

2. 

Press "Rear washing" button.

3. 

Press "Front washing" button.

4. Choose and press the button of the item that you want to set.

Set whether or not to use the soft light.

<p>When set to "ON"</p> <p>Press "Water pressure adjustment +" button.</p> <p>+</p> <p>Short beep</p>	<p>When set to "OFF"</p> <p>Press "Water pressure adjustment -" button.</p> <p>-</p> <p>Long beep</p>
--	--

Settings complete

Bowl light

Set whether or not to use the light inside the bowl unit

1.  and **+**

Press and hold both the "Stop" button and "Water pressure adjustment +" button until the remote control LEDs are lit or flashing. (about 10 seconds)

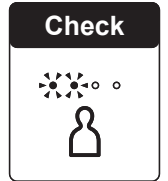

2. 



Press "Rear washing" button.

3. **+**

Press "Water pressure adjustment +" button.

4. Choose and press the button of the item that you want to set.

Set whether or not to use the light inside the bowl unit.

<p>When set to "ON"</p> <p>Press "Rear washing" button.</p> <p></p> <p>Short beep</p>	<p>When set to "OFF"</p> <p>Press "Front washing" button.</p> <p></p> <p>Long beep</p>
---	---

Settings complete

CLEAN indicator

Set whether or not to light up the CLEAN indicator

1. ■ and +

Press and hold both the "Stop" button and "Water pressure adjustment +" button until the remote control LEDs are lit or flashing. (about 10 seconds)

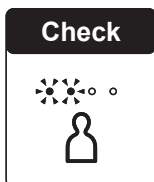

2.  



Press "Rear washing" button.

3. -

Press "Water pressure adjustment -" button.

4. Choose and press the button of the item that you want to set.

Set whether or not to light up the CLEAN indicator

When set to "ON" Press "Rear washing" button.  Short beep	When set to "OFF" Press "Front washing" button.  Long beep
---	--

Settings complete

Beep sound

Set whether or not to make a beep sound

1. ■ and +

Press and hold both the "Stop" button and "Water pressure adjustment +" button until the remote control LEDs are lit or flashing. (about 10 seconds)

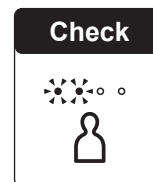

2. -

Press "Water pressure adjustment -" button.

3.  

Press "Rear washing" button.

4. Choose and press the button of the item that you want to set.

Set whether or not to make a beep sound.

When set to "ON" Press "Water pressure adjustment +" button. + Short beep	When set to "OFF" Press "Water pressure adjustment -" button. - Long beep
--	--

Settings complete

Changing Settings

Pressure / position setting

Set whether or not to keep your favorite pressure and position settings

1. ■ and +

Press and hold both the "Stop" button and "Water pressure adjustment +" button until the remote control LEDs are lit or flashing. (about 10 seconds)

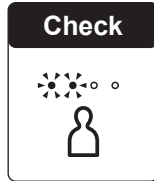

2. 

Press "Rear washing" button.

3. +

Press "Water pressure adjustment +" button.

4. -

Press "Water pressure adjustment -" button.
▶ The current setting is displayed.

5. -

Press "Water pressure adjustment -" button.
▶ The setting changes each time the button is pressed once.

Pressure/Position setting

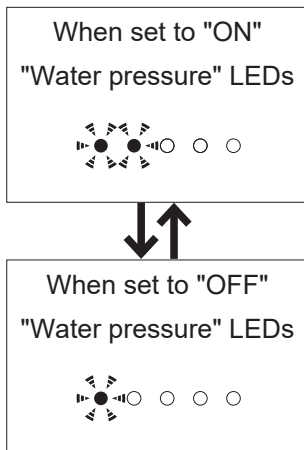

6. ■

Press "Stop" button.
Settings complete

Personal setting

Set whether or not to use the personal setting

1. ■ and +

Press and hold both the "Stop" button and "Water pressure adjustment +" button until the remote control LEDs are lit or flashing. (about 10 seconds)

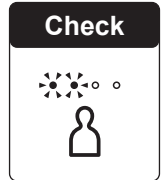

2. -

Press "Water pressure adjustment -" button.

3. +

Press "Water pressure adjustment +" button.

4. 

Press "Front washing" button.
▶ The current setting is displayed.

5. -

Press "Water pressure adjustment -" button.
▶ The setting changes each time the button is pressed once.

Personal setting

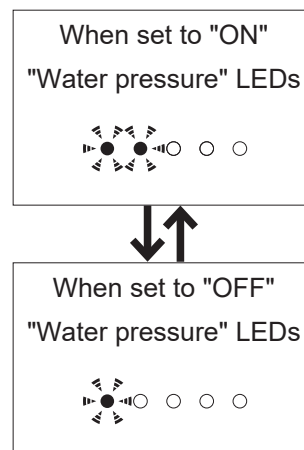

6. ■

Press "Stop" button.
Settings complete

Registering Personal Settings^{*1}

Register your preferred wand position, etc.

1.

Press "Personal setting" button.

Select the location to be set

- ▶ The setting changes each time the button is pressed once.

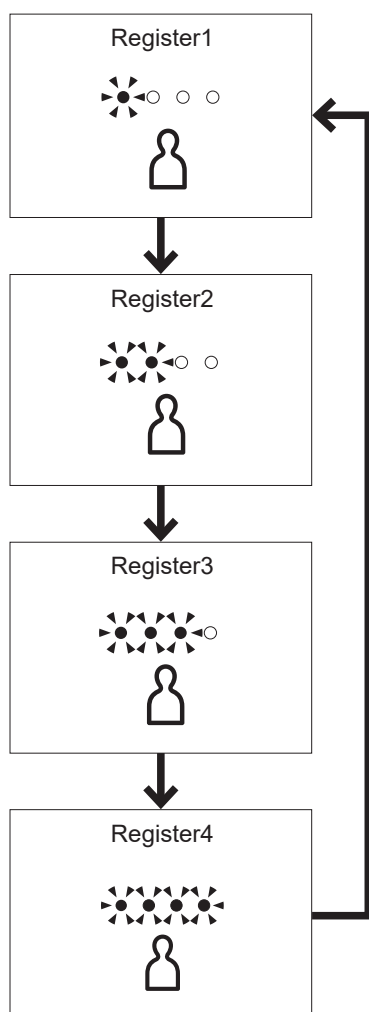

- ### 2.
- Set your preferences for "Wand position", "Water pressure" and "Warm water temperature" during "Rear washing", etc.

3.

Press "Personal setting" button about 5 seconds or longer. (Short beep)

Settings complete

^{*1} Cannot be performed when "Personal setting" is set to "OFF".

Changing Settings

Sensor detection range

You can change when to open the toilet lid upon entering the bathroom

1. ■

Press "Stop" button until all LEDs on the remote control are lit or flashing. (about 10 seconds)

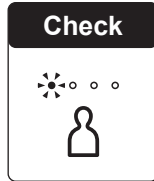

2.

Press "Front washing" button.

3.

Press "Rear washing" button.

4.

Press "Front washing" button.
▶ The current setting is displayed.

5. - and +

Use the "Water pressure adjustment -" and "Water pressure adjustment +" buttons to select [SET 1], [SET 2], [SET 3], [SET 4], or [SET 5].

▶ The setting changes each time the button is pressed once.

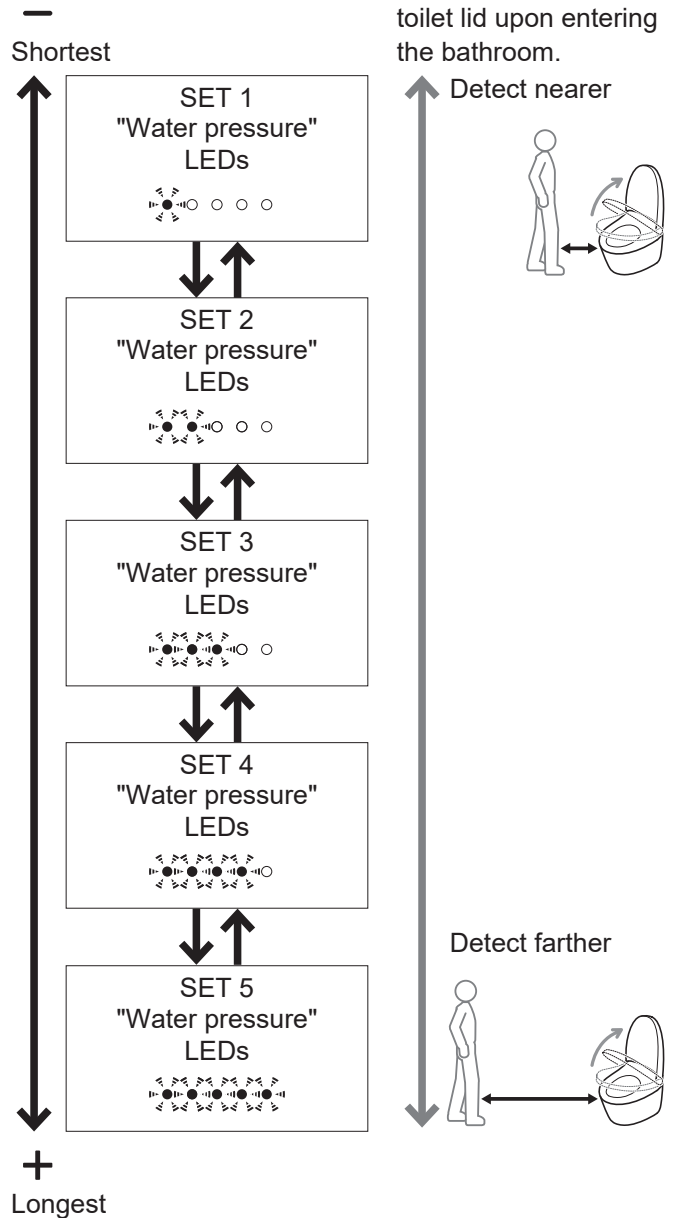

(Example)
When to open the toilet lid upon entering the bathroom.

Detect nearer

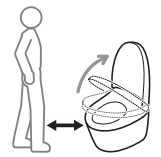

Detect farther

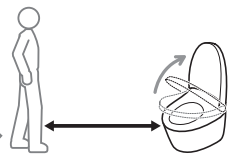

6. ■

Press "Stop" button.
Settings complete

Maintenance

Before maintenance

WARNING

Always turn off the power before maintenance or inspection.

Failure to do so may cause electric shock or malfunction, resulting in a breakdown.

For safety, turn the power OFF before maintenance.*1*2

When the power is turned OFF, the Power LED is unilluminated.

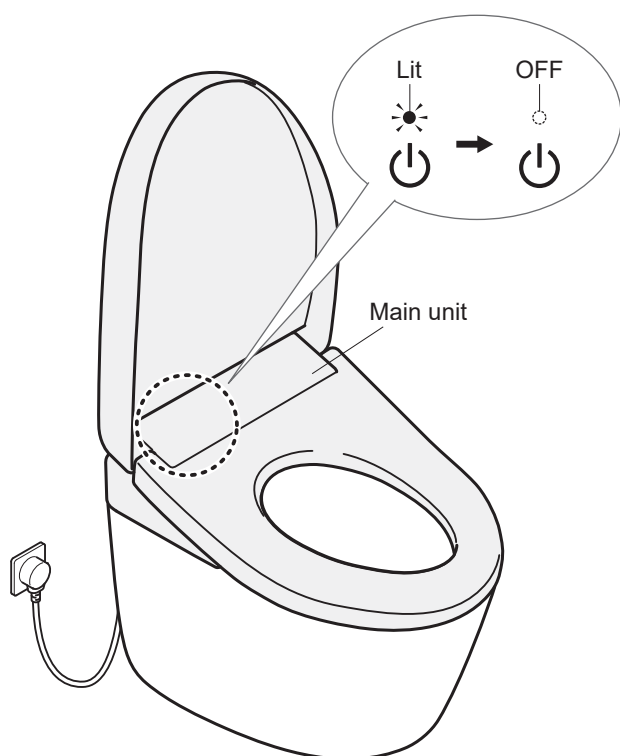

To turn the power "OFF"

Unplug the power plug.

To turn the power "ON"

Insert the power plug.

► The "Power" LED illuminates.

Power Plug

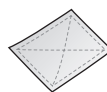

• Dry cloth



• Wet cloth

Approximately once a month

1. Unplug the power plug and wipe it with a dry cloth.



2. Insert the power plug.
 - The "Power" LED illuminates.

WARNING

Periodically remove dust from the blades and other parts of the power plug.

Unplug the power plug and wipe it with a dry cloth.

Fully insert the power plug.

When unplug the power plug, hold the main body of the power plug.

Pulling the power cord may damage the power plug or power cord.



*1 Except when using "Wand cleanig", "Manual spray".

*2 The toilet lid does not open automatically for about 20 seconds after the power is turned ON (preparing). Operate with the remote control. (Except SW4726AT40, SW4726, SW4724AT40, SW4724, SW4725)

Maintenance

Main Unit



- Soft cloth soaked in water

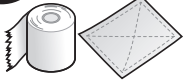

- Toilet paper
 - Dry cloth
 - Nylon scrubbing brush
- May cause damage.

Approximately daily

1. Turn the power "OFF". (→Page 47)

2. Wipe with a soft cloth that has been soaked in water and wrung out thoroughly.

For heavy dirt

Wipe with a soft cloth soaked in diluted, pH neutral kitchen detergent, and then wipe with a soft cloth soaked in water.

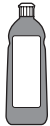

- pH neutral kitchen detergent



- Paint thinner
- Benzene
- Powdered cleanser

3. Turn the power "ON". (→Page 47)

- ▶ The "Power" LED illuminates.

Attention

This product is an electric appliance. Be careful not to let water seep inside or leave detergent in the gap between the main unit and bowl unit.

Do not put any cleaning solution directly onto the warm air outlet or cover around the wand, etc.

May damage plastic parts or cause a malfunction.

When using a toilet cleaner to clean the toilet, rinse it off within 3 minutes and leave the toilet seat and toilet lid open.

Wipe off any cleaner that remains on the bowl unit. If vapor from a toilet cleaner enters the main unit, it may cause a malfunction.

<If "Auto flush lid closed" (→Pages 34, 35) is turned ON> (→Page 10)

Do not press or pull the warm air outlet or cover around the wand with excessive force.

Doing so may cause damage or failure.

Wipe the back surface of the toilet seat and the toilet seat cushions with a soft cloth tightly wrung out with water.

Otherwise adhesion of dirt may result in discoloration.

Be sure to wipe off any water droplets on the toilet seat.

Otherwise, the seat sensor may malfunction.

Manual spray

EWATER+ mist can be sprayed to separate dirt from the surface for maintenance.

Approximately daily

<Manual spray>

Remote control back side

How to remove the remote control (→Page 18)

1) 

Press "Manual spray" button.

- ▶ EWATER+ mist is sprayed on the bowl unit.

Note: It cannot be used when the wand is out or when you are sitting on the toilet seat.

Gap between the Main Unit and Bowl Unit

You can remove the main unit to clean the top of the bowl unit and the bottom of the main unit.



- Soft cloth soaked in water



- Toilet paper
 - Dry cloth
 - Nylon scrubbing brush
- May cause damage.

Approximately once a month

1. Turn the power "OFF". (→Page 47)

CAUTION

If the power is not turned off, the unit may malfunction, causing a failure or electric shock.

2. Remove the main unit.

Pull the main unit toward you while pressing the "Main unit removal button".

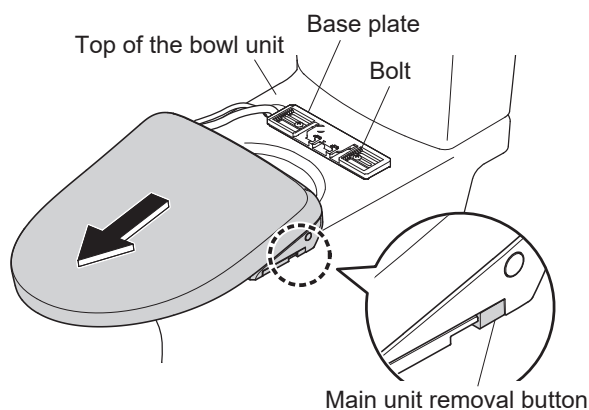

Attention

- Do not pull the unit with undue force.**
Because the water supply hose and power cord are attached.
- Do not excessively bend the water supply hose.**

3. Clean the top of the bowl unit and the bottom of the main unit.

Wipe with a soft cloth soaked in a diluted, pH neutral kitchen detergent. Then, dry the surface with a soft cloth soaked in water so that no detergent remains.

4. Mount the main unit.

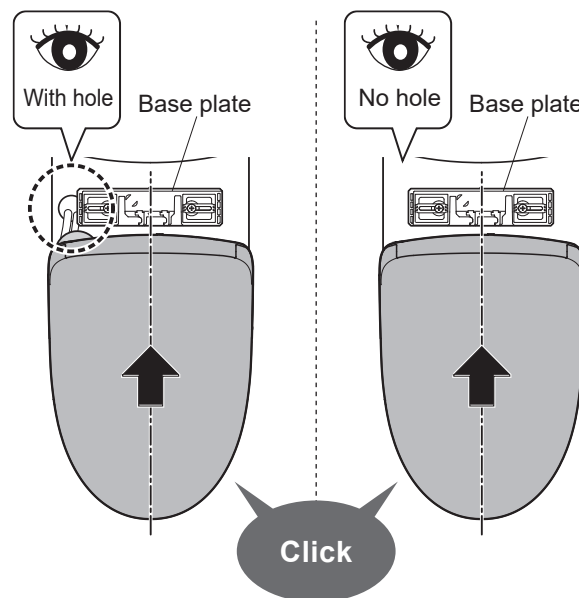

- 1) Pull the power cord and water supply hose into the recess on the bowl unit.
 - 2) Align the main unit with the center of the base plate and press it firmly onto the base plate until a click sound is heard.
- Align the main unit with the center of the base plate and press it firmly onto the base plate until a click sound is heard.

Attention

- Be careful not to pinch the power cord.**
- Do not excessively bend the water supply hose.**

CAUTION

- Push the main unit firmly on to the base plate until a click sound is heard.**
Doing so may cause the main unit to come loose and fall, resulting in injury.

- ▶ After mounting, check that the main unit does not detach even when pulled.

5. Turn the power "ON". (→Page 47)

- ▶ The "Power" LED illuminates.

Maintenance

Gap between the Main Unit and the Toilet Lid

The toilet lid can be removed for thorough cleaning.



- Soft cloth soaked in water

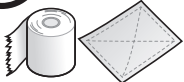

- Toilet paper
 - Dry cloth
 - Nylon scrubbing brush
- May cause damage.

Approximately once a month

1. Turn the power "OFF" and remove the main unit. (→Page 47)

2. Remove the toilet lid.

Slightly tilt the toilet lid to the front.

- A Pull left side outward.
- B Disconnect the hinge from the tab and pull up.
- C Disconnect the right side.

Hold with both hands

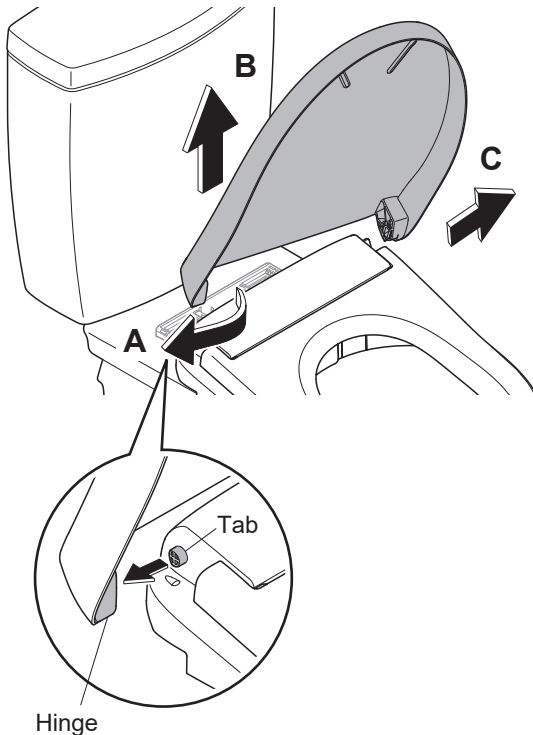

3. Wipe with a soft cloth that has been soaked in water and wrung-out thoroughly.

4. Reinstall the toilet lid.

- D Align the right side pin and hinge parts. Slightly tilt the toilet lid to the front.
- E While pulling left side outward.
- F Mount by joining the hinge with the tab.

Attention

Be careful not to pinch your fingers.

Hold with both hands

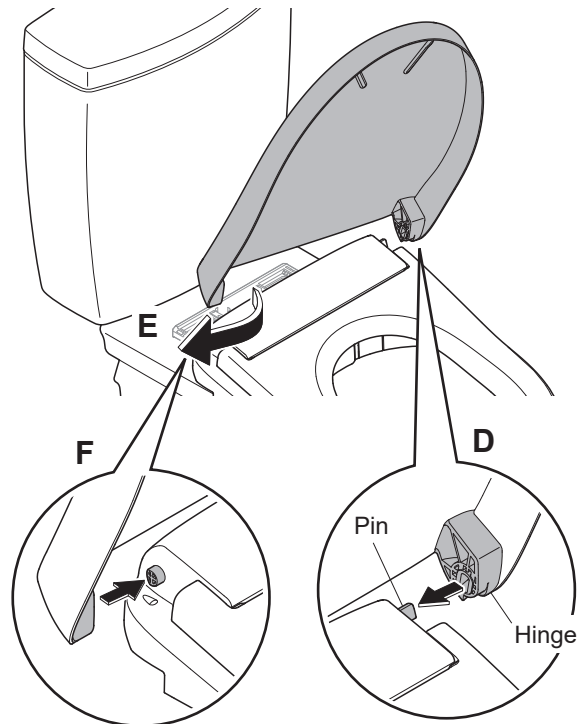

5. Reinstall the main unit and turn the power "ON". (→Page 47)

▶ The "Power" LED illuminates.

6. Open and close the toilet lid to check the reinstallation.

Wand



- Soft cloth soaked in water

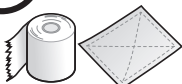

- Toilet paper
- Dry cloth
- Nylon scrubbing brush

May cause damage.

Approximately once a month If you notice dirt (Wand cleaning)

1. Extend the wand.

To operate from the back of remote control

Remote control back side



How to remove the remote control (→Page 18)





- 1) Press "Wand cleaning" button.

To operate from the front of remote control

Recommended if the remote control is secured to prevent theft, etc.

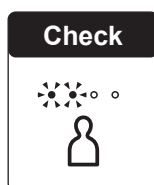
- 1)  and 
Press and hold both the "Stop" button and "Water pressure adjustment +" button until the remote control LEDs are lit or flashing. (about 10 seconds)



- 2) 
Press "Water pressure adjustment +" button.

- 3) 
Press "Front washing" button.

- 4) 
Press "Rear washing" button.

- ▶ The wand extends and water sprays out for cleaning.
- ▶ The wand automatically retracts after about 5 minutes.

2. Wipe with a soft cloth that has been soaked in water and wrung out thoroughly.

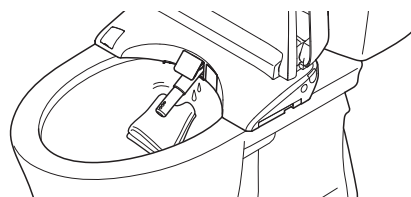

Attention

Do not pull, push or press the wand with excessive force.

May cause damage or malfunction.

3. 
Press "Stop" button.
▶ The wand retracts.

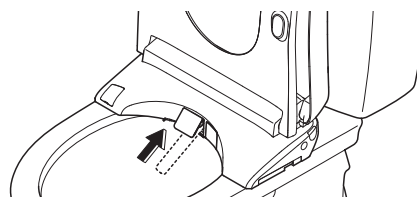

Maintenance

Deodorizing Filter

Approximately once a month

1. Turn the power "OFF". (→Page 47)

2. Remove the deodorizing filter.
Hold the tab and pull outward.

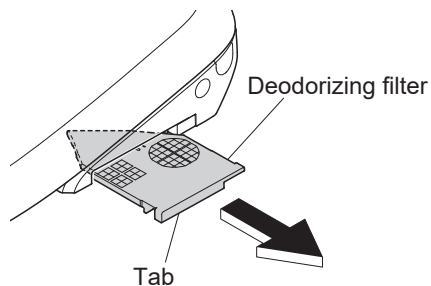

Attention

Do not pull the unit with undue force.
Doing so may cause damage or malfunction.

3. Clean with a tool such as a toothbrush.
▶ When washing with water, dry off all water before reinserting.

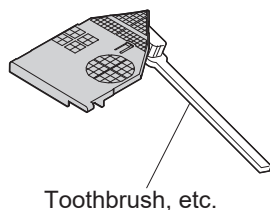

4. Reinsert the deodorizing filter.

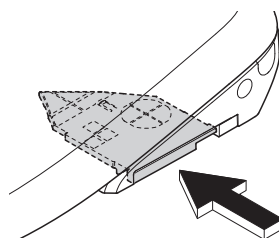

Push firmly until a click sound is heard.

5. Turn the power "ON". (→Page 47)

▶ The "Power" LED illuminates.

Drain plug with water supply filter

Approximately once every 6 months
If you think the water pressure has weakened

1. Close the shutoff valve. (→Page 59)
 - ▶ The water supply stops.

CAUTION

Do not remove the drain plug with water supply filter while the shutoff valve is open.
Otherwise, water may leak out.

2.  Press "Wand CLEAN" button.
(Release the pressure from the water supply pipe.)

3. Turn the power "OFF". (→Page 47)

4. Open the toilet seat and lid.

5. Open the cover and remove the drain plug with water supply filter.

- 1) Insert a flat-head screwdriver in the hook of the cover to open it.

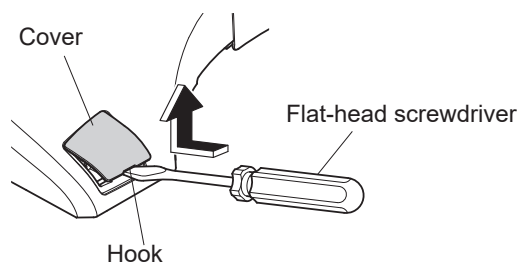

- 2) Loosen the drain plug with water supply filter with a flat-head screwdriver and then pull it.

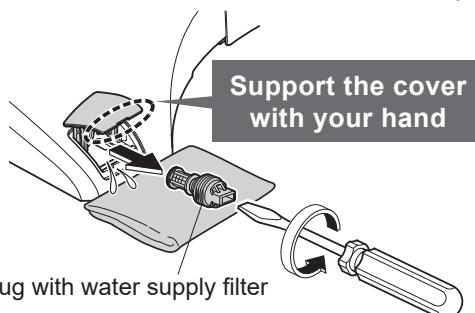

Drain plug with water supply filter

6. Clean the filter with a tool such as a toothbrush.
 - ▶ Also, remove any dust from inside the hole of the drain plug with water supply filter.

7. Reinstall the drain plug with water supply filter and close the cover.

- 1) Insert the drain plug with water supply filter and use a flat-head screwdriver to tighten it securely.

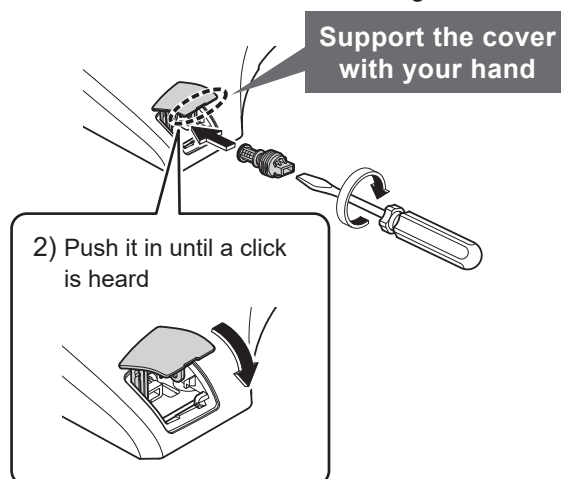

8. Turn the power "ON". (→Page 47)

- ▶ The "Power" LED illuminates.

9. Open the shutoff valve. (→Page 19)

What to Do?

If the water does not flow due to a water service interruption

Make sure to also check the instruction manual of your bowl unit.

1. Use a bucket to flush the bowl unit.

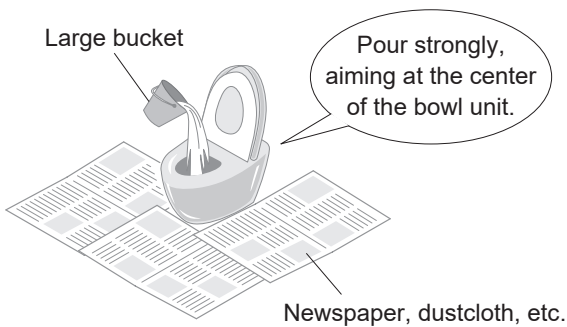

2. If the water level is low after flushing, add more water.
(Until the water level does not rise further.)
▶ Prevents odors.

Attention

Before starting work, turn "Auto flushing"*1 OFF.
(→Page 33)

When the water supply is restored, make sure to first use water in the bath or kitchen (not with this product) to remove air from the water supply pipes.

Otherwise, air or foreign objects may enter this product, causing failure.

After that, be sure to perform a full flush.

To prevent waste from remaining in the drain pipe.

If you cannot operate with the remote control

If the low battery warning mark "  " on the surface of the remote control is flashing, please replace the batteries.

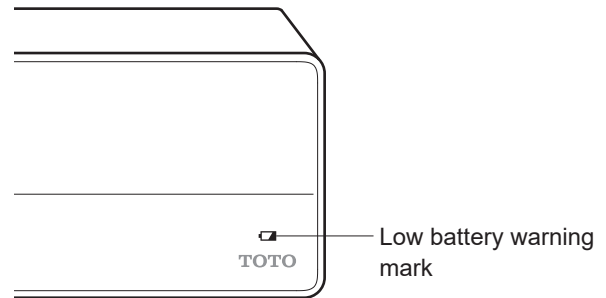

Replacing the batteries

1. Turn the power "OFF". (→Page 47)
2. Remove the remote control from the hanger.
(→Page 18)
3. Open the battery cover and replace with two new AAA batteries. (→Page 18)
▶ The low battery warning mark is unilluminated.
4. Mount the remote control in the hanger.
(→Page 18)
5. Turn the power "ON". (→Page 47)
▶ The "Power" LED illuminates.

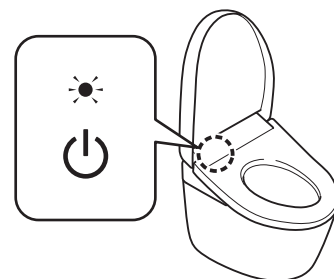

Attention

"ON" and "OFF" settings of the functions such as the energy saver function may be canceled when the batteries are replaced.
Set them again.

*1 Available only when "Flush" button is located on the top side of the remote control. (→Page 24)

Freeze Damage Prevention

When the ambient temperature is likely to drop to 32 °F (0 °C) or lower, take measures to prevent freezing.

Attention

When the ambient temperature is likely to drop to 32 °F (0 °C) or lower, do not use the energy saver feature.
May damage the product.

Warm the bathroom or take measures against freezing so that the ambient temperature does not drop below 32 °F (0 °C).

Before starting work, set "Auto flushing" ^{*1} (→Page 33) and "Auto open/close" ^{*2} (→Page 37) to "OFF".

1. Close the shutoff valve. (→Page 59)
▶ The water supply stops.

CAUTION

Do not remove the drain plug with water supply filter while the shutoff valve is open.
Otherwise, water may leak out.

2. Drain the water from the toilet tank.
Manipulate the lever/button/etc. until the water stops.

3.  Press "Wand CLEAN" button.
(Release the pressure from the water supply pipe.)

4. Turn the power "OFF". (→Page 47)

5. Drain the pipe.
1) Open the toilet seat and lid.

- 2) Insert a flat-head screwdriver in the hook of the cover to open it.

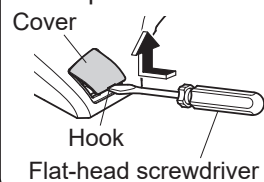

- 3) Loosen the drain plug with water supply filter with a flat-head screwdriver and then pull it.

Support the cover with your hand

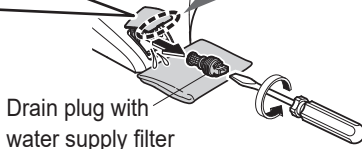

- 4) Only if the water supply hose is exposed on the side of the main unit.
Drain the water from the water supply hose.

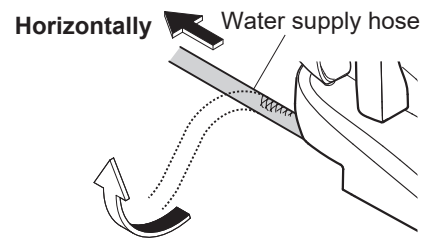

6. Reinstall the drain plug with water supply filter and close the cover.

- 1) Insert the drain plug with water supply filter and use a flat-head screwdriver to tighten it securely.

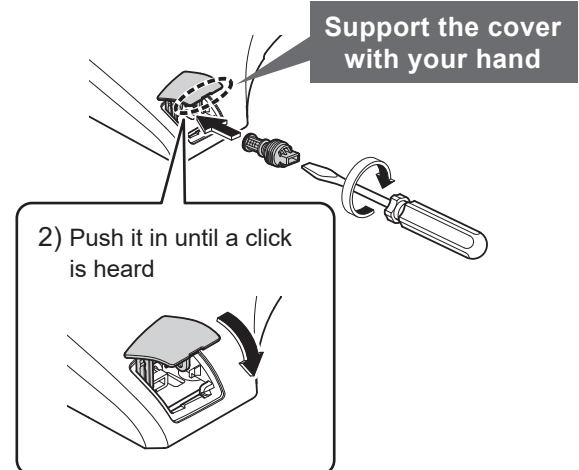

7. Turn the power "ON". (→Page 47)
▶ The "Power" LED illuminates.

8. Set the toilet seat temperature to "High". (→Page 26)
▶ To maintain the temperature, close the toilet seat and toilet lid after finishing work.

To use the product again

- ▶ The water needs to be resupplied. (→Page 57)

*2 Except SW4726AT40, SW4726, SW4724AT40, SW4724, SW4725.

What to Do?

Long Periods of Disuse

If the toilet is in a location you will not visit for a long time, drain the water.

The water in the tank may cause malfunctions or become contaminated and cause skin irritation or other problems.

(The water may freeze, causing damage to the product.)

Attention

When there is a risk of freezing, take measures to prevent freezing. (→Page 55)

Otherwise, the product may break down.

How to drain the water

1. Close the shutoff valve. (→Page 59)
 - ▶ The water supply stops.

⚠ CAUTION

Do not remove the drain plug with water supply filter while the shutoff valve is open.

Otherwise, water may leak out.

2. Drain the water from the toilet tank.
 - Manipulate the lever/button/etc. until the water stops.

3.  Press "Wand CLEAN" button.
 - (Release the pressure from the water supply pipe.)

4. Turn the power "OFF". (→Page 47)

5. Drain the pipe.

- 1) Open the toilet seat and lid.
- 2) Insert a flat-head screwdriver in the hook of the cover to open it.

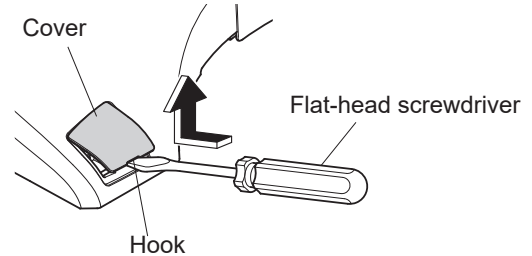

- 3) Loosen the drain plug with water supply filter with a flat-head screwdriver and then pull it.

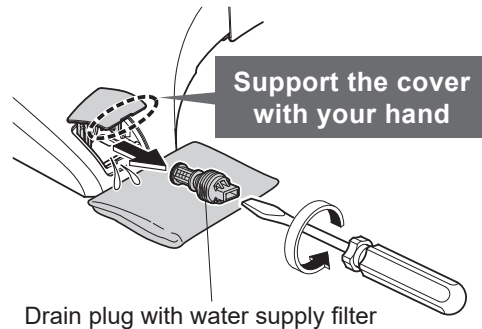

- 4) Only if the water supply hose is exposed on the side of the main unit.
 - Drain the water from the water supply hose.

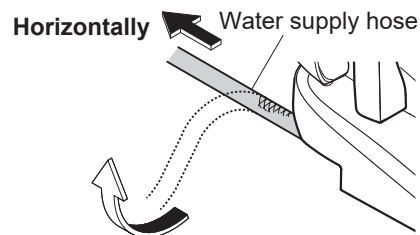

6. Reinstall the drain plug with water supply filter and close the cover.

- 1) Insert the drain plug with water supply filter and use a flat-head screwdriver to tighten it securely.

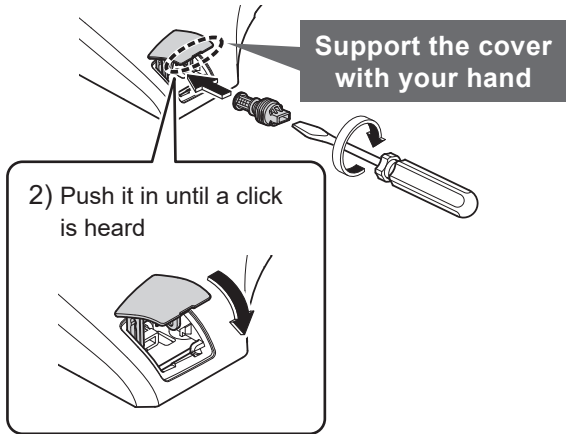

If water may get frozen

- ▶ Add antifreeze solution to the water in the bowl to prevent freezing.
(The antifreeze solution should not be flushed out. Collect it before using the toilet and dispose of it.)

To use the product again

- ▶ The water needs to be resupplied. (→see the right column)

Resupplying the Water

1. Open the shutoff valve. (→Page 19)
 - ▶ Check that water is not leaking from a pipe or the main unit.

2. If the power is not on, turn the power ON. (→Page 47)
 - ▶ The "Power" LED illuminates.

3. Discharge water from the wand.
 - 1) Keep your hand or arm in contact with the seat sensor. (→Refer to page 9)
 - 2)  Press "Rear washing" button to discharge water from the wand.
 - ▶ Catch the water in a paper cup or other receptacle.
 - 3) Move your hand or arm from the seat sensor

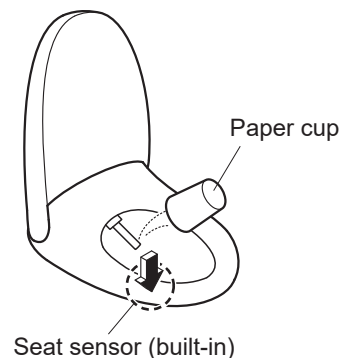

If the remaining water has frozen and no water comes out

- ▶ Heat the inside of the bathroom, and warm the water supply hose and shutoff valve using a cloth soaked in warm water.

What to Do?

How to remove the operation guide

To remove, follow the procedure below.

1. Turn the power "OFF". (→Page 47)
2. Remove the remote control from the hanger. (→Page 18)
3. Remove the hanger and operation guide.

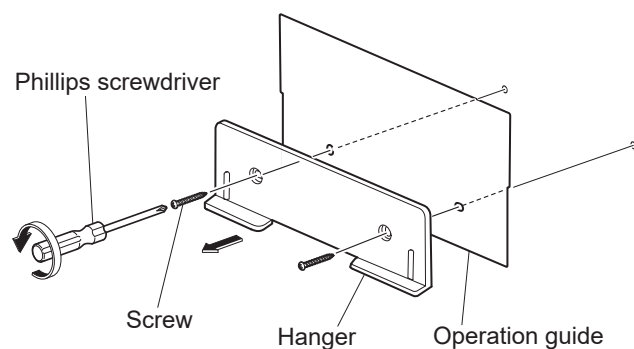

4. Screw the hanger on the wall.

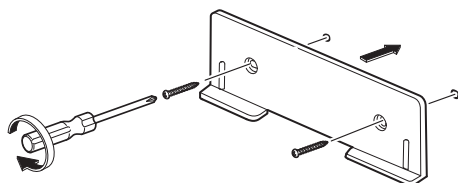

5. Mount the remote control in the hanger. (→Page 18)

6. Turn the power "ON". (→Page 47)
 - ▶ The "Power" LED illuminates.

To install back the operation guide, follow the procedure above.

- ▶ Install the operation guide at step 4.

Troubleshooting

First, try the actions described on pages 59–67. If the problem persists, consult the installer, seller or TOTO customer service (→see *contact information on the back cover*).

⚠ CAUTION

If a water leak occurs, close the shutoff valve.

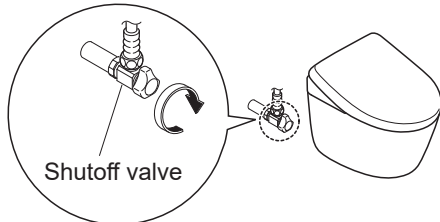

Please check first (A–C)

**A: Is the Power LED illuminated?
Is the main unit working?**

Is the breaker on the distribution board turned on?

- ▶ Check whether there is a power outage or the breaker has turned "OFF".

Is the "Power ON/OFF" setting "OFF"?

- ▶ Switch it to "ON" with the remote control. (→Page 19 step 2-2.2)

Is the "Power" LED on the main display flashing?

- ▶ The main unit is not mounted properly. Mount them correctly again. (→Pages 49)

B: Is the Energy saver LED lit?

- ▶ While the LED is lit, energy saver (→Pages 30, 31) is in operation, so the toilet seat temperature may be reduced or the heater may be turned off.

C: Is the remote control working?

Is the low battery warning mark  on the surface of the remote control flashing?

- ▶ Replace the batteries. (→Pages 18, 54)

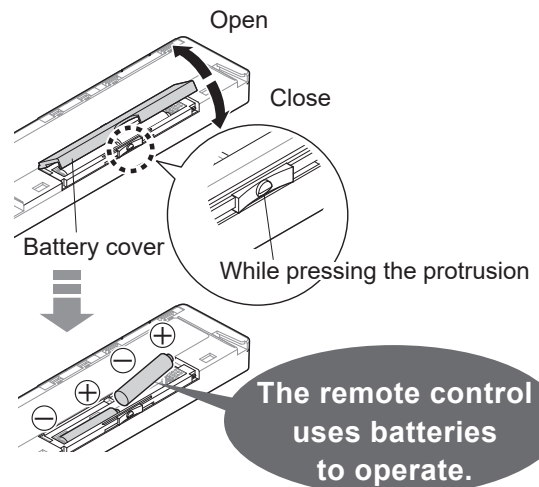

Is the remote control transmitter or the remote control receiver blocked?

- ▶ Remove obstructions, dirt, water droplets or any other blockages.

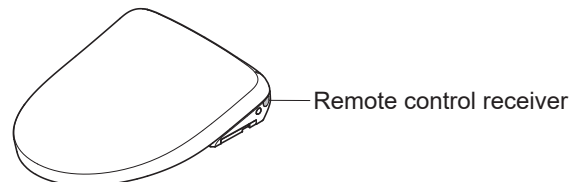
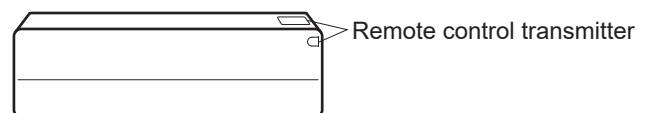

Troubleshooting

Rear Washing, Front Washing and Wand

Trouble	Please check
The wand (or washing water) does not come out	<p>When the temperature is low, it takes time for the wand to come out after the remote control button is pressed because the water must be warmed up first.</p> <hr/> <p>Has the toilet been sat "ON" and used continuously for 2 hours or longer? (If so, operation is stopped for safety purposes.)</p> <p>▶ Stand up from the seat and then use again.</p> <hr/> <p>If the water supply pressure drops significantly, for example if water is used elsewhere or if there is a water failure, the function may stop for safety.</p> <p>▶ Turn the power OFF and wait about 10 seconds before turning the power ON again. (→Page 19)</p> <p>If the above symptom reappears</p> <p>There may be a malfunction.</p> <p>▶ Consult the installer, seller, or TOTO customer service (→see contact information on the back cover).</p> <hr/> <p>When sitting on the toilet seat, is there a toilet seat cover or clothing on the seat sensor? Or are you sitting without touching the seat sensor?</p> <p>▶ Check the location of the seat sensor and sit down so that it touches your skin directly. (→Page 9)</p> <hr/> <p>Are you using a toilet seat cover, a toilet lid cover or a seat for infants?</p> <p>▶ Remove any covers. When using a seat for infants or a soft highchair, remove after each use. (→Page 10)</p> <div style="text-align: right;">  </div> <hr/> <p>✖✖ Are you pressing "Wand CLEAN" button?</p> <p>✖✖ When you press "Wand CLEAN" button, "EWATER+" comes out from the vicinity of the wand to clean the wand.</p> <p>▶ To clean the wand with it extended, perform "Wand cleaning". (→Page 51)</p>
The wand extends but the washing water does not come out / The washing water pressure is weak	<p>Has a water failure occurred?</p> <p>▶ ■ Press "Stop" button on the remote control and wait until water service is restored.</p> <hr/> <p>Is the shutoff valve closed?</p> <p>▶ Fully open the shutoff valve. (→Page 19)</p> <hr/> <p>Is the drain plug with water supply filter clogged with foreign matter?</p> <p>▶ Clean the filter. (→Page 53)</p> <hr/> <p>Is the water pressure set to a low level? (→Page 23)</p>
The washing water is cold	<p>Is the warm water temperature set to "OFF" or a low level? (→Pages 26, 27)</p> <hr/> <p>When the temperature of the water supply or the bathroom is low, the water temperature may be low when first sprayed.</p>
Stops in the middle of use	<p>"Rear washing", "Rear soft washing", "Front washing", and "Wide front washing" stop automatically after about 5 minutes of continuous use.</p> <hr/> <p>Does the seat sensor have difficulty detecting?</p> <p>▶ If you get up slightly from the seat or sit leftward on the seat, the seat sensor may temporarily stop detecting your presence, causing washing to stop prematurely. (→Page 9)</p>

Water comes out unexpectedly from the wand

When you sit on the toilet seat, water comes out for several seconds while water is warmed up.

Has the CLEAN indicator lit up in a cycle?

▶ "Auto wand CLEAN" starts and the wand is cleaned. (→Page 24)

Warm air drying**Trouble****Please check****The dryer temperature is low**

Is the dryer temperature set to low level? (→Page 26)

Stops in the middle of use

The feature stops automatically after about 10 minutes of continuous use.

Does the seat sensor have difficulty detecting?

▶ If you get up slightly from the seat or sit leftward on the seat, the seat sensor may temporarily stop detecting your presence, causing washing to stop prematurely. (→Page 9)

Flushing*1**Trouble****Please check****For not flushing**

Is the shutoff valve fully open? (→Page 19)

Has a water failure occurred?

▶ Use a bucket to flush water. (→Page 54)

The toilet does not flush even when the button of remote control is pressed

Are you pressing the button repeatedly?

▶ After pressing the flush button, operation will not be accepted for about 10 to 20 seconds.

The bowl unit does not clean automatically or timing is delayed (Auto flushing)

Is "Auto flushing" set to "OFF"?

▶ Set to "ON". (→Page 33)

Even if "Auto flushing" is set to "ON", it is not available in the following instances.

For about 60 seconds after the bowl unit flushes.

▶ After about 60 seconds have passed, use the remote control to flush the bowl unit. (→Page 24)

When the time spent sitting on the toilet seat is less than about 6 seconds.

▶ Use the remote control to flush the bowl unit. (→Page 24)

SW4736AT40, SW4736, SW4734AT40, SW4734

When the toilet is used in standing position.

▶ The water flows after a maximum of about 20 seconds from when you leave the bathroom.

▶ If "Auto flush lid closed" is turned ON, 30 seconds after leaving the bathroom, the toilet seat and lid close and then the bowl unit flushes.

SW4726AT40, SW4726, SW4724AT40, SW4724

If the body sensor has water droplets or dirt on it.

▶ Wipe off dirt.

*1 Available only when "Flush" button is located on the top side of the remote control. (→Page 24)

Troubleshooting

Flushing*¹ (continue)

Trouble	Please check
The bowl unit does not clean automatically or timing is delayed (Auto flushing)	<p>When sitting on the toilet seat, is there a toilet seat cover or clothing on the seat sensor? Or are you sitting without touching the seat sensor?</p> <p>▶ Check the location of the seat sensor and sit down so that it touches your skin directly. (→Page 9)</p> <hr/> <p>The timing for the "Auto flushing" can be changed. ([SET2] (Standard) → [SET1] (Short) or [SET3] (Long)) (→Page 34)</p>
The toilet flushes on its own	<p>Is "Auto flushing" set to "ON"?</p> <p>▶ You can turn it "OFF". (→Page 33)</p> <hr/> <p>Does the seat sensor or body sensor*² have difficulty detecting?</p> <p>▶ If you get up slightly from the seat or sit leftward on the seat, the seat sensor may not detect properly, causing the bowl unit to be flushed during use. (→Page 9)</p> <p>▶ Remove any dirt that is on the body sensor.*²</p> <hr/> <p>A light flush may be performed under the following conditions due to the bathroom layout, etc.*^{3,4}</p> <ul style="list-style-type: none"> • The toilet seat and lid are open and you stand in front of or walk past the front of the bowl unit. • "Auto open / close" is set to [Seat-Lid]. (→Page 38)

Toilet Seat and Toilet Lid (Auto open/close*³)

Trouble	Please check
The toilet lid does not open automatically	<p>Is "Auto open/close" set to "OFF"?</p> <p>▶ Set to "ON". (→Page 37)</p> <hr/> <p>Even when set to "ON", "Auto open/close" is not performed for about 15 seconds after the toilet seat or toilet lid is closed.</p> <p>When the toilet lid is closed with the remote control or by hand</p> <p>To make the product more user-friendly, a time interval is set from when the lid is closed to when it will open next.</p> <p>▶ Move away from the toilet and wait at least about 15 seconds before approaching the bowl unit again or open and close by hand. (→Page 24)</p> <hr/> <p>Is "Auto open delay" set to [SET 2] (Middle) or [SET 3] (Long)? (→Page 38)</p> <hr/> <p>The toilet lid does not open automatically for about 20 seconds after the power is turned ON.</p> <p>▶ Use the remote control to open or close it. (→Page 24)</p> <hr/> <p>Is a toilet lid or seat cover installed?</p> <p>▶ Remove any covers. (→Page 10)</p> <hr/> <p>If a function such as "Auto flushing" is operating, the body sensor may not detect properly.</p> <hr/> <p>You can change the detection range of the body sensor. (→Page 46)</p>
The toilet lid does not close automatically	<p>Is "Auto open/close" set to "OFF"?</p> <p>▶ Set to "ON". (→Page 37)</p> <hr/> <p>In the following cases, the toilet lid closes in about 5 minutes.</p> <ul style="list-style-type: none"> • When you did not sit on the toilet seat • When you sat on the toilet seat for less than 6 seconds

*1 Available only when "Flush" button is located on the top side of the remote control. (→Page 24)

*2 Except SW4736AT40, SW4736, SW4734AT40, SW4734.

*3 Except SW4726AT40, SW4726, SW4724AT40, SW4724, SW4725.

The toilet lid opens on its own	<p>Because the body sensor can detect movement through the wall or door in front of the toilet, the "Auto open/close" function may cause the toilet lid to open automatically even when you are outside of the bathroom.</p> <ul style="list-style-type: none"> ▶ You can also set "Auto open/close" to "OFF". (→Page 37) ▶ You can change the detection range of the body sensor. (→Page 46)
The toilet lid closes on its own	<p>Is a urinal or wash basin also installed in the bathroom?</p> <ul style="list-style-type: none"> ▶ The body sensor may detect someone using the urinal, causing the toilet lid to open or close. <hr/> <p>Is "Auto open/close" set to "ON"?</p> <ul style="list-style-type: none"> ▶ You can turn it "OFF". (→Page 37) <hr/> <p>Is "Auto close delay" set to [SET 1] (Short)? (→Page 37)</p> <hr/> <p>When sitting on the toilet seat, is there a toilet seat cover or clothing on the seat sensor? Or are you sitting without touching the seat sensor?</p> <ul style="list-style-type: none"> ▶ Check the location of the seat sensor and sit down so that it touches your skin directly. (→Page 9)
The toilet lid and toilet seat open at the same time	<p>Is "Seat/lid" set to "Seat·Lid"? (→Page 38)</p>
Stops (or closes) while opening	<p>If the toilet lid or seat hits an obstruction the first time it opens after the power is turned ON, it may stop (or close) partway during the next operation.</p> <ul style="list-style-type: none"> ▶ Eliminate any obstructions and turn the power OFF. Turn the power ON again after about 5 seconds. Then press the "Opening and closing the toilet lid" button on the remote control. (→Page 24)
The toilet lid does not close	<p>When the toilet lid closes may differ according to which functions are used.</p>
Cannot open or close with the remote control	<p>If it opens automatically.</p> <ul style="list-style-type: none"> ▶ Check "Is the remote control working?" (→Page 59) <hr/> <p>If automatic opening does not work either</p> <ul style="list-style-type: none"> • The toilet lid may not be mounted correctly. ▶ Mount them correctly. (→Page 49) <hr/> <p>Incorrect detection may occur when operating under fluorescent lights.</p>

Toilet Seat and Toilet Lid

Trouble	Please check
The toilet seat is cold	<p>Is the toilet seat temperature set to "OFF" or a low level? (→Pages 26, 27)</p> <hr/> <p>Is energy saver in operation?</p> <p>The energy saver feature is on when the "Energy saver" LED is on and the "Power" LED is off on the main display. When you sit on the seat, the toilet seat heater is turned on temporarily and the seat is warmed in about 15 minutes. (→Pages 30, 31)</p> <ul style="list-style-type: none"> ▶ You can turn it "OFF" if the energy saver feature is "ON". (→Pages 32, 33) <hr/> <p>Have you been seated for a long time?</p> <p>After about 20 minutes of sitting, the temperature starts going down, and after about 1 hour, the toilet seat heater is turned "OFF".</p> <ul style="list-style-type: none"> ▶ Stand up from the seat and then use again. <hr/> <p>Is a toilet lid or seat cover installed?</p> <ul style="list-style-type: none"> ▶ Remove any covers. (→Page 10)
The toilet seat and lid close on their own and then the bowl unit flushes*⁴	<p>Is "Auto flush lid closed" turned ON? (→Pages 34, 35)</p>

*4 If the "Flush" button is located on the top side of the remote control for SW4736AT40, SW4736, SW4734AT40, or SW4734.

Troubleshooting

Auto flush lid closed*1

Trouble	Please check
"Auto flush lid closed" does not activate	<p>Is "Auto flush lid closed" turned OFF? ▶ Turn it ON. (→Pages 34, 35)</p> <hr/> <p>If "Auto flush lid closed" is turned ON: Check the "Auto flushing" and "Auto open / close" settings. (→Pages 33, 37) Even if "Auto flushing" is turned ON, "Auto flush lid closed" does not activate in the following cases.</p> <p>For about 60 seconds after the bowl unit flushes. ▶ After about 60 seconds have passed, use the remote control to flush the bowl unit. (→Page 24)</p> <p>When the time spent sitting on the toilet seat is less than about 6 seconds. ▶ Use the remote control to flush the bowl unit. (→Page 24)</p> <p>When the toilet is used in standing position. ▶ About 30 seconds after you leave the bathroom, the toilet seat and lid close and then the bowl unit flushes.</p>
The toilet lid closes too early or too late	You can change "Auto flush delay" to modify the length of time before closing the toilet lid. ([SET 1] (Short) / [SET 2] (Standard) / [SET 3] (Long)) (→Page 34)

Auto flush lid relation*2

Trouble	Please check
"Auto flush lid relation" is not activated	<p>Is "Auto flush lid relation" turned OFF? ▶ Turn it ON.</p> <p>Even if "Auto flushing" is turned ON, "Auto flush lid relation" is not activated in the following case.</p> <p>For about 90 seconds after the bowl unit flushes. ▶ After about 90 seconds have passed, use the remote control to flush the bowl unit.</p>
The bowl unit flushes on its own	If "Auto flush lid relation" is turned ON and the toilet lid is not closed by hand, the bowl unit flushes automatically about 30 seconds after the user stands up in order to ensure flushing. (If "Auto flushing" is turned ON)

Energy Saver

Trouble	Please check
The Energy saver LED does not light up	<p>Has the power to the product been turned "OFF" or was there a power outage? The Energy saver LED on the main display may go off when the power is turned ON even if the energy saver feature is ON. It will turn on within about 24 hours since the setting is retained.</p>
The timer energy saver feature is not working	<p>Have the batteries in the remote control been replaced? "Timer energy saver" may be canceled when the batteries are replaced. ▶ Set the timer energy saver again at the time you want to start it. (→Page 33)</p>
The auto energy saver+ or auto energy saver feature is not working	<p>Because this function takes several days learning the usage conditions before starting energy saver, the amount of energy saving may be low, depending on the frequency of use. ▶ Check the energy saver setting. (→Pages 30, 31)</p>

*1 If the "Flush" button is located on the top side of the remote control for SW4736AT40, SW4736, SW4734AT40, or SW4734.

*2 If the "Flush" button is located on the top side of the remote control for SW4726AT40, SW4726, SW4724AT40, or SW4724.

Deodorizer

Trouble	Please check
The deodorizer seems to be not working	<p>Is "Deodorizer" set to "OFF"?</p> <p>▶ Set to "ON". (→Page 40)</p> <hr/> <p>Even after sitting down, you do not hear operation sounds.</p> <p>▶ Sit so your skin is in direct contact with the seat sensor. (→Page 9)</p> <p>If you hear an operation sound from the deodorizer, but odors are not removed.</p> <p>▶ Clean the deodorizing filter. (→Page 52)</p>
A strange odor is emitted	<p>Are you using an air freshener or deodorizer that you purchased separately?</p> <p>Doing so may reduce the effectiveness of the product's deodorizer or cause strange odors.</p> <p>▶ Remove the air freshener or deodorizer.</p>
The auto power deodorizer feature is not working	<p>Is "Auto power deodorizer" set to "OFF"?</p> <p>▶ Set to "ON". (→Page 40)</p> <hr/> <p>The auto power deodorizer starts about 10 seconds after you stand up from the toilet seat.</p>

Auto bowl CLEAN, Manual spray

Trouble	Please check
Pre-mist and aftermist do not work	<p>Is "Auto bowl CLEAN" set to "OFF"?</p> <p>▶ Set to "ON". (→Page 39)</p> <hr/> <p>The following functions do not work when the toilet seat is open.</p> <p>Is "Seat/lid" of "Auto open/close" set to "Seat·Lid"?^{*3}</p> <p>▶ You can change it to "Lid". (→Page 38)</p> <hr/> <p>SW4736AT40, SW4736, SW4734AT40, SW4734, SW4735</p> <p>If you use the pre-mist or after-mist immediately after the previous user leaves the bathroom, it may not be activated.</p> <hr/> <p>SW4726AT40, SW4726, SW4724AT40, SW4724, SW4725</p> <p>Pre-mist is not activated for about 90 seconds after after-mist finishes.</p> <p>Pre-mist is not activated when the toilet lid is closed upon entering the bathroom.</p> <p>▶ Open the toilet lid.</p>
The pre-mist sprays out spontaneously	<p>SW4736AT40, SW4736, SW4734AT40, SW4734, SW4735</p> <p>Because the body sensor can detect movement through the wall or door in front of the toilet, the "Auto bowl CLEAN" function may cause the toilet to pre-mist even when you are outside of the bathroom.</p> <p>▶ You can also set "Auto bowl CLEAN" to "OFF". (→Page 39)</p> <hr/> <p>SW4726AT40, SW4726, SW4724AT40, SW4724, SW4725</p> <p>Pre-mist is sprayed in the following cases.</p> <p>When the body sensor detects presence while the toilet lid is open</p> <p>When the toilet lid is opened by hand</p> <hr/> <p>If the washing functions (e.g., Rear washing and Front washing) are not used for about 8 hours, "Auto bowl CLEAN" starts and mist is sprayed inside the bowl unit.</p>

*3 Except SW4726AT40, SW4726, SW4724AT40, SW4724, SW4725.

Troubleshooting

Lights

Trouble	Please check
The soft light, bowl light and CLEAN indicator do not light up	Is the "Soft light", "Bowl light", or "CLEAN indicator" turned OFF? ▶ Set to "ON". (→Pages 42, 43)
The soft light lights permanently	Is "Night light" (Night mode) turned ON? ▶ If it is turned ON, the Soft light lights permanently. You can also turn it OFF [STANDBY]. (→Page 41)
"Night light" (Night mode) is not activated	Have the batteries in the remote control been replaced? "Night light" (Night mode) may be canceled when the batteries are replaced. ▶ Set them again. (→Page 41)

Others

Trouble	Please check
Water is leaking from the plumbing connections	If the nut of the connecting pipe is loosened, retighten it by hand. Do not use any tool. ▶ If the water leak does not stop, close the shutoff valve and consult with TOTO customer service. (→see contact information on the back cover)
The main unit is unstable	Are the bolts that anchor the main unit loose? ▶ Remove the main unit and then firmly tighten the base plate bolts.
The main unit makes a sound	<p>When entering the bathroom If "Auto bowl CLEAN" is "ON", you may hear that pre-mist is spraying mist in the bowl unit to make it more difficult for dirt to adhere. ▶ You can turn it "OFF". (→Page 39)</p> <p>When using the washing functions (Rear washing, Soft rear washing, or Front washing) You can hear the sound of the pump operating while washing water is being supplied.</p> <p>When moving away from the bowl unit after use When "Auto power deodorizer" is "ON", operation sounds are made while the deodorizing power increases for 60 seconds after you stand up from the toilet seat. ▶ You can turn it "OFF". (→Page 40)</p> <p>If "Auto wand CLEAN" is "ON" and you use the washing functions (e.g.,Rear washing and Front washing), you may hear that the wand is extended and cleaned with "EWATER+". ▶ You can turn it "OFF". (→Page 39)</p> <p>If "Auto bowl CLEAN" is "ON" and you sit on the toilet seat and use the toilet, you may hear that mist of "EWATER+" is sprayed inside the bowl unit. ▶ You can turn it "OFF". (→Page 39)</p> <p>You may hear that the wand is extended and the remaining water in the product is drained after "Auto wand CLEAN" and other functions are performed. You may hear the fan ventilating the unit. (About 30 minutes)</p>

The main unit makes a sound
When not using the product (e.g., at night)

You may hear the following sounds if "Auto wand CLEAN" or "Auto bowl CLEAN" is "ON" and if you do not use the washing functions (e.g., Rear washing and Front washing) for about 8 hours.

"Auto wand CLEAN" : Sound of cleaning the wand with "EWATER+".

: Sound of extending the wand and draining remaining water from the product after operation of functions.

"Auto bowl CLEAN" : Sound and operating noise of spraying EWATER+ mist on the bowl unit.

▶ You can turn it "OFF". (→Page 39)

Because the body sensor can detect movement through the wall or door in front of the toilet, the "Auto open/close" and "Auto bowl CLEAN" functions may cause the toilet to pre-mist, or the lid to open, even when you are outside of the bathroom.*1

▶ You can also set "Auto open/close" or "Auto bowl CLEAN" to "OFF".

(→Pages 37, 39)

▶ You can change the detection range of the body sensor. (→Page 46)

Operating noise may occur for extending the wand to prevent damage due to freezing by discharging the water remaining within the product.

The main unit cannot be operated through the remote control

Follow the instructions "Please check first (A–C)". (→Page 59)

The following conditions may affect the reception performance of the remote control, resulting in not being able to operate the main unit.

- When the room size, the layout of fixtures etc. interfere
 - When the color of the ceiling or walls is too dark, or their shape or material interfere
 - When there is a rack or cabinet installed on the wall behind the main unit
 - When an inverter lighting system is used
- ▶ Change the position of the remote control and try again.

*1 Except SW4726AT40, SW4726, SW4724AT40, SW4724, SW4725.

Specifications

Item	SW4736AT40 SW4736 SW4726AT40 SW4726	SW4734AT40 SW4734 SW4724AT40 SW4724	SW4735 SW4725
Rated power supply	AC 120 V, 60 Hz		
Rated power consumption	1290 W		1295 W
Maximum power consumption	1446 W		1453 W
Type of water heater	Instantaneous type		
Power cord length	3.9 ft (1.2 m)		
Water protection level	IPX4		
Washing			
Spray volume ^{*1}	Rear washing: Approx. 0.08 - 0.11 gal/min (Approx. 0.32 - 0.43 L/min) Rear soft washing: Approx. 0.08 - 0.11 gal/min (Approx. 0.32 - 0.43 L/min) Front washing: Approx. 0.08 - 0.11 gal/min (Approx. 0.29 - 0.43 L/min) Wide front washing: Approx. 0.09 - 0.11 gal/min (Approx. 0.35 - 0.43 L/min)		
Water temperature	Adjustable temperature range: OFF, about 86 - 104 °F (about 30 - 40 °C)		
Heater capacity	1116 W		
Safety device	Temperature fuse		
Backflow prevention device	Vacuum breaker, Check valve		
Heated seat			
Surface temperature	Adjustable temperature range: OFF, about 82 - 97 °F (about 28 - 36 °C) <Auto energy saver: about 79 °F (about 26 °C), Auto energy saver+: OFF>		
Heater capacity	50 W	55 W	
Safety device	Temperature fuse		
Deodorizer			
Method	O ₂ deodorization		
Airflow volume	Normal mode: Approx. 3.17 ft ³ /min (Approx. 0.09 m ³ /min) Power mode: Approx. 5.65 ft ³ /min (Approx. 0.16 m ³ /min)		
Power consumption	Normal mode: Approx. 1.6 W, Power mode: Approx. 4.0 W		
Warm air dryer			
Warm air temperature ^{*2}	Adjustable temperature range: about 95 - 140 °F (about 35 - 60 °C)		
Airflow volume	Approx. 8.83 ft ³ /min (Approx. 0.25 m ³ /min)		
Heater capacity	258 W		
Safety device	Temperature fuse		
Water supply pressure	Minimum required water pressure: 7.25 PSI (0.05 MPa) <Dynamic>, Maximum water pressure: 108.75 PSI (0.75 MPa) <Static>		
Water supply temperature	32 - 95 °F (0 - 35 °C)		
Working ambient temperature	32 - 104 °F (0 - 40 °C)		
Dimensions	W 1.26 x D 1.74 x H 0.34 ft (W 383 x D 530 x H 103 mm)	W 1.26 x D 1.74 x H 0.36 ft (W 383 x D 530 x H 109 mm)	W 1.26 x D 1.58 x H 0.34 ft (W 383 x D 482 x H 103 mm)
Weight	About 11 lb (about 5 kg)		

When disposing of this product, please follow your local or state guidelines for proper disposal.

*1 At 29 PSI (0.20 MPa) water pressure

*2 Temperature around the warm air outlet measured by TOTO.

Limited Warranty

One Year Limited Warranty

1. TOTO warrants its product to be free from defects in materials and workmanship during normal use when properly installed and serviced, for a period of one (1) year from date of purchase. This limited warranty is extended only to the ORIGINAL PURCHASER of the Product and is not transferable to any third party, including but not limited to any subsequent purchaser or owner of the Product. This warranty applies only to TOTO Product is purchased and installed in USA and Canada.
2. TOTO's obligations under this warranty are limited to repair, replacement or other appropriate adjustment, at TOTO's option, of the Product or parts found to be defective in normal use, provided that such Product was properly installed, used and serviced in accordance with instructions.
TOTO reserves the right to make such inspections as may be necessary in order to determine the cause of the defect. TOTO will not charge for labor or parts in connection with warranty repairs or replacements. TOTO is not responsible for the cost of removal, return and/or reinstallation of the Product.
3. This warranty does not apply to the following items:
 - a) Damage or loss sustained in a natural calamity such as fire, earthquake, flood, thunder, electrical storm, etc.
 - b) Damage or loss resulting from any accident, unreasonable use, misuse, abuse, negligence, improper care, or maintenance of the Product.
 - c) Damage or loss resulting from sediments or foreign matter contained in a water system.
 - d) Damage or loss resulting from the quality of water in the region where the product is used.
 - e) Damage or loss resulting from improper installation or from installation of the Product in a harsh and/or hazardous environment, or improper removal, repair or modification of the Product. This includes locations where the water pressure is above local codes or standards. (NOTE : Product model codes allow a maximum of 80 PSI. Check local codes or standards for requirements).
 - f) Damage or loss resulting from electrical surges or lightning strikes or other acts which are not the fault of TOTO or which the Product is not specified to tolerate, including failure to use the factory equipped cord and plug or use of a loose or faulty electrical outlet or use of a current or socket other than a 120 V, 60 Hz electrical current from a GFI (ground, fused) socket.
 - g) Damage or loss resulting from normal and customary wear and tear, such as gloss reduction, scratching or fading over time due to use, cleaning practices or water or atmospheric conditions, including but not limited to, the use of bleach, alkali, acid cleaners, dry (powder) cleaners or any other abrasive cleaners or the use of metal or nylon scrubbers.
4. If the Danger Label which has been placed over the seams on the back of the Products main unit is broken or otherwise not intact, this limited warranty is void.
5. In order for this limited warranty to be valid, proof of purchase is required. TOTO encourages warranty registration upon purchase to create a record of Product ownership at <http://www.totousa.com>. Product registration is completely voluntary and failure to register will not diminish your limited warranty rights.
6. If the Product is used commercially or is installed outside of USA or Canada. TOTO warrants the Product to be free from defects in materials and workmanship during normal use for one (1) year from the date of installation of the Product, and all other terms of this warranty shall be applicable except the duration of the warranty.
7. This warranty gives you specific legal rights. You may have other rights which vary from state to state, province to province or country to country.
8. To obtain warranty repair service under this warranty, you must take the Product or deliver it prepaid to a TOTO service facility together with proof of purchase (original sales receipt) and a letter stating the problem, or contact a TOTO distributor or products service contractor, or write directly to TOTO U.S.A., INC., 1155 Southern Road, Morrow, GA 30260 (888) 295 - 8134 or (678) 466-1300, if outside the U.S.A. If, because of the size of the Product or nature of the defect, the Product cannot be returned to TOTO, receipt by TOTO of written notice of the defect together with proof of purchase (original sales receipt) shall constitute delivery. In such case, TOTO may choose to repair the Product at the purchase's location or pay to transport the Product to a service facility.

WARNING! TOTO shall not be responsible or liable for any failure of, or damage to, this Product caused by either chloramines in the treatment of public water supply or cleaners containing chlorine (calcium hypochlorite).
NOTE: The use of a high concentrate chlorine or chlorine related product's can seriously damage the fittings. This damage can cause leakage and serious property damage.

THIS WRITTEN WARRANTY IS THE ONLY WARRANTY MADE BY TOTO. REPAIR, REPLACEMENT OR OTHER APPROPRIATE ADJUSTMENT AS PROVIDED UNDER THIS WARRANTY SHALL BE THE EXCLUSIVE REMEDY AVAILABLE TO THE ORIGINAL PURCHASER. TOTO SHALL NOT BE RESPONSIBLE FOR LOSS OF THE PRODUCT OR FOR OTHER INCIDENTAL, SPECIAL OR CONSEQUENTIAL DAMAGES OR EXPENSES INCURRED BY THE ORIGINAL PURCHASER, OR FOR LABOR OR OTHER COSTS DUE TO INSTALLATION OR REMOVAL, OR COSTS OF REPAIRS BY OTHERS, OR FOR ANY OTHER EXPENSE NOT SPECIFICALLY STATED ABOVE. IN NO EVENT WILL TOTO'S RESPONSIBILITY EXCEED THE PURCHASE PRICE OF THE PRODUCT. EXCEPT TO THE EXTENT PROHIBITED BY APPLICABLE LAW, ANY IMPLIED WARRANTIES, INCLUDING THAT OF MERCHANTABILITY OR FITNESS FOR USE OR FOR A PARTICULAR PURPOSE, ARE EXPRESSLY DISCLAIMED. SOME STATES DO NOT ALLOW LIMITATIONS ON HOW LONG AN IMPLIED WARRANTY LASTS, OR THE EXCLUSION OR LIMITATION OF INCIDENTAL OR CONSEQUENTIAL DAMAGES, SO THE ABOVE LIMITATION AND EXCLUSION MAY NOT APPLY TO YOU.

MEMO

MEMO